

Moulding

C A T A L O G



VOLUME 13

distributors of

QUALITY MOULDINGS
& ACCESSORIES

WWW.GARDENSTATELUMBER.COM

CONTENTS

Mouldings	2-85	Echon PVC Trimboards	166
Door Jambs	86	Echon PVC Sheet Stock	167
Metro Collection Mouldings	87-119	Echon PVC Mouldings	168-171
Designer Collection Mouldings	120-133	Prefinished Color PVC Trim	172-173
Hardwood S4S and Tongue & Groove Program	134-141	NuCedar Shingles and Siding	174-185
Hardwood Collection Mouldings	142-147	Melamine Sheets & Shelving	186
Custom Arches & Architectural Accents	148-149	S4S Products	187-189
Nantucket Beadboard	150-164	Sheet & Panel Products	190-191

MOULDING CONTENTS

1/2" x S4S	72	Drip Caps	74	Panel Moulding	62-66
Astragals & Mullion Centers	71	Edge & Center Bead Cap	69	Parting Strip	72
Back Bands	34	Edge & Center Beads	85	Picture Frame	71
Balusters	70	Edge Mouldings	72	Picture Mouldings	71
Band/Rake Mouldings	70	Extension Jambs	76	Plinth Blocks	35
Bar Rail	74	Exterior Casings	70	Poles	75
Base Cap/Panel	65-66	Flat Bottom Rail	75	Porch Rails	75
Bases	1-13	Floor Mouldings	3	Quarter Rounds	75
Base Shoes	2	Fluted Reeded Casings	33	Rope	75
Bed Mouldings	60	Glass Beads	72	Rosettes & Plinths	36
Brick Moulding	70	Half Rounds	75	Sanitary Caps	74
Bullnose	77	Hand Rail	75	Sills	77
Casings	17-32	Inside Corner	57	Shiplap	82
Casings/Bases	14-16	Landing Treads	78	Skew Backs	71
Cedar Closet Lining	78	Lattices	72	Stepping	78
Chair Rails	37-40	Mantel	78	Stools	76-77
Corner Guards	74	Melamine Sheets & Shelving	186	Stops	73
Cove Mouldings	60	Nose & Coves	63	T&G Nickel Gap	80
Crowns	41-56	Now Stocking	186	T&G V-Groove	80
Crown Backer	43	Oak Hearth Border	78	Tongue & Groove Edge & Center Beads	85
Crowns – Solid	58-59	Oak Nosing	78	Wainscot Caps	69
Dentil Mouldings	57	Oak Saddles	78	Yellow Pine Siding	79
Door Jambs – Interior	86	Oval Hand Rail	75	Yellow Pine T&G Flooring	79



Download the new *GSL App!* Searching for the perfect millwork package just got a lot easier.





MOULDING PROFILES

6P105.....	79	8746.....	19	D8090.....	73	GS119.....	22	M8753.....	71	PLC612.....	49	WM85.....	60
8P105.....	79	8753.....	18	D8121.....	73	GS400.....	24	MCA11.....	16, 66	PLC634.....	51	WM93.....	60
138BB.....	34	8900.....	70	DC400.....	25	GS419.....	27	MCA2.....	66	PLC712.....	54	WM97.....	22
693.....	3	8901.....	70	DC412.....	28	GS425.....	25	MCA34.....	66	PLC812.....	56	WM130.....	71
1268B.....	76	8902.....	70	DC450.....	28	GS434.....	29	MCA54.....	66	PLC1012.....	56	WM133.....	71
1274.....	76	8904.....	70	DC499.....	30	GS441.....	25	MCB5.....	5	PLP312.....	63	WM163.....	65
8013.....	42	8908.....	75	DC512.....	31	GS694.....	22	MCB7.....	9	PLR334.....	38	WM164.....	65
8016.....	60	8926.....	74	DC550.....	32	GSB412.....	5	MCB512.....	16	PM2200.....	24	WM180.....	70
8017.....	60	8938.....	76	DCAS5.....	31, 38	GSB512.....	8	MCB525.....	7	PPB512.....	36	WM197.....	74
8018.....	60	AB090.....	73	DCB8.....	12	GSB534.....	8	MCB712.....	16	PPB712.....	36	WM206.....	74
8024.....	60	AB121.....	73	DCB525.....	8	GSB725.....	10	MCB725.....	11	PWS612.....	77	WM209.....	58
8026.....	60	AB173.....	71	DCB534.....	9	GSC412.....	44	MCB81.....	34	PWS634.....	77	WM210.....	59
8027.....	42	AB926.....	74	DCB714.....	11	GSC512.....	48	MCB82.....	34	RAB297.....	69	WM212.....	70
8047.....	58	B34.....	65	DCB775.....	12	GSC614.....	49	MCC212.....	16, 20	RC214.....	33	WM217.....	70
8052.....	60	B608.....	65	DCB825.....	13	GSC738.....	53	MCC312.....	16, 21	RP12.....	75	WM230.....	75
8054.....	60	B658.....	65	DCB925.....	13	HB158.....	78	MCC334.....	23, 40	RP34.....	75	WM231.....	75
8057.....	75	B660.....	65	DCBB5.....	8	JC412.....	27	MCC375.....	23, 40	S2.....	74	WM265.....	72
8058.....	75	B662.....	59	DCLK5.....	30	L239.....	70	MCC412.....	16, 26	S4.....	71	WM281.....	34
8060.....	60	B672.....	72	DCR512.....	47	L265.....	72	MCC434.....	29, 40	S5.....	77	WM290.....	74
8061.....	60	B8090.....	73	DCR558.....	48	L623.....	4	MCC475.....	29, 40	S7.....	60	WM315.....	19
8062.....	60	B8121.....	73	DCR612.....	50	L634.....	4	MCC534.....	32	S8.....	75	WM327.....	19
8063.....	75	B8173.....	71	DCR634.....	51	L723.....	2	MCC575.....	32	S9.....	60	WM351.....	18
8064.....	75	B8712.....	4	DCR725.....	53	L724.....	2	MCOV5.....	44	S12.....	76	WM356.....	18
8065.....	75	B8712N.....	4	DCR734.....	55	L953.....	72	MCOV6.....	46	S16.....	76	WM361.....	18
8066.....	75	B8746.....	19	DCR814.....	55	L995.....	71	MCOV8.....	52	S18.....	76	WM376.....	18
8068.....	75	B8753.....	18	DCWC5.....	30	L1021.....	77	MCR514.....	46	S20.....	76	WM390.....	39
8070.....	75	BB6.....	9	DTL112.....	57	L1084.....	76	MCR550.....	47	S21.....	76	WM412.....	15
8071.....	75	BB7.....	10	DTL158.....	57	L8009.....	42	MCR650.....	50	S30.....	76	WM442.....	18
8072.....	75	BB138.....	65	DTL334.....	57	L8010.....	42	MCR714.....	52	S31.....	76	WM444.....	19
8073.....	75	BB414.....	5	DTL512.....	57	L8013.....	42	MCR750.....	54	S86.....	60	WM445.....	18
8076.....	75	BB458.....	5	E2E432.....	14	L8027PVC.....	42	MCS1.....	2, 66	SAD4.....	78	WM452.....	14
8077.....	75	BB514.....	6	E693.....	3	L8065.....	75	MCS125.....	58	SAD5.....	78	WM472.....	14
8080.....	75	BB514N.....	6	E8090.....	73	L8080.....	75	MCS225.....	58	SAD6.....	78	WM618.....	6
8121.....	73	BB518.....	7	EBV4.....	85	L8200.....	74	MCS275.....	58	SAD431.....	78	WM620.....	4
8144.....	73	BB714.....	10	EBV6.....	85	L8202.....	74	N138.....	78	SAD531.....	78	WM624.....	4
8186.....	39	BB738.....	11	ECB4.....	85	L8269.....	76	N8753.....	18	SAD631.....	78	WM662.....	4
8187.....	39	BBCAP12.....	34, 69	ECB6.....	85	L8279.....	72	NB514.....	7	SAN414.....	15	WM714.....	2
8200.....	74	BC5.....	45	ECB55.....	85	L8282.....	72	NG512.....	80	SAN525.....	15	WM750.....	15
8201.....	74	BC78.....	65	ECBCAP.....	34, 69	L8288.....	71	NG714.....	80	SAN725.....	15	WM753.....	15
8202.....	74	BDB25.....	15, 20	ES1.....	21	L8422.....	2	NG914.....	80	SBC514.....	45	WM875.....	73
8268.....	76	BDB35.....	15, 21	ES2.....	21	L8423.....	3	NVG514.....	80	SC134.....	58	WM876.....	73
8279.....	72	BDB45.....	14, 26	ES3.....	27	L8535.....	59	NVG8.....	80	SC214.....	58	WM887.....	73
8280.....	72	BDB55.....	14	ES4.....	25	L8712.....	4	NY102.....	71	SC234.....	58	WM888.....	73
8281.....	72	BDBCAP.....	14, 65	ES5.....	38	L8746.....	19	NY109.....	70	SH1.....	2	WM935.....	73
8282.....	72	BNS18.....	77	ES6.....	38	L8753.....	18	NY127.....	59	SHIP6.....	82	WM936.....	73
8288.....	71	BS134.....	63	ES7.....	38	L8938.....	76	NY128.....	59	SHIP8.....	82	WM938.....	73
8313.....	34	C103.....	19	ES8.....	38	L8940.....	77	NY212.....	70	SHIP10.....	82	WM1021.....	77
8409.....	65	C105.....	19	ES9.....	65	LF8834.....	75	OS12.....	78	SILLCT.....	77	WM1300.....	71
8412.....	65	C106.....	19	ES10.....	78	LF8835.....	75	P214.....	75	SILLNY.....	77	WM1305.....	71
8416.....	65	C8090.....	73	ES11.....	63	LK3.....	20	P329.....	75	SL6.....	82	WP101.....	60
8417.....	65	C8121.....	73	ES12.....	26	LK4.....	24	P514.....	33	SL8.....	82	WP140.....	72
8422.....	2	C8712.....	4	ES13.....	34	LS6.....	77	P714.....	33	STF1.....	19	WP210.....	59
8423.....	3	C8753.....	18	ES14.....	34	LT312.....	78	PB418.....	35	TW2.....	76	WP211.....	58
8427.....	3	CB34.....	57	ES15.....	63	LWM47.....	42	PB518.....	35	TW4.....	76	WP830.....	73
8432.....	72	CB312.....	43	ES16.....	34	LWM49.....	42	PB550.....	35	TWEJ.....	76	WP831.....	73
8462.....	70	CCL32.....	78	F8.....	75	LWM70.....	60	PL2.....	63	UC31.....	43	WP845.....	73
8463.....	70	CGM31.....	23	F233.....	75	LWM135.....	71	PL78.....	65	UC41.....	45	WP855.....	73
8469.....	70	CHIBAR.....	74	F693.....	3	LWM204.....	74	PL118.....	65	UC51.....	48	WP856.....	73
8470.....	70	COV7.....	53	F1021.....	77	LWM264.....	72	PL134.....	63	UC71.....	51	WP858.....	73
8535.....	59	COV312.....	43	F8282.....	72	LWM297.....	39	PL138.....	65	V66.....	85	WP925.....	73
8565.....	72	COV412.....	43	F8712.....	6	LWM321.....	19	PL378.....	24	V6725.....	80	WP995.....	71
8575.....	63	CSM.....	71	F8911.....	75	LWM390.....	39	PL458.....	28	W314.....	85	XLPECB6.....	85
8576.....	63	CTSHOE.....	2	F8912.....	75	LWM410.....	15	PL514.....	31	WC1.....	22	YFP13.....	79
8577.....	63	D1.....	72	F8913.....	75	LWM412.....	14	PLANK.....	59	WC1CT.....	23	YFP14.....	79
8578.....	63	D2.....	72	FR214.....	33	LWM432.....	14	PLB8.....	12	WC2.....	20	YFP16.....	79
8590.....	72	D3.....	72	FR314.....	33	LWM445.....	18	PLB9.....	13	WC78.....	69	YFP54.....	79
8610.....	72	D4.....	72	FS225.....	77	LWM445.....	18	PLB61.....	9	WC214.....	69		
8611.....	72	D5.....	72	FS312.....	77	LWM903.....	2, 73	PLB714.....	11	WM47.....	42		
8711.....	19	D10.....	70	G8090.....	73	LWM973.....	71	PLB8416.....	7	WM53.....	42		
8712.....	4	D693.....	2	G8282.....	72	LWP709.....	3	PLC99.....	49	WM81.....	60		

WWW.GARDENSTATELUMBER.COM

NORTHEAST REGION:
PHONE: (800)526-4708

SOUTHEAST REGION:
PHONE: (800)296-0288

WHERE MOULDINGS GO

ALL PROFILES SHOWN BELOW ARE FROM OUR METRO COLLECTION OF TIMELESSLY MODERN MOULDINGS.

crown/cove

crown backer

s4s/
breastboard

solid crown

casing header

panel cap

casing leg

chair rail or
panel cap

panel moulding

baseboard

shoe moulding

CROWN: MCOV8, MCC412, MCAP2

CHAIR RAIL: MCAP34

BASEBOARD: MCB712

CASING HEADER: MSC275, 1x8, MCAP2

PANEL MOULDING: MCAP2

SHOE MOULDING: MCS1

CASING LEG: MCC475



BASES



MCS1 Shoe used as cap, 1" x 6",
MCS1 Shoe Moulding



GSB534 Base with
SH1 Shoe Moulding



PLB9 Base with
LWM903 Shoe Moulding

BASE SHOES

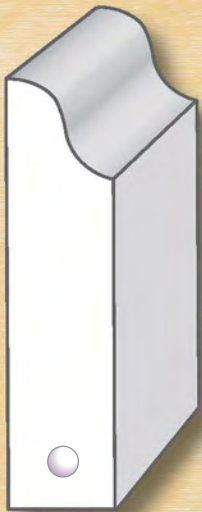

LWM903

9/16 x 2-1/4

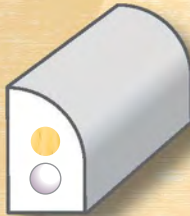

L8422

(WM129)
7/16 x 11/16



8422

(WM126)
1/2 x 3/4

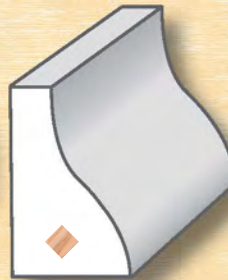

CTSHOE

5/8 x 1
CT Oak Shoe

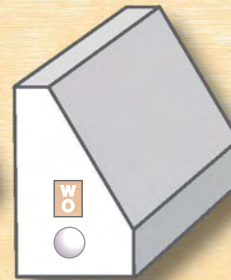

MCS1

5/8 x 1

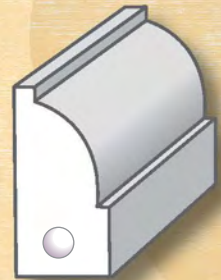

SH1

1/2 x 1

BASES CLAM SHELL

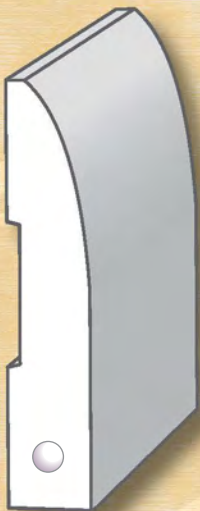

L723

7/16 x 2-1/4

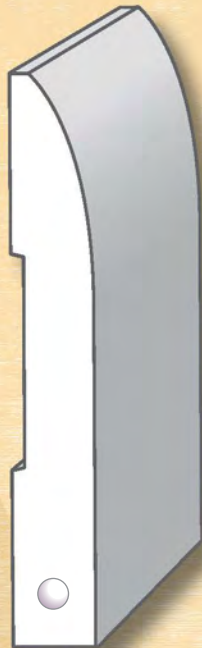

L724

7/16 x 3



WM714

9/16 x 3

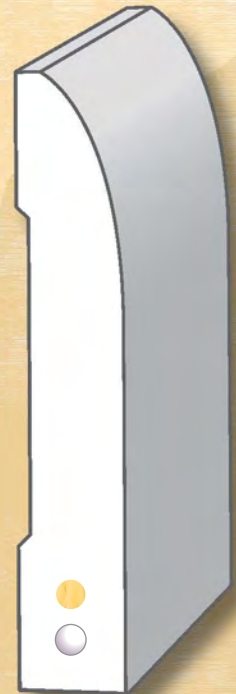

D693

(WM713)
9/16 X 3-1/4





MCB512 Base with
MCS1 Shoe Moulding



PLB612 Base with
8422 Shoe Moulding



PLB8 Base with
8423 Floor Moulding



FLOOR MOULDINGS

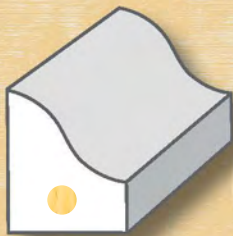

8427
5/8 x 3/4

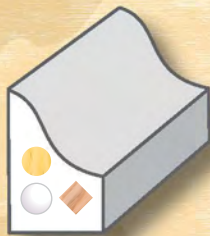

8423
1/2 x 3/4

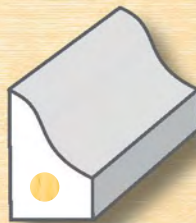

L8423
7/16 x 11/16

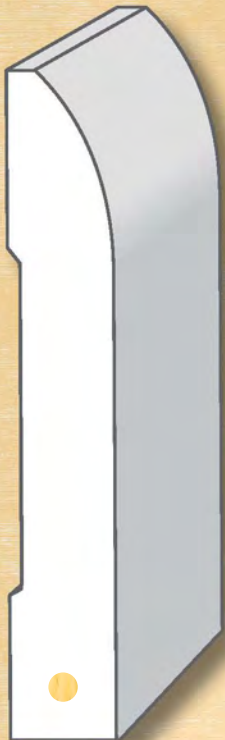

E693
9/16 x 3-1/2



693
11/16 x 3-1/2



F693
9/16 x 4-1/4

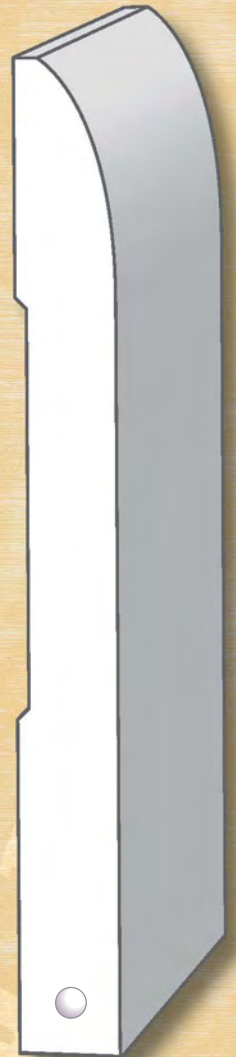

LWP709
9/16 x 5-1/4

WWW.GARDENSTATELUMBER.COM

BASES COLONIAL

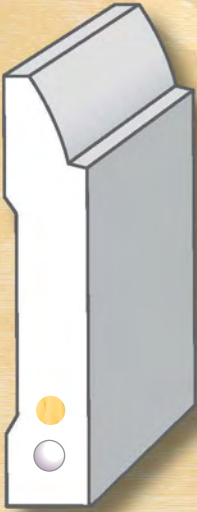

L634
7/16 x 2-1/4

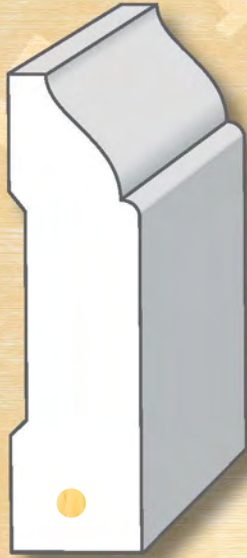

L623
11/16 x 2-1/2



L8712
7/16 x 3

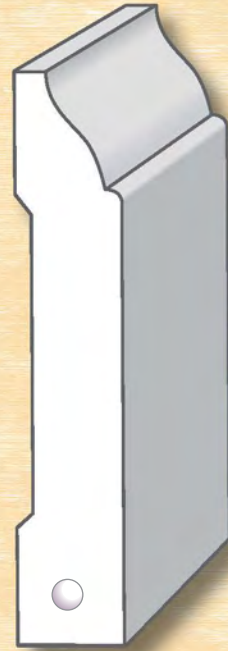

WM624
9/16 x 3

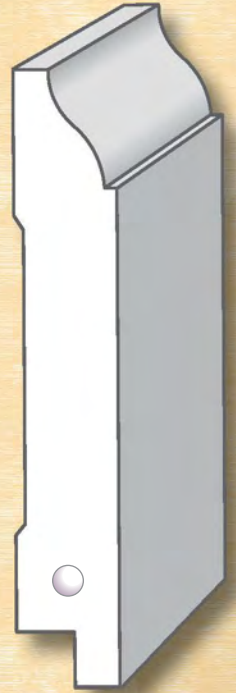

B8712N
9/16 x 3-1/4
(Rabbed)



B8712
9/16 X 3-1/4
(WM623)



WM662
9/16 x 3-1/2
Lamb's Tongue Base



C8712
9/16 x 3-1/2



8712
11/16 x 3-1/2

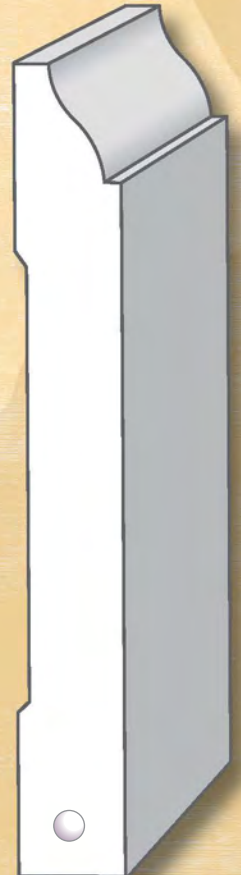

WM620
9/16 X 4-1/4

BASES



BB414



GSB412



BB458



MCB5

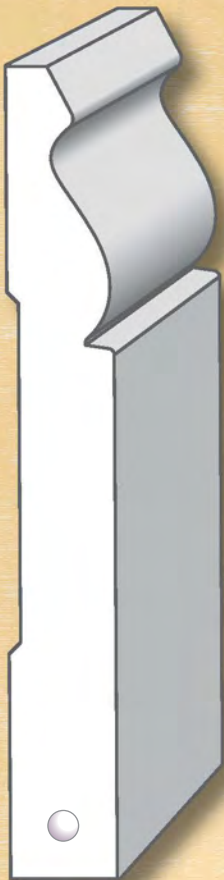

BB414

9/16 x 4-1/4



GSB412

5/8 x 4-1/2



BB458

11/16 x 4-5/8

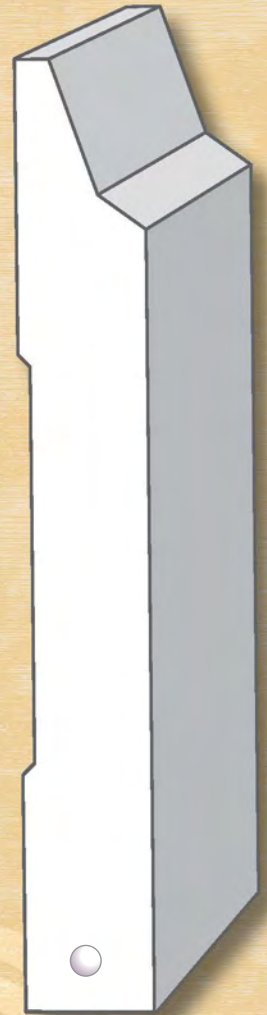

MCB5

11/16 x 5

BASES



WM618



F8712



BB514N



BB514

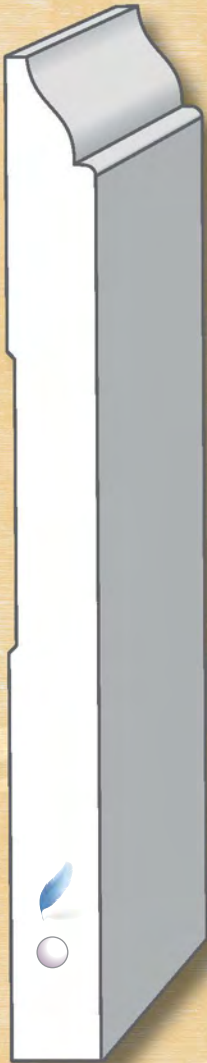

WM618

9/16 x 5-1/4 (Primed Pine)
1/2 x 5-1/4 (MDF)



F8712

11/16 x 5-1/4



BB514N

9/16 x 5-1/4
(Rabetted)

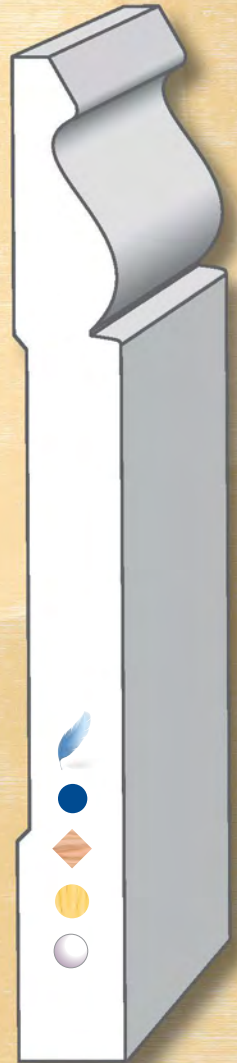

BB514

9/16 x 5-1/4



BASES



BB518



MCB525



PLB8416



NB514 with 8416 Base Cap



BB518

11/16 x 5-1/4

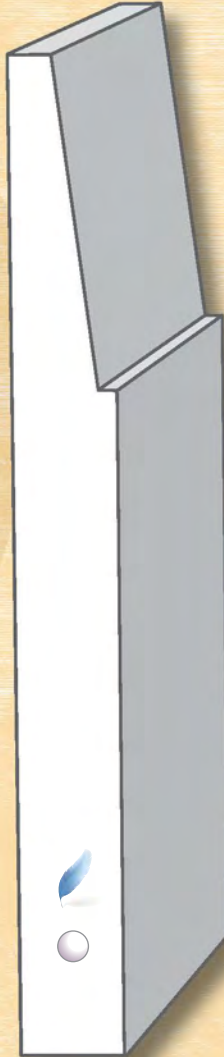

MCB525

9/16 x 5-1/4



PLB8416

5/8 x 5-1/4

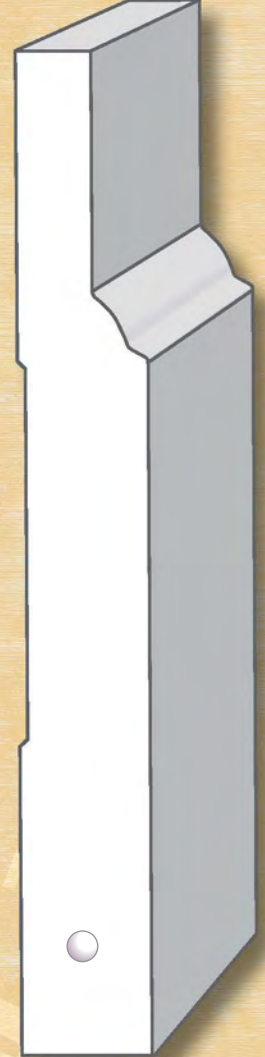

NB514

11/16 x 5-1/4

BASES



DCB525



GSB512



DCBB5



GSB534

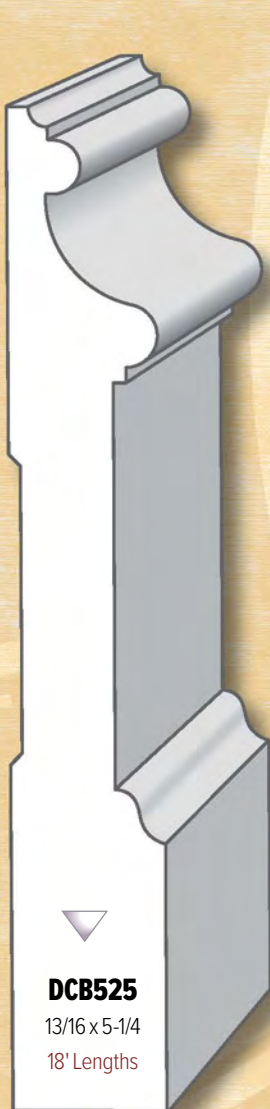

DCB525

13/16 x 5-1/4

18' Lengths

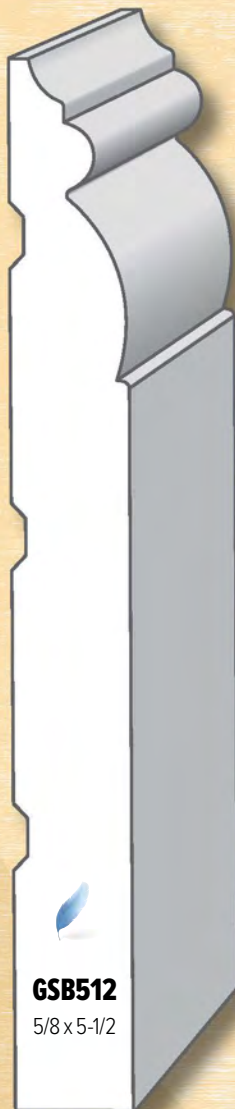

GSB512

5/8 x 5-1/2

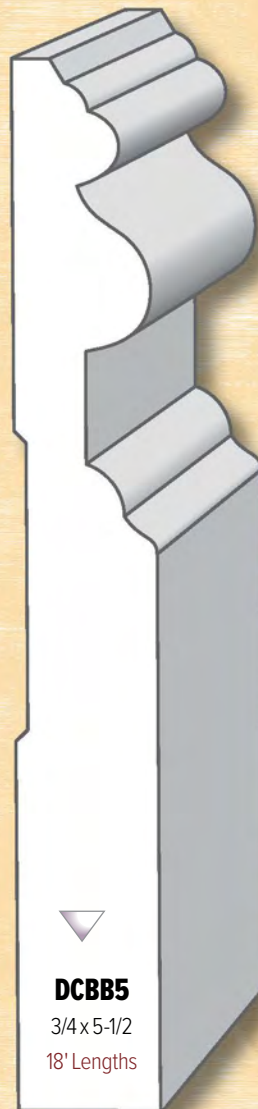

DCBB5

3/4 x 5-1/2

18' Lengths

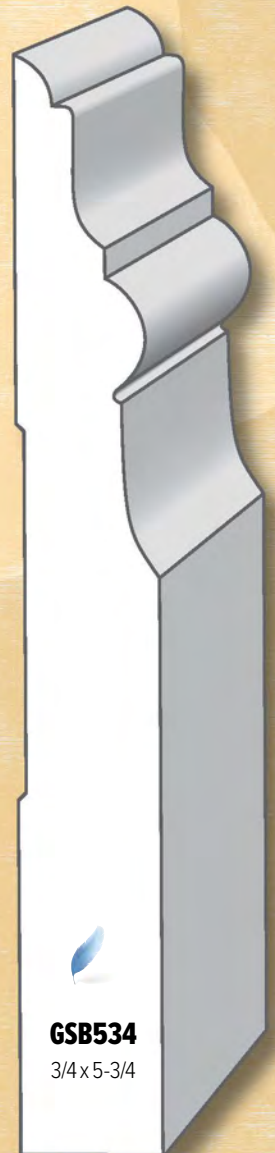

GSB534

3/4 x 5-3/4

BASES



DCB534



BB6



PLB612



MCB7

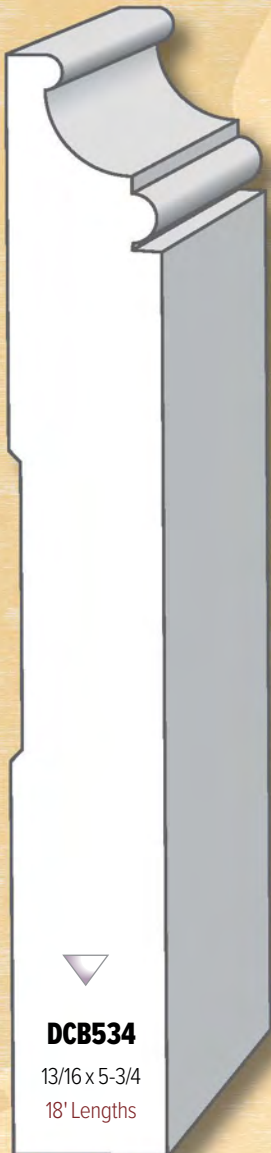

DCB534
13/16 x 5-3/4
18' Lengths

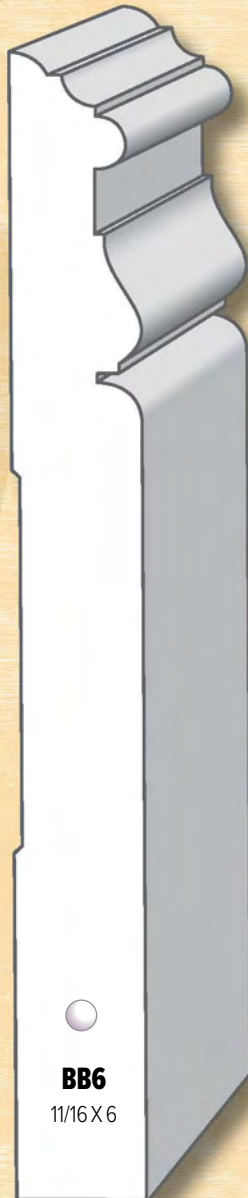

BB6
11/16 X 6



PLB612
3/4 x 6-1/2





MCB7
11/16 x 7

WWW.GARDENSTATELUMBER.COM

BASES

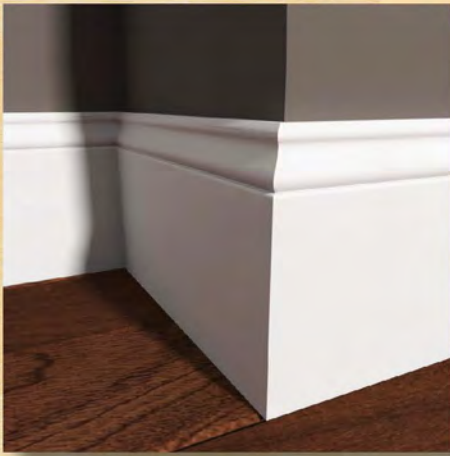

BB7



BB714



GSB725



BB7
1 1/16 x 7



BB714
9/16 x 7-1/4

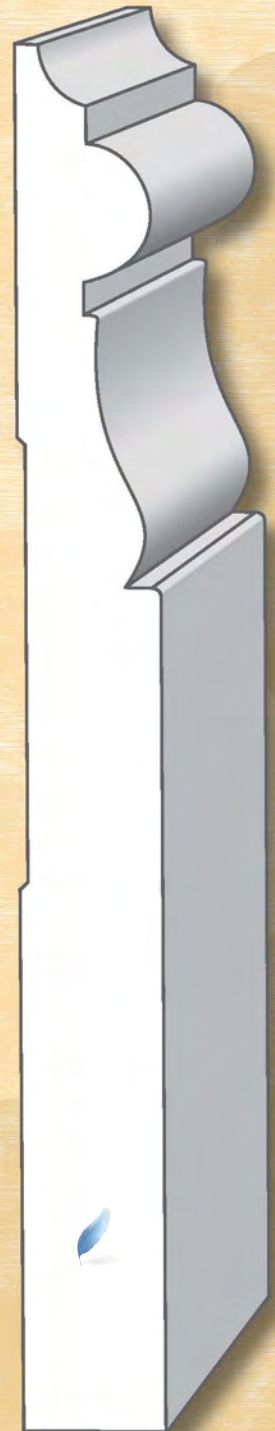

GSB725
3/4 x 7-1/4



BASES



MCB725
9/16 x 7-1/4

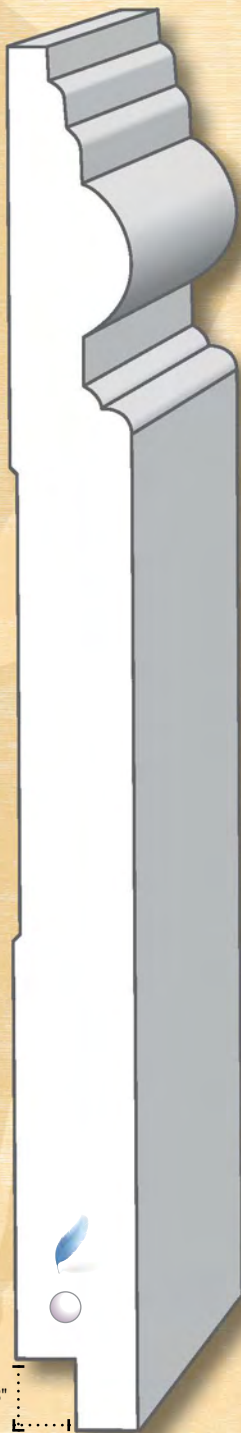

3/8"
5/16"

PLB714
5/8 x 7-1/4 (MDF)
BB738
11/16 x 7-3/8 (Primed)

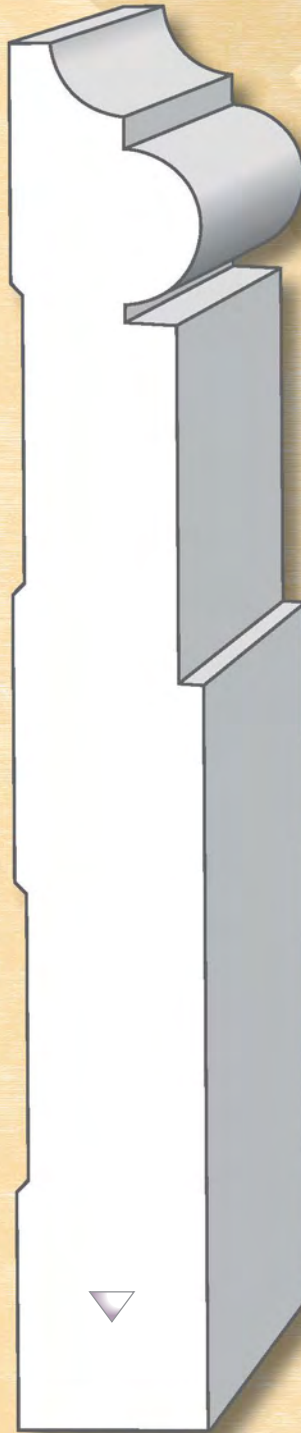

DCB714
1 x 7-1/4
18' Lengths

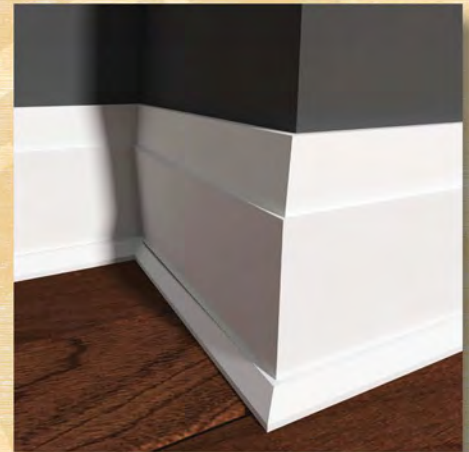

MCB725 Base with MCS1 Shoe



PLB714



DCB714

BASES



DCB775



PLB8



DCB8

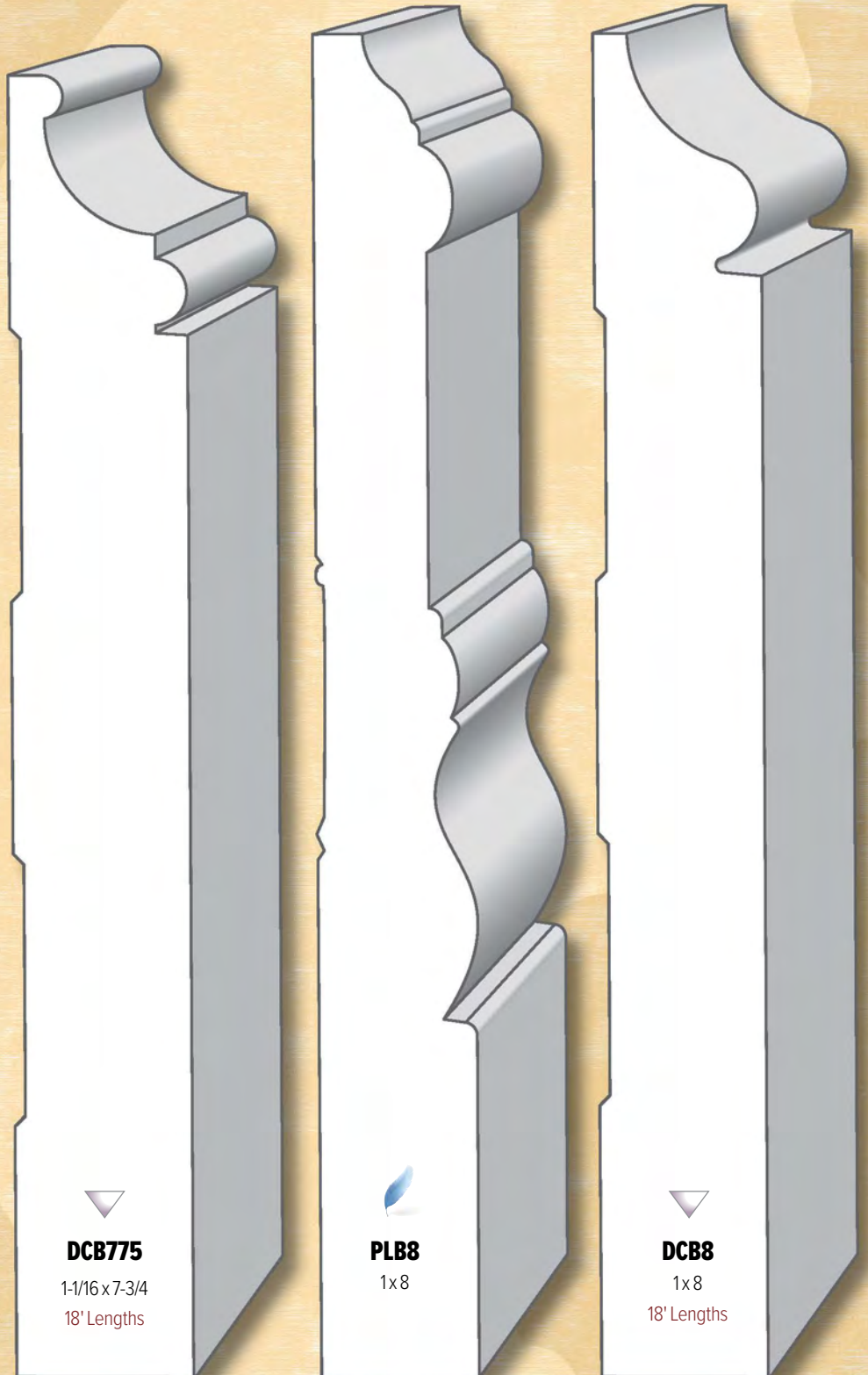

DCB775

1-1/16 x 7-3/4
18' Lengths



PLB8

1x8



DCB8

1x8
18' Lengths

BASES

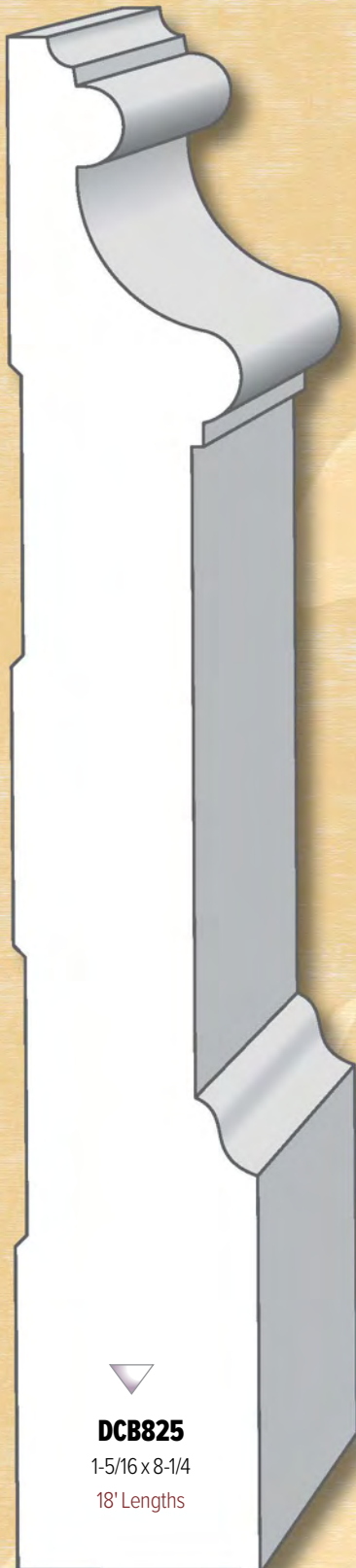

▼
DCB825
 1-5/16 x 8-1/4
 18' Lengths

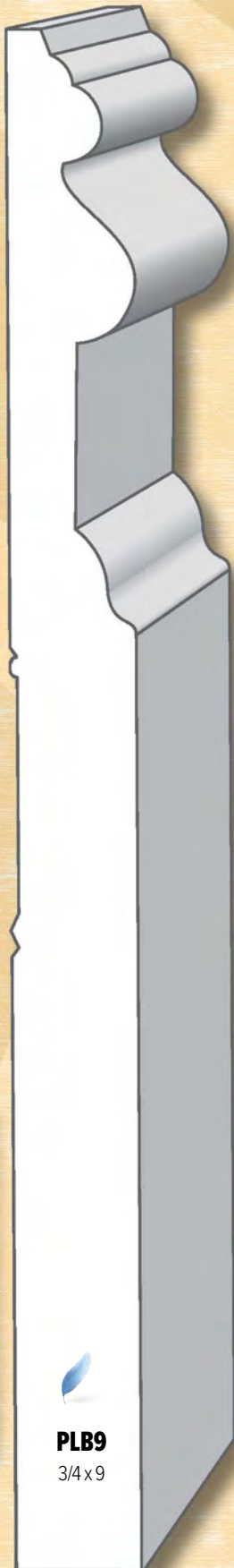

●
PLB9
 3/4 x 9

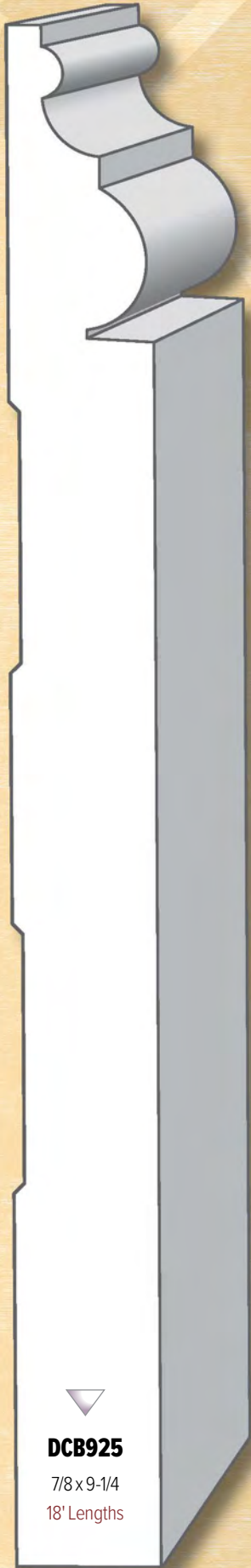

▼
DCB925
 7/8 x 9-1/4
 18' Lengths



DCB825



PLB9 Base with LWM903 Shoe



DCB925



BDB45 Casing & ES16 Back Band



BDBCAP Base Cap and 1 x 8

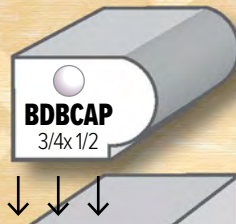

3/4" S4S



BDB55
5/8 x 5-1/2

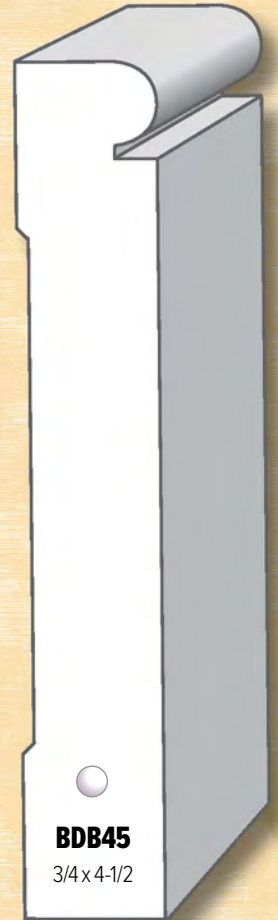

BDB45
3/4 x 4-1/2

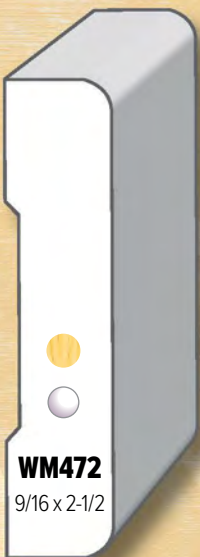

WM472
9/16 x 2-1/2

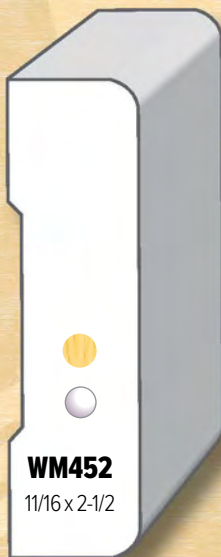

WM452
11/16 x 2-1/2



E2E432
9/16 x 3-1/2



LWM432
9/16 x 3-1/2



LWM412
11/16 x 3-1/2



CASINGS/BASES BEADED

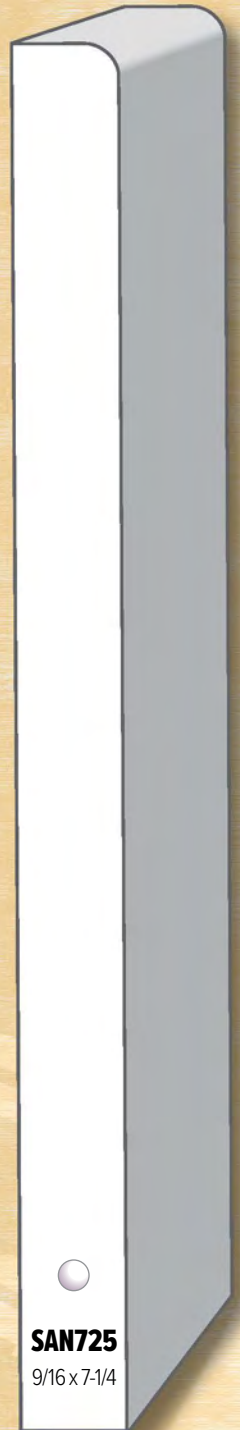
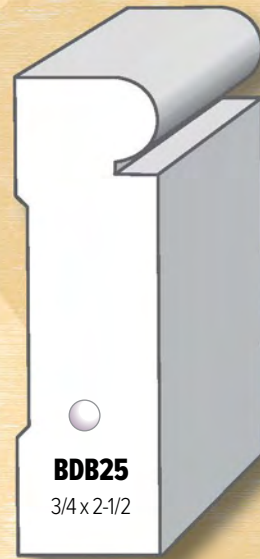
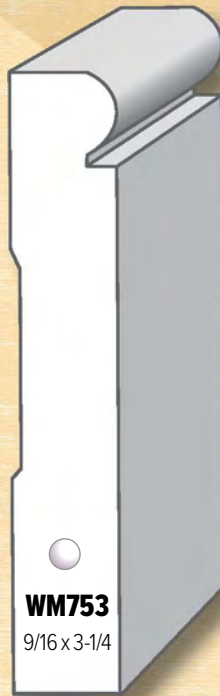
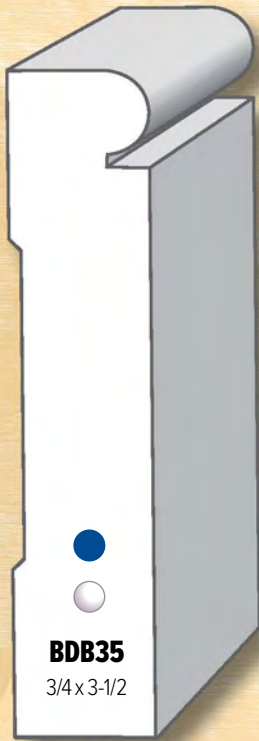
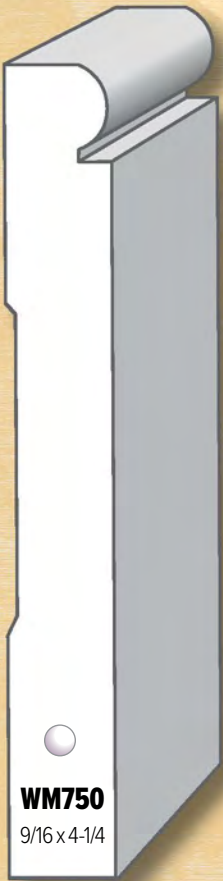

CASINGS/BASES SANITARY



WWW.GARDENSTATELUMBER.COM

CASINGS/BASES

METRO



MCAP1 Base Cap, 1x8, MCS1 Shoe

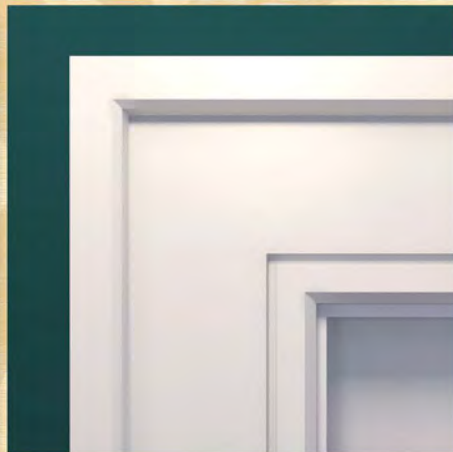

MCC412 Casing & MCBB2 Back Band

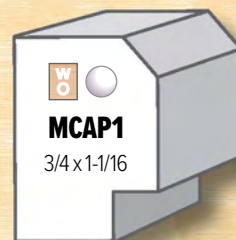

MCAP1
3/4 x 1-1/16



3/4" S4S

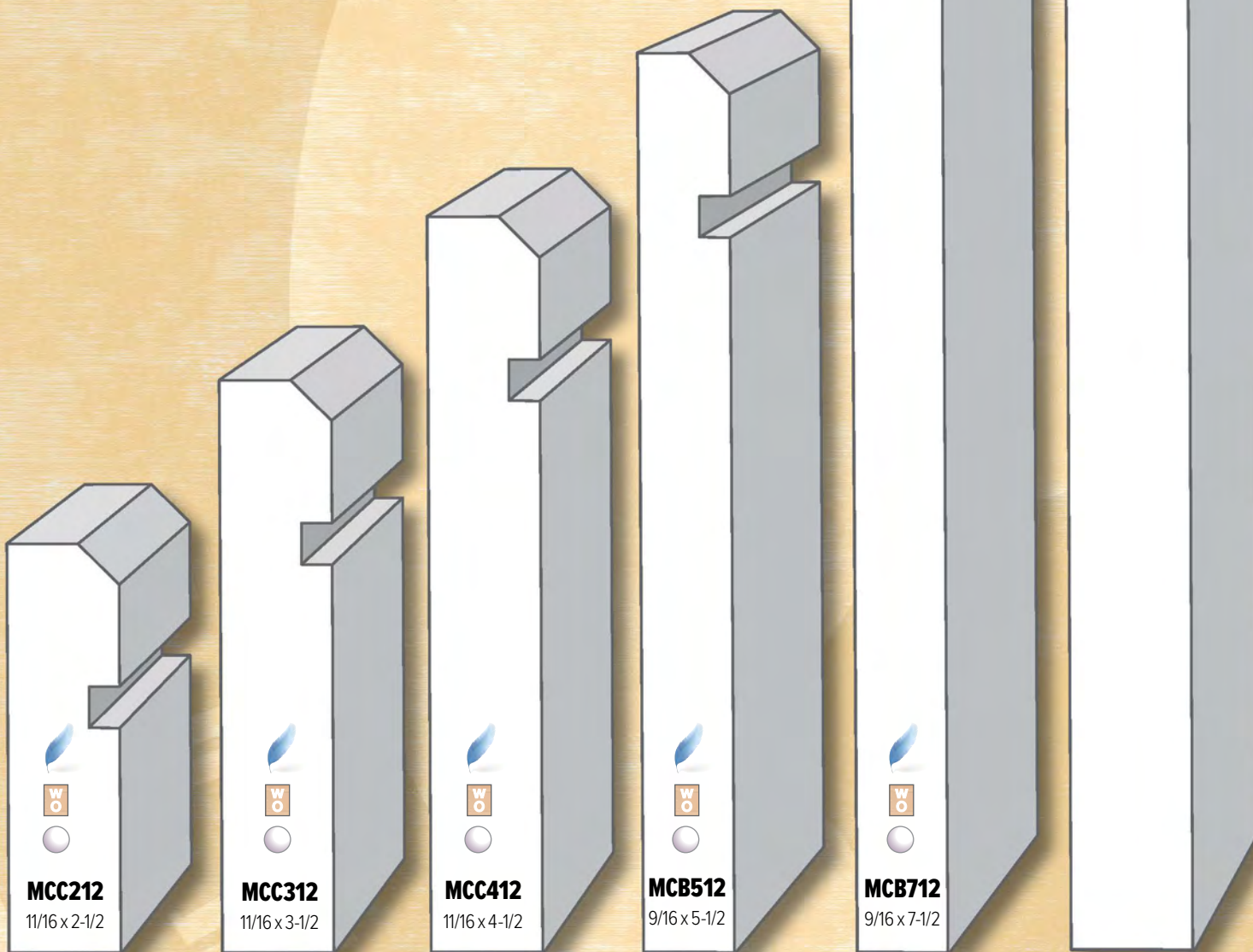

MCC212
11/16 x 2-1/2

MCC312
11/16 x 3-1/2

MCC412
11/16 x 4-1/2

MCC512
9/16 x 5-1/2

MCC712
9/16 x 7-1/2

MCB712





CASINGS

CASINGS



C8753
9/16 x 2-1/4

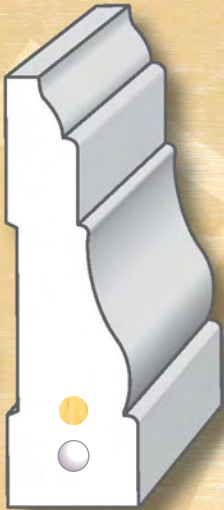

N8753
11/16 x 2-1/4
Square Edge
(WM366)

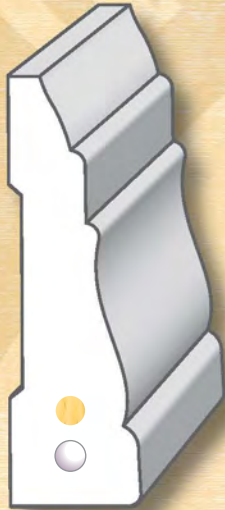

B8753
11/16 x 2-1/4
Eased Edge



WM376
11/16 x 2-1/4
Beaded

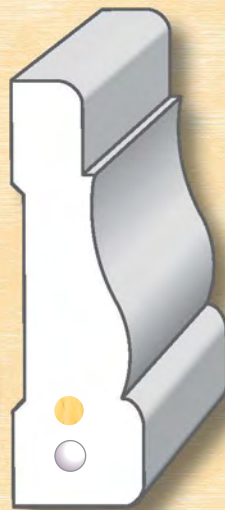

WM356
11/16 x 2-1/4
Fat Edge

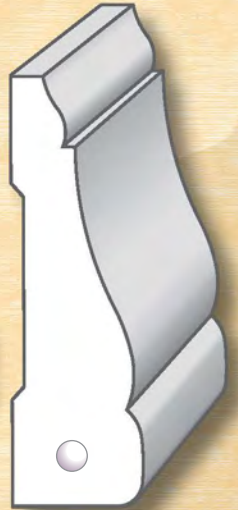

WM442
11/16 x 2-1/4



WM351
11/16 x 2-1/2
Fat Edge



8753
11/16 x 2-1/2
Eased Edge

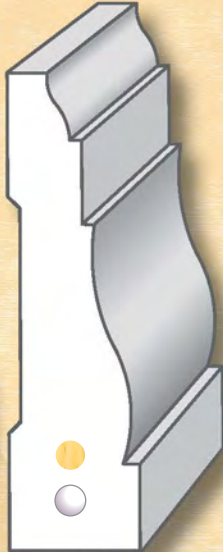

WM361
11/16 x 2-1/2
Square Edge

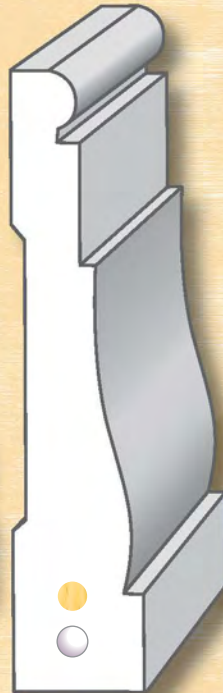

WM445
11/16 x 3-1/4
Beaded

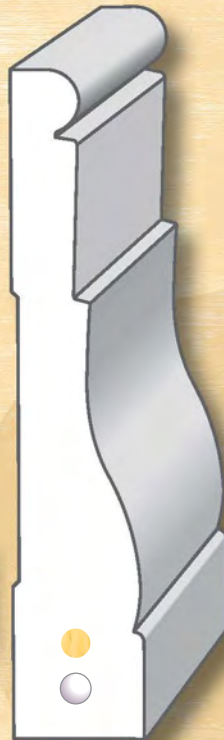

LWM445
11/16 x 3-1/2
Beaded

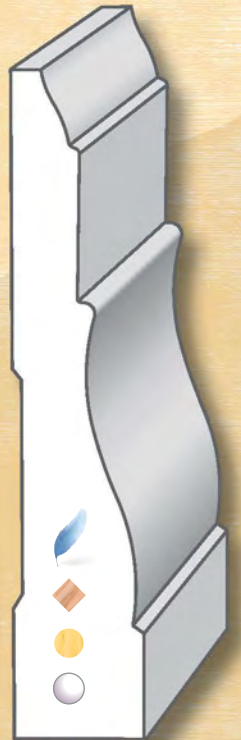

L8753
11/16 x 3-1/2
Square Edge



CASINGS

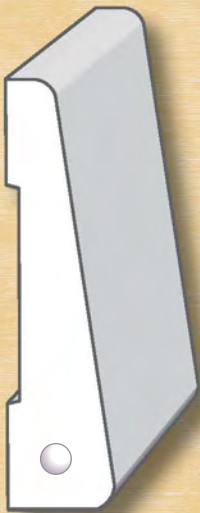

C103

9/16 x 2-1/4

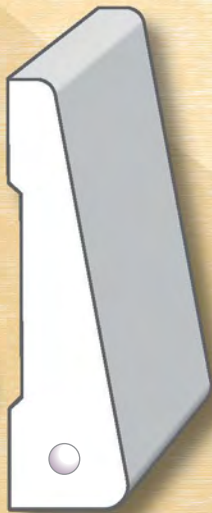

C105

5/8 x 2-1/4

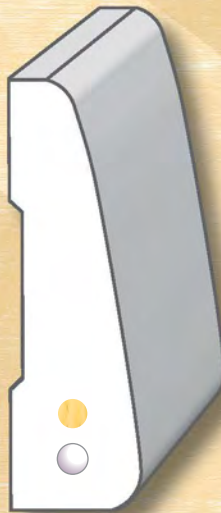

C106

11/16 x 2-1/4



WM327

11/16 x 2-1/4

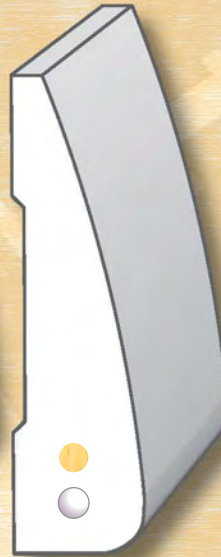

WM315

11/16 x 2-1/2



LWM321

11/16 x 2-1/2
Reverse Clam

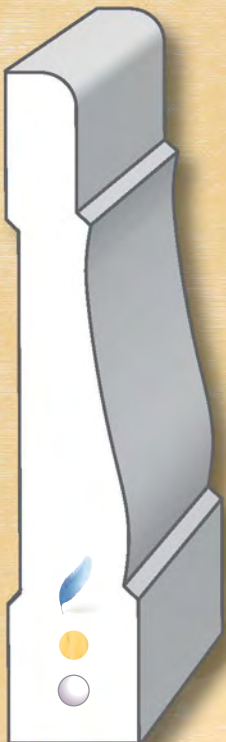

WM444

11/16 x 3-1/2
Fat Edge

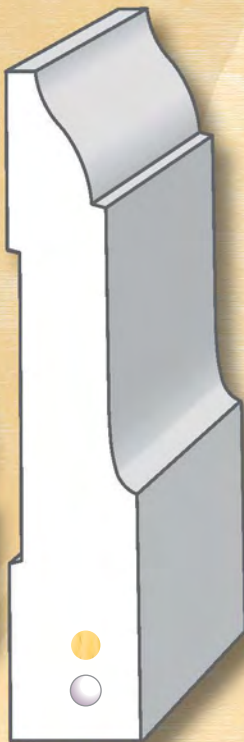

8711

11/16 x 3-1/2

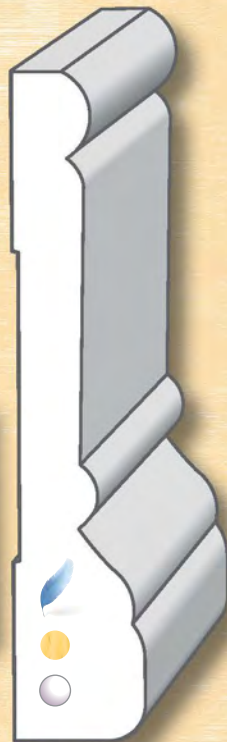

STF1

11/16 x 3-1/2

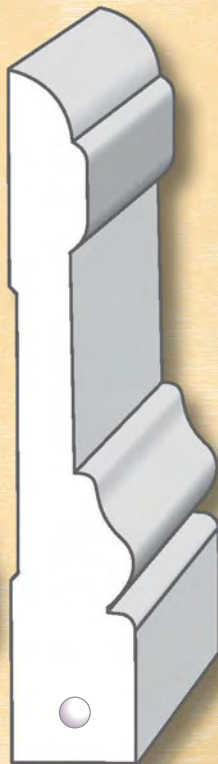

B8746

11/16 x 3-5/8

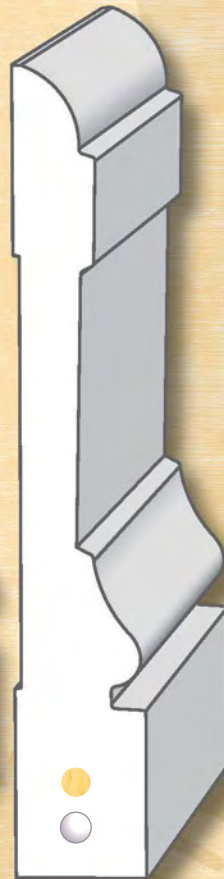

8746

11/16 x 4-1/4

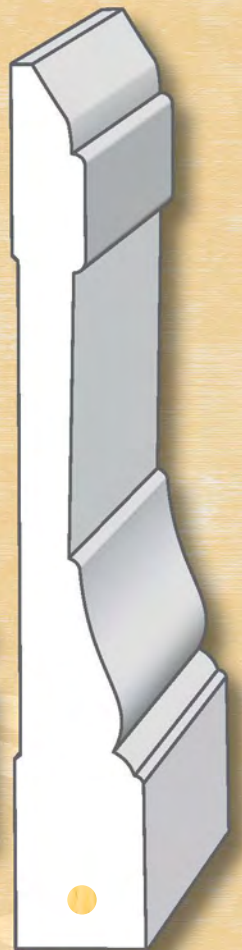

L8746

11/16 x 4-5/8

WWW.GARDENSTATELUMBER.COM

CASINGS



WC2

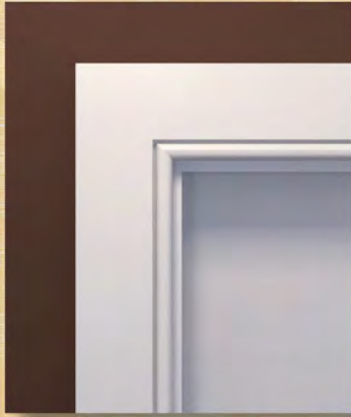

BDB25

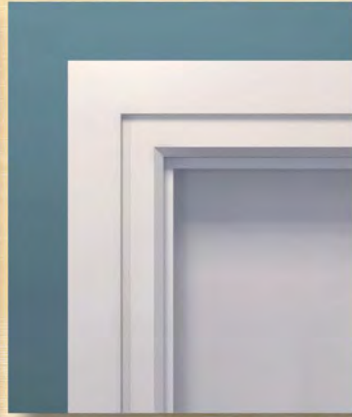

MCC212



LK3

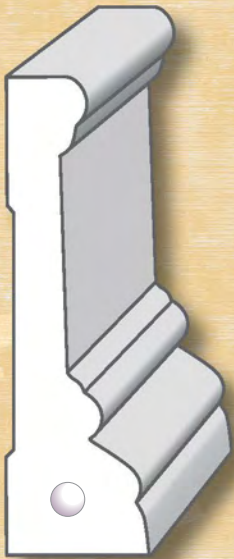

WC2

3/4x2-1/2

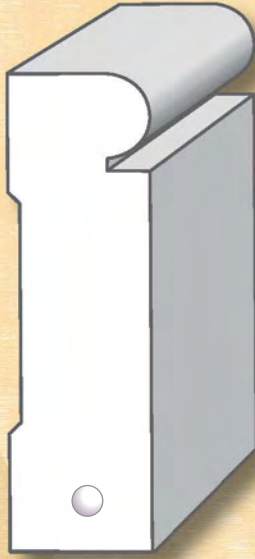

BDB25

3/4x2-1/2



MCC212

11/16x2-1/2

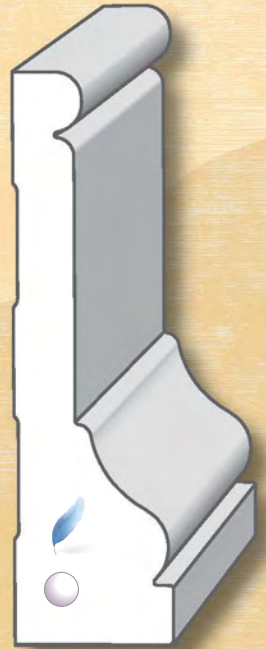

LK3

7/8x3

CASINGS



ES2



ES1

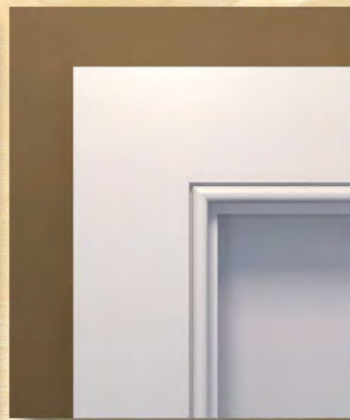

BDB35

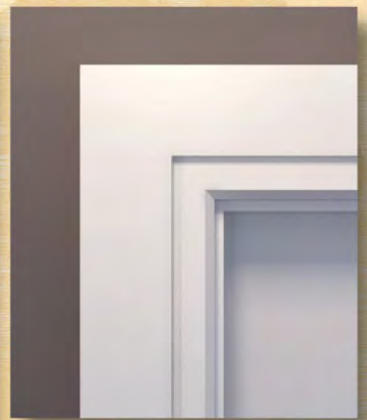

MCC312

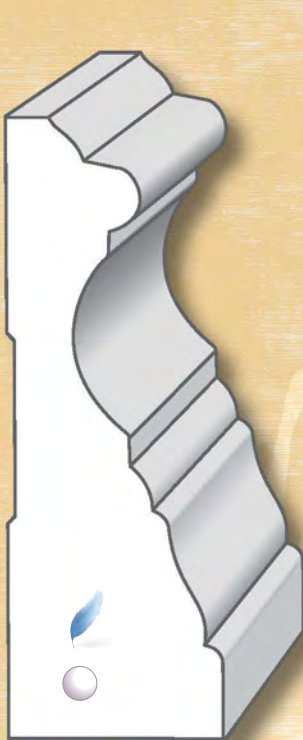

ES2

1-1/8 x 3-1/4
(MDF is 1" Thick)



ES1

3/4 x 3-1/2



BDB35

3/4 x 3-1/2

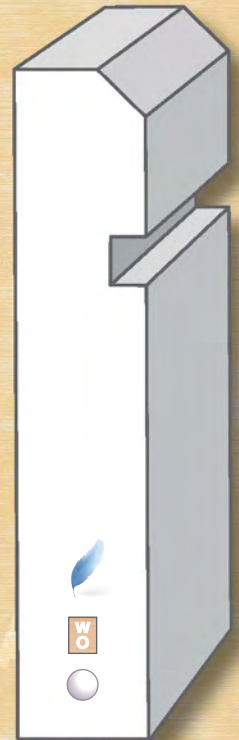

MCC312

1 1/16 x 3-1/2

CASINGS

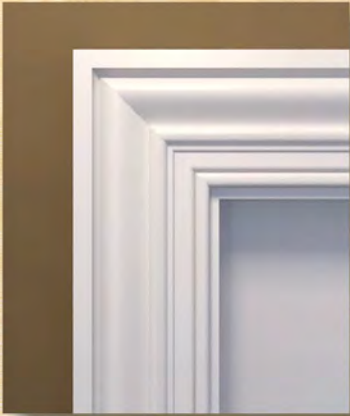

GS119



GS694

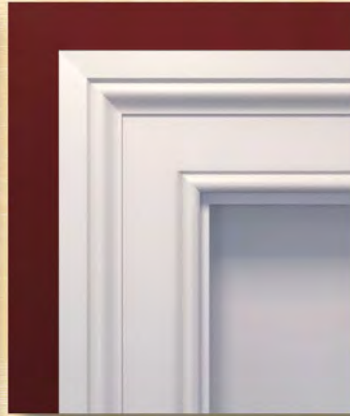

WM97



WC1

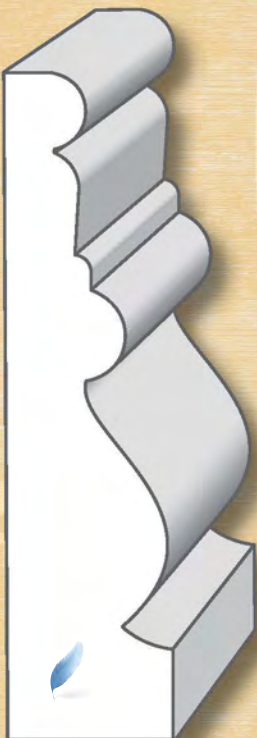

GS119

1x3-1/2

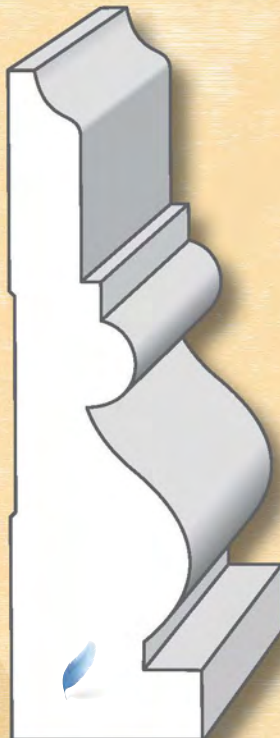

GS694

1x3-1/2

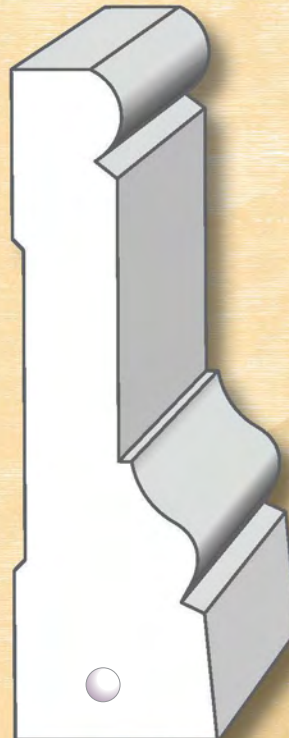

WM97

1-1/16 X 3-1/2
Adams Casing

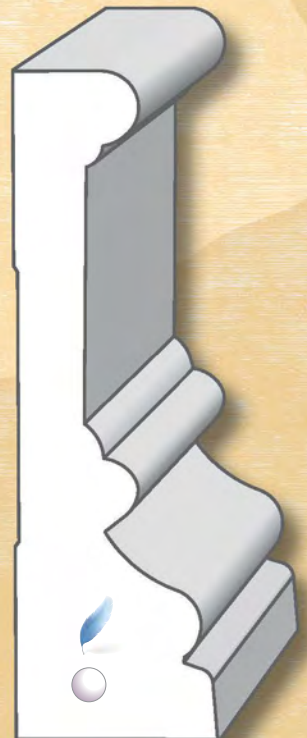

WC1

1-1/16 x 3-1/2
(Windsor NY)



CASINGS

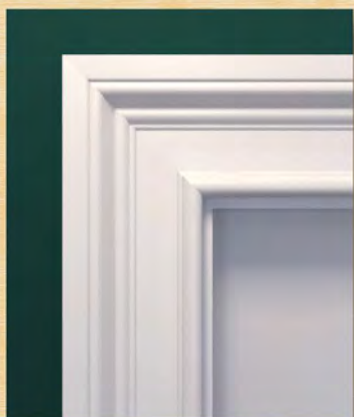

WC1CT

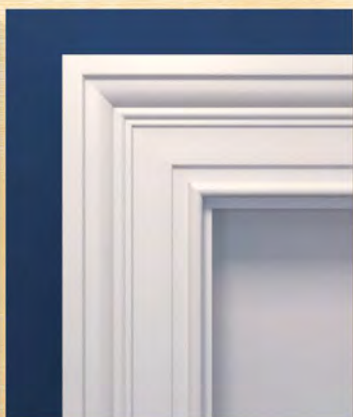

CGM31



MCC334



MCC375

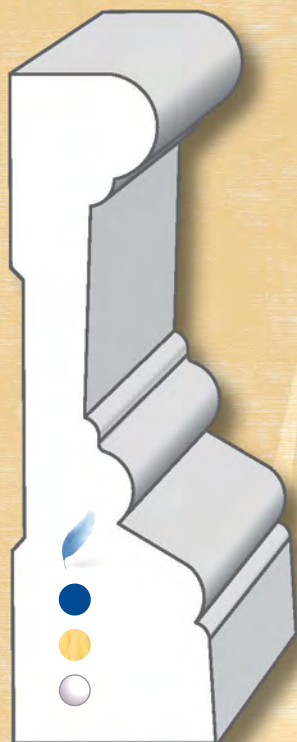

WC1CT

1-1/16" x 3-1/2"
(Windsor CT)

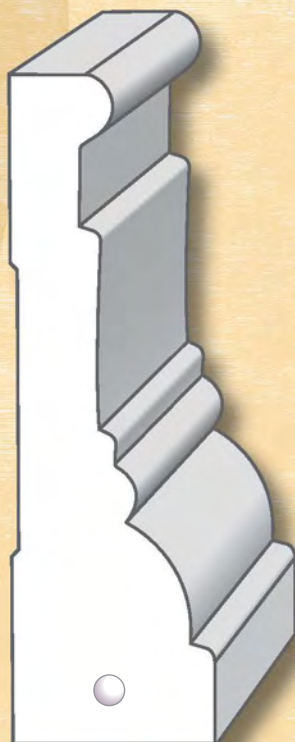

CGM31

1-1/16" x 3-1/2"

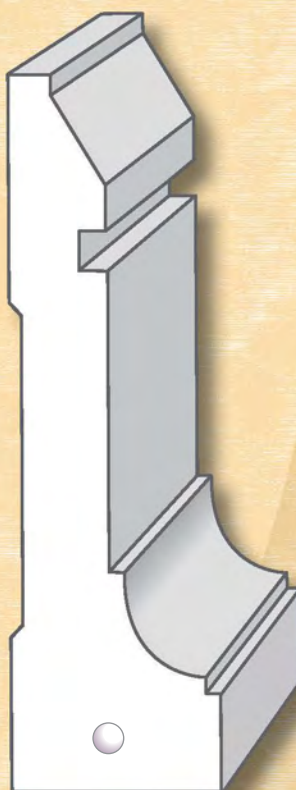

MCC334

1-1/8" x 3-3/4"

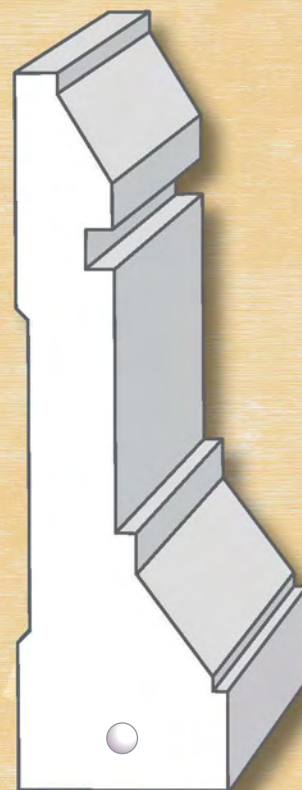

MCC375

1-1/8" x 3-3/4"

CASINGS



PM2200



PL378

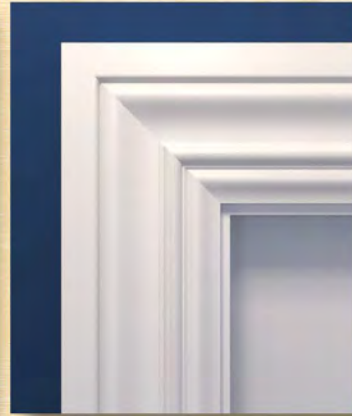

GS400



LK4

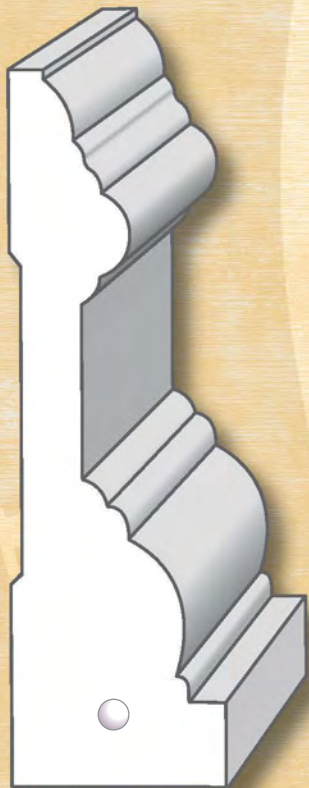

PM2200
1-1/8 x 3-3/4

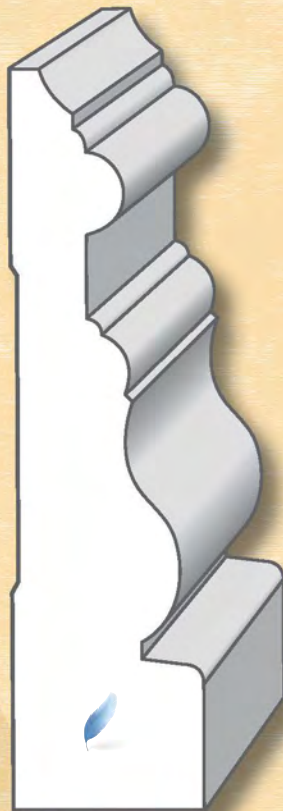

PL378
1 x 3-7/8



GS400
1 x 4

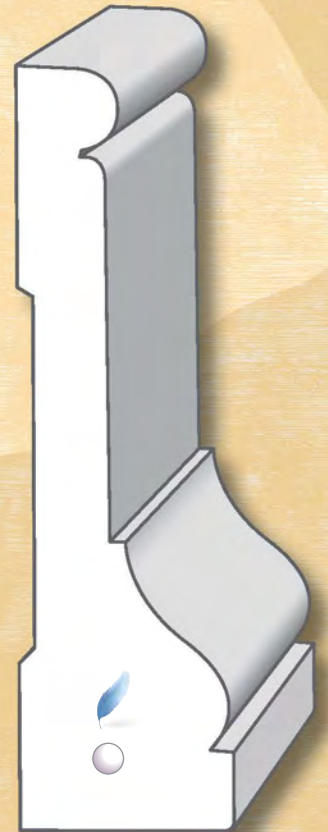

LK4
1-1/8 x 4



CASINGS

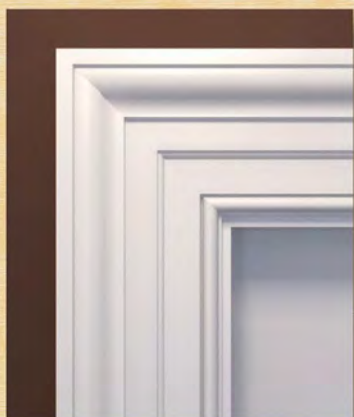

DC400

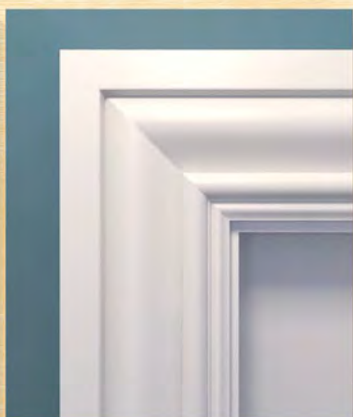

ES4



GS425

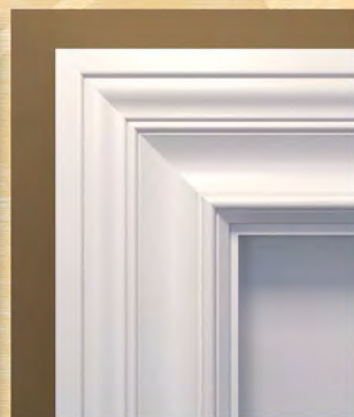

GS441

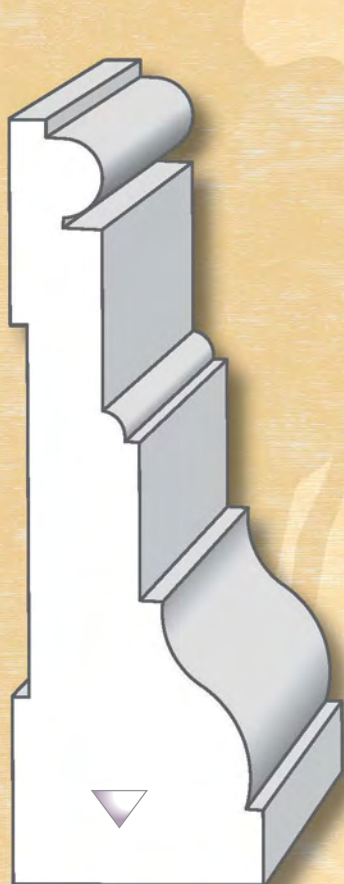

DC400

1-5/16 x 4
18' Lengths

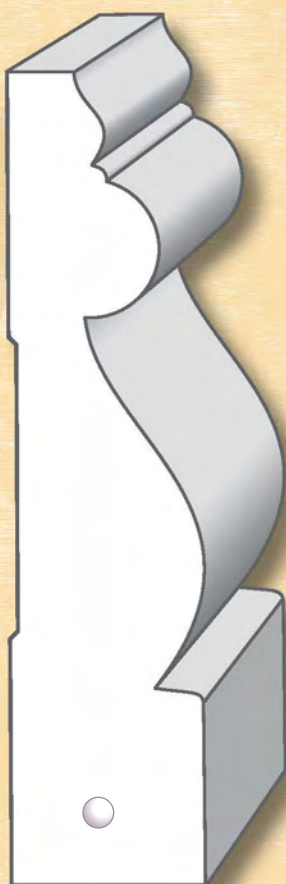

ES4

1 x 4-1/4

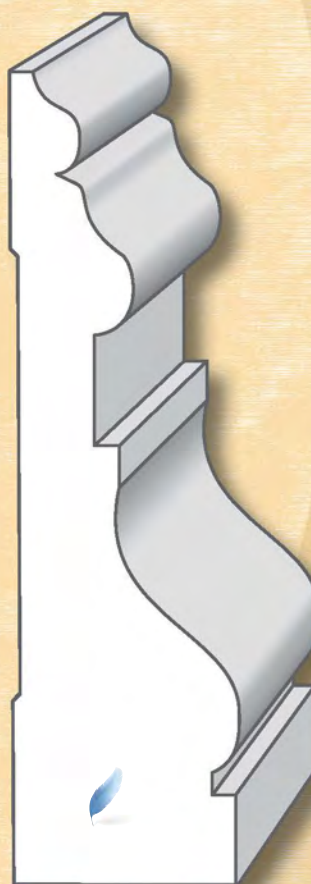

GS425

1-3/16 x 4-1/4

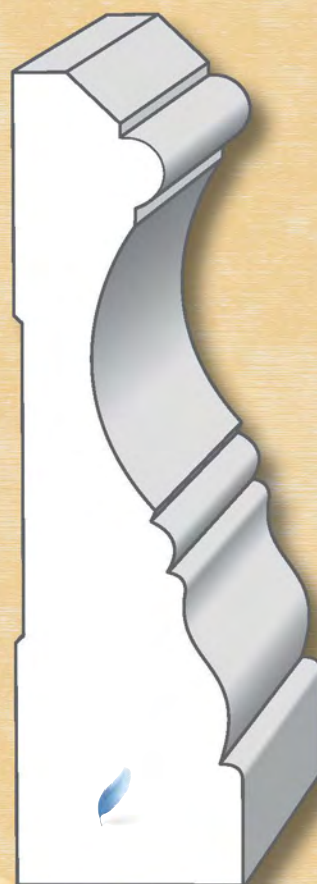

GS441

1-3/16 x 4-1/4

CASINGS

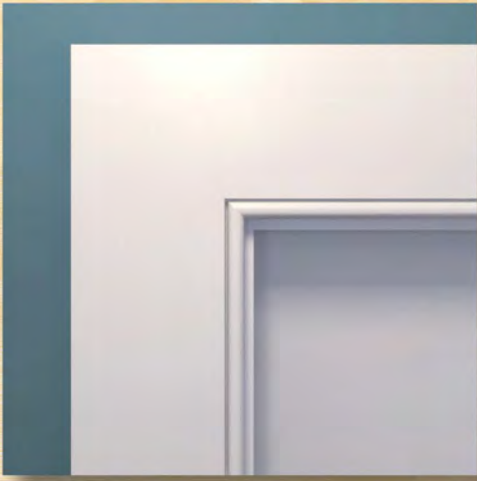

BDB45



MCC412



ES12

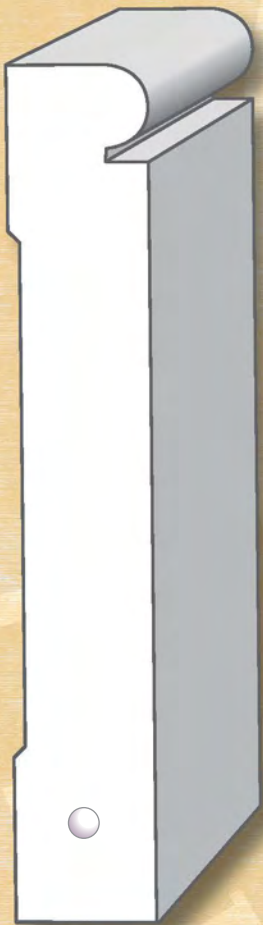

BDB45
3/4 x 4-1/2



MCC412
1 1/16 x 4-1/2



ES12
1 1/16 x 4-1/2



CASINGS



JC412



ES3



GS419

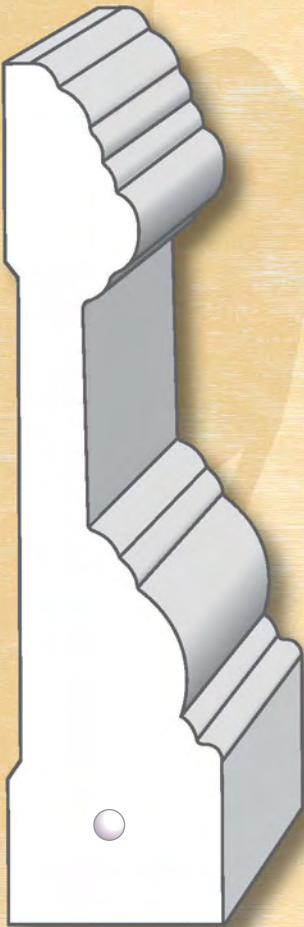

JC412

1-1/8 x 4-1/2

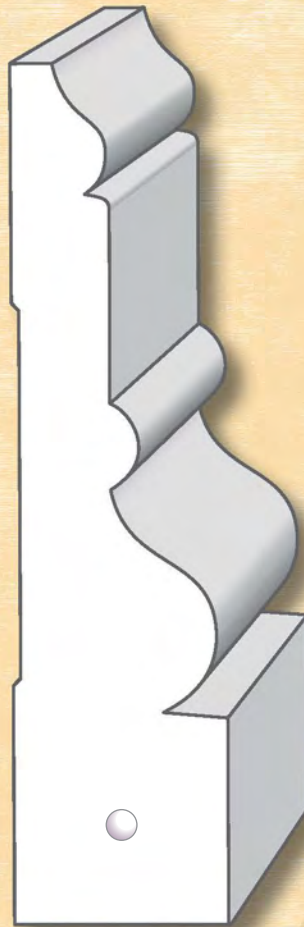

ES3

1-1/8 x 4-1/2

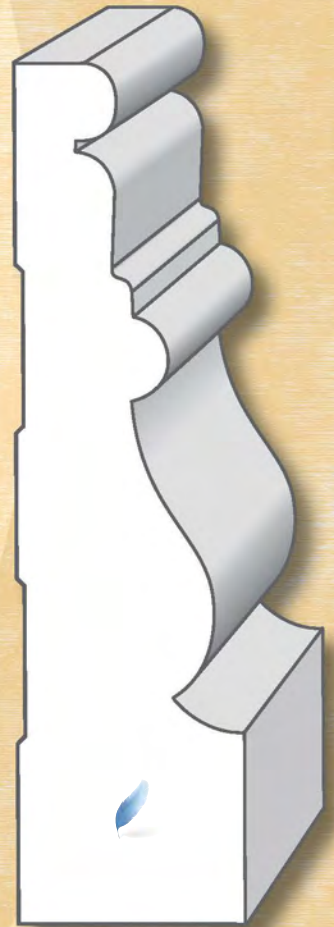

GS419

1-3/16 x 4-1/2

CASINGS



DC412



DC450



PL458

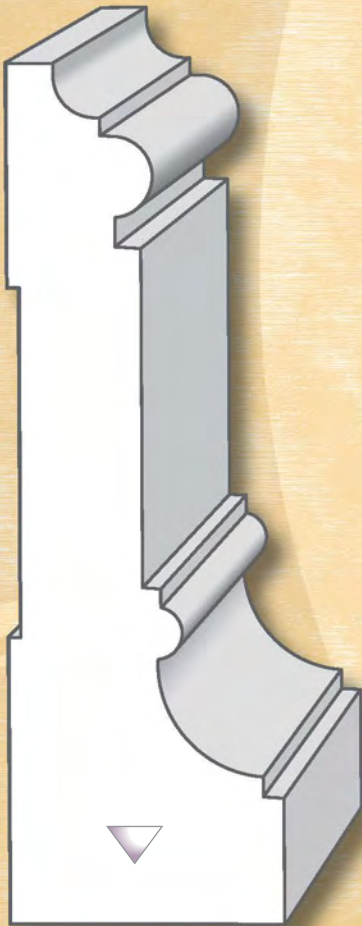

DC412

1-7/16 x 4-1/2
18' Lengths

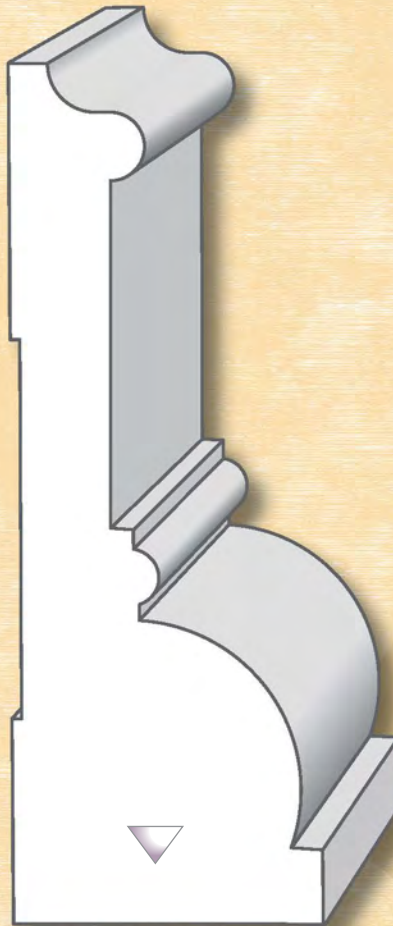

DC450

1-5/8 x 4-1/2
18' Lengths

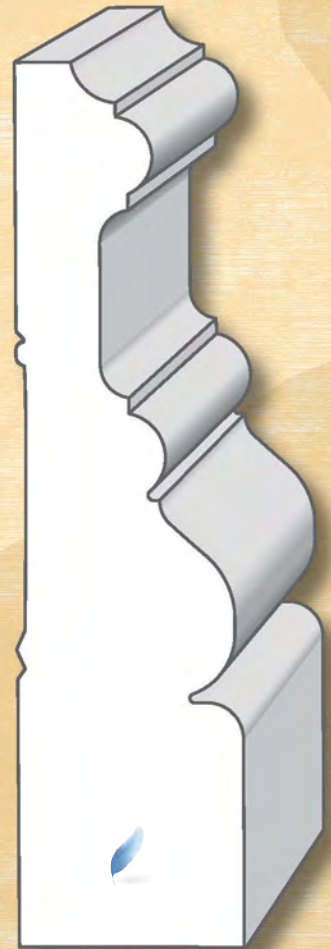

PL458

1-3/16 x 4-5/8

CASINGS



GS434



MCC434



MCC475

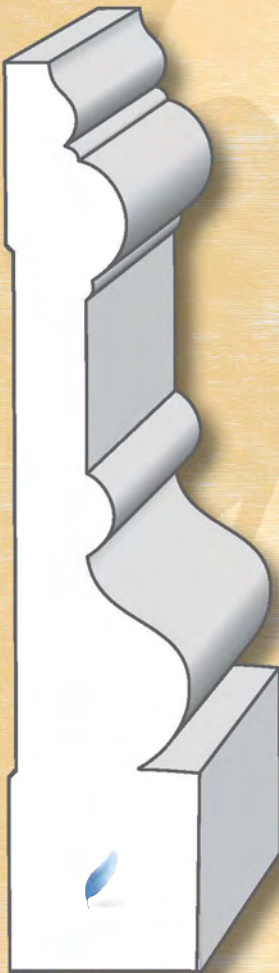

GS434
1x4-3/4

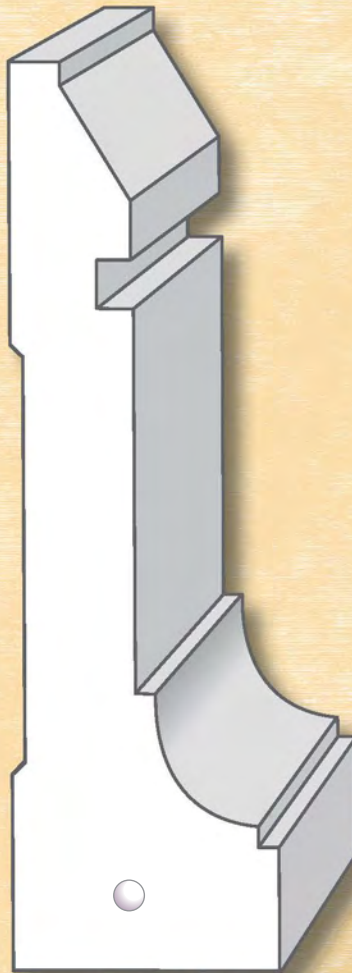

MCC434
1-3/8" x 4-3/4"

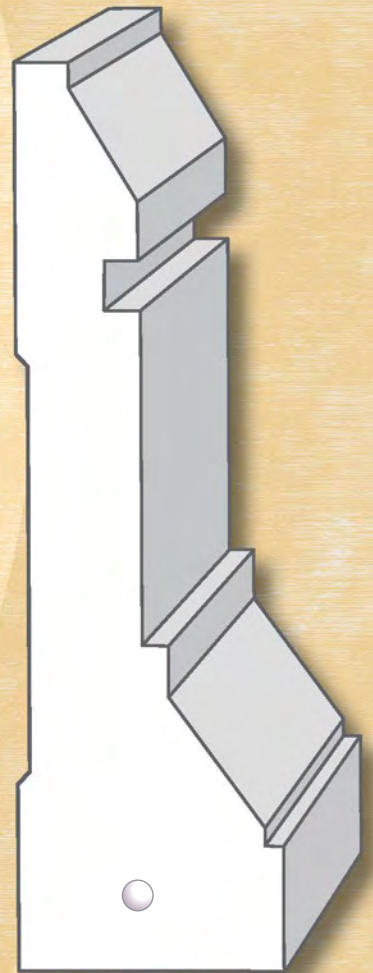

MCC475
1-3/8" x 4-3/4"

CASINGS



DCWC5



DCLK5



DC499

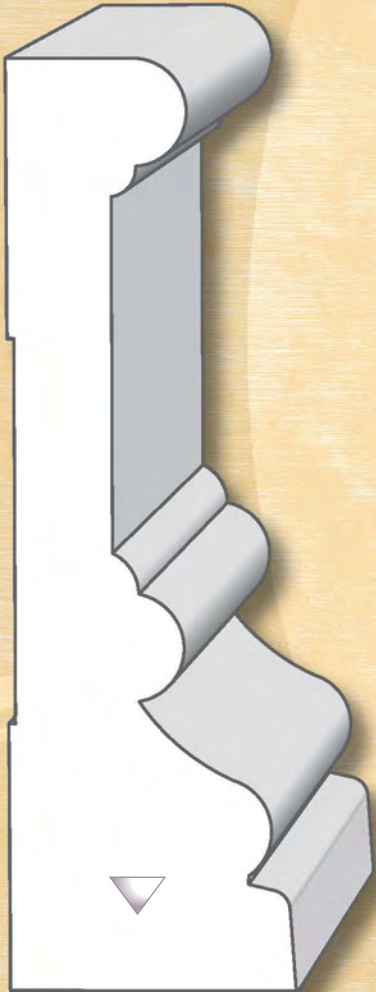

DCWC5

1-1/2 x 4-7/8
18' Lengths

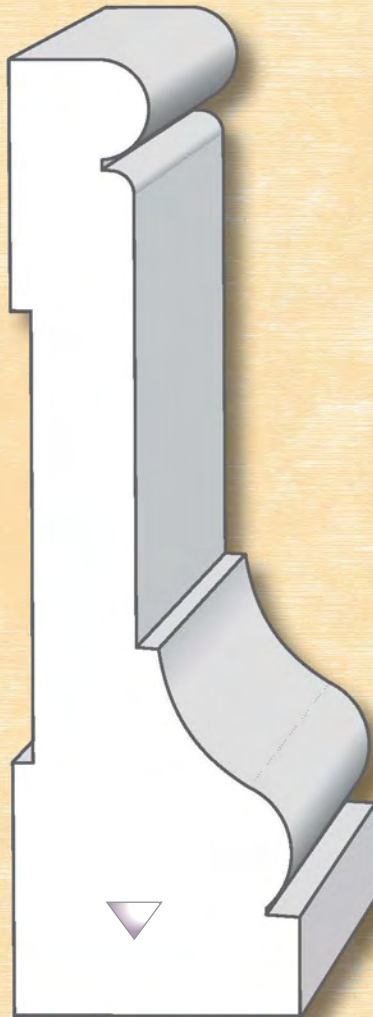

DCLK5

1-1/2 x 5
18' Lengths

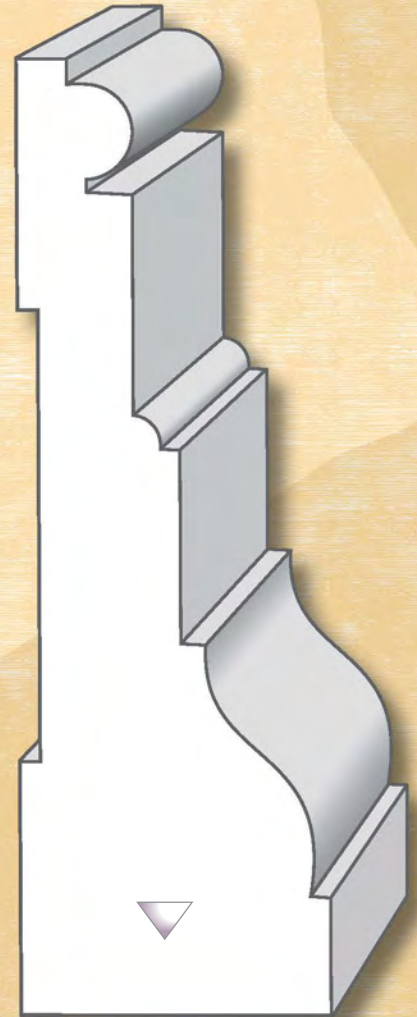

DC499

1-5/8 x 5
18' Lengths



CASINGS



PL514



DCAS5



DC512

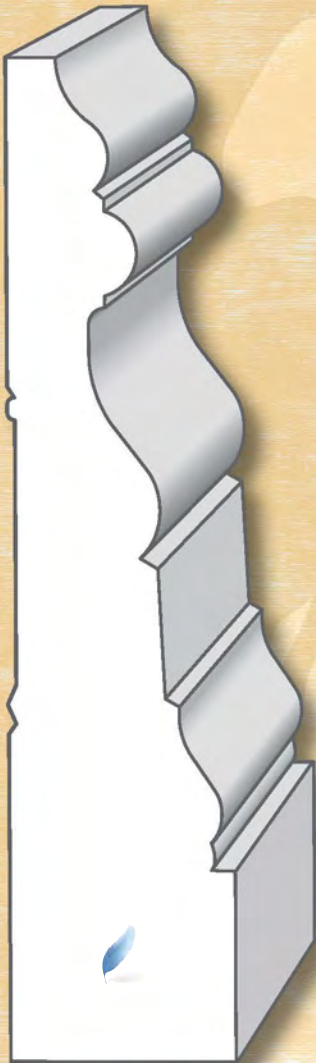

PL514

1-3/16 x 5-1/4

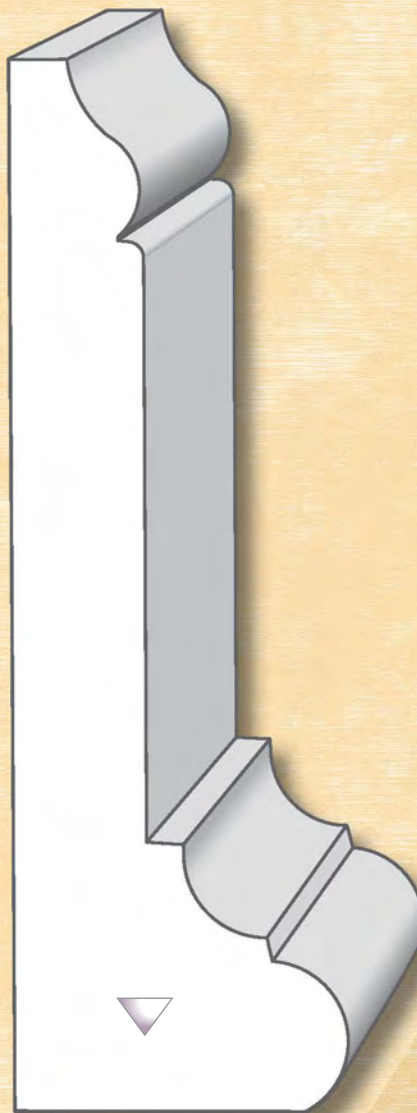

DCAS5

1-3/4 x 5-1/2

18' Lengths

* Also used as Chair Rail

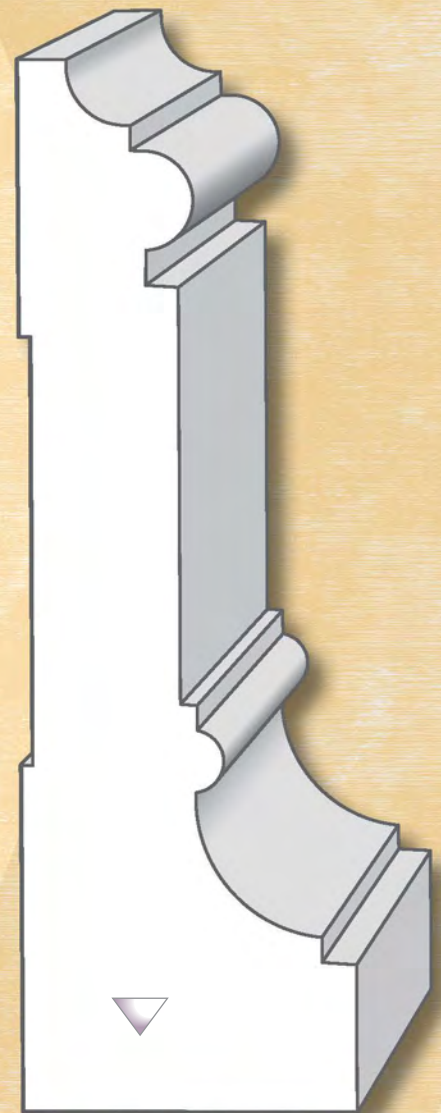

DC512

1-3/4 x 5-1/2

18' Lengths

CASINGS



DC550



MCC534



MCC575

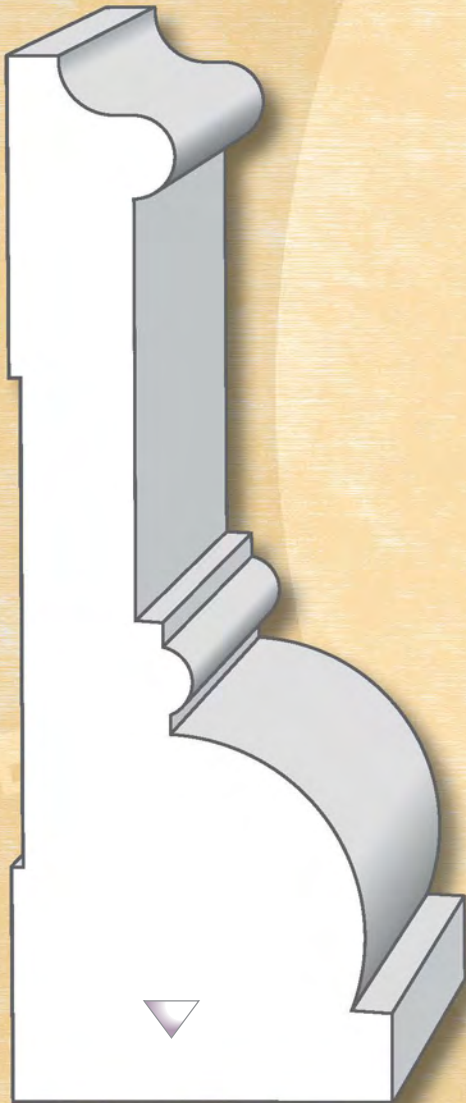

DC550

2x5-1/2 18' Lengths

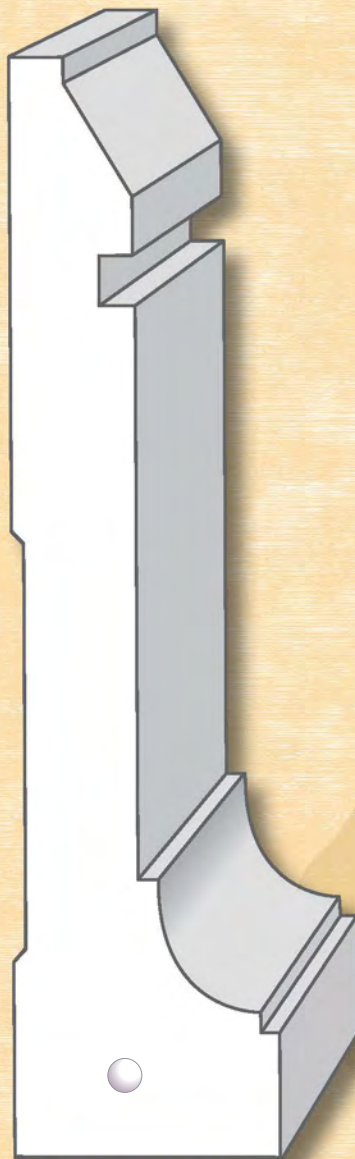

MCC534

1-3/8x5-3/4

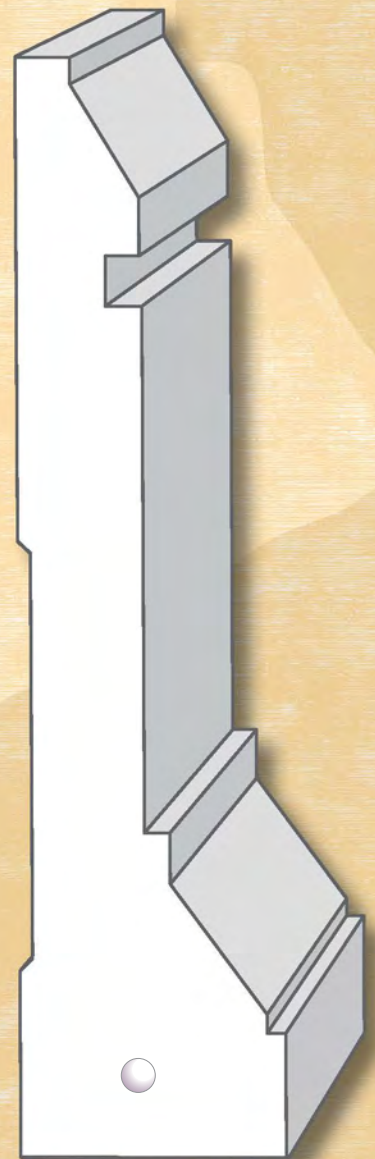

MCC575

1-3/8x5-3/4

FLUTED/REEDED CASINGS



RC214
5/8 x 2-1/4



FR214
11/16 x 2-1/4

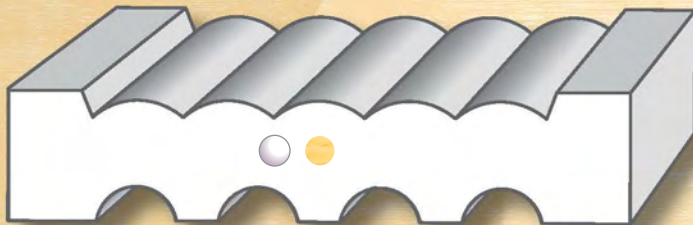

FR314
11/16 x 3-1/4



SC234 Solid Crown, 8577 Nose & Cove,
5/4" x 6" & FR314 Fluted/Reeded Casing

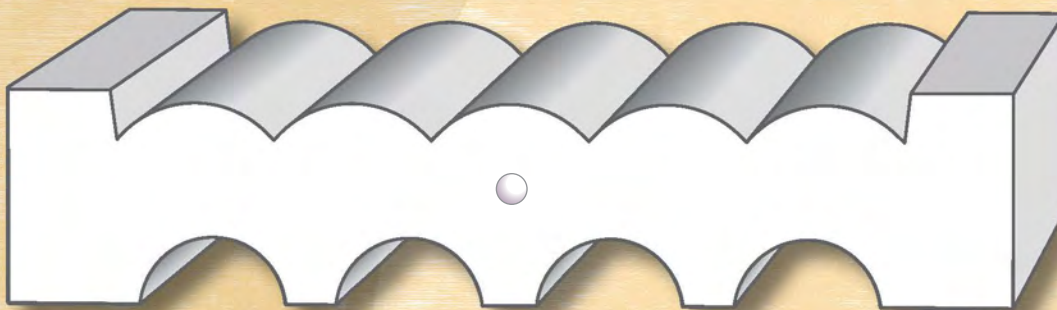

P514 *Pilaster*
1-1/8 x 5-1/4

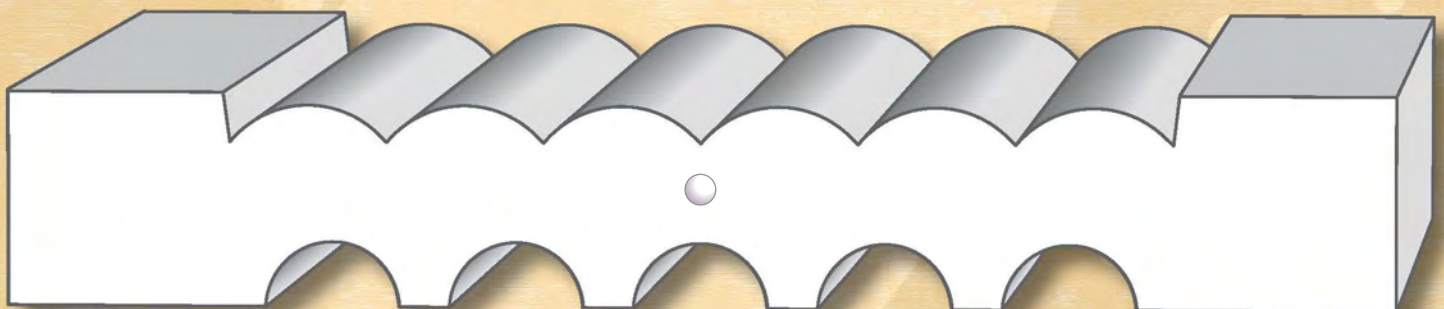

P714 *Pilaster*
1-1/8 x 7-1/4

BACK BANDS

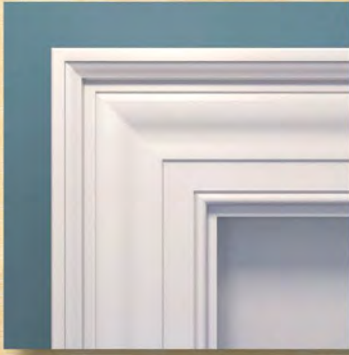

WM281 with LWM445 Casing



8313 with L8753 Casing



MCB1 with MCC312 Casing



138BBPVC with 1x4 S4S

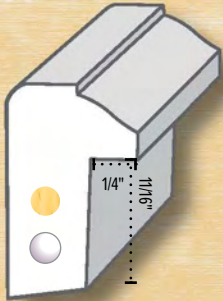

WM281

11/16 x 1-1/8

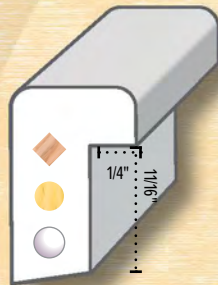

8313

11/16 X 1-1/8

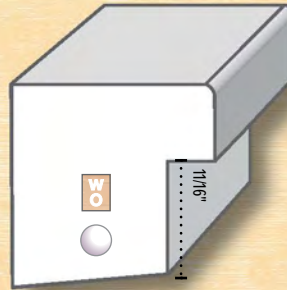

MCBB1

1-1/16 x 1-1/16

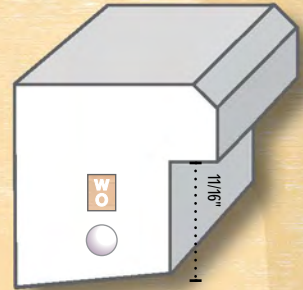

MCBB2

1-1/16 x 1-1/16

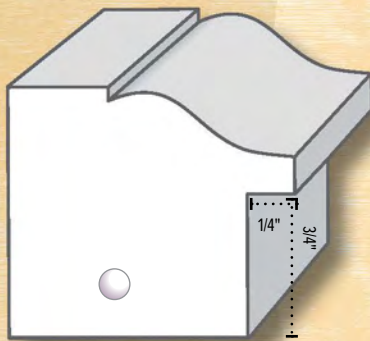

ES16

1-1/2 x 1-3/8

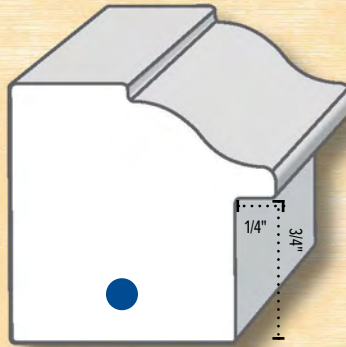

138BB

1-1/2 x 1-3/8

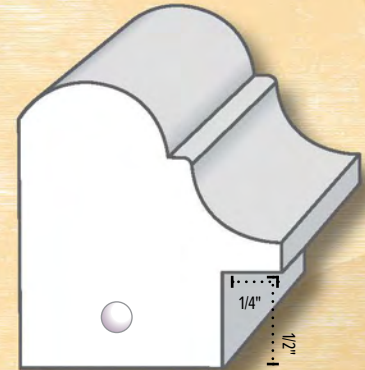

BBCAP12

1-3/8 x 1-1/2

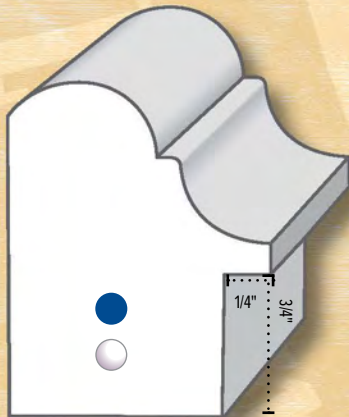

ECBCAP

1-3/8 x 1-3/4

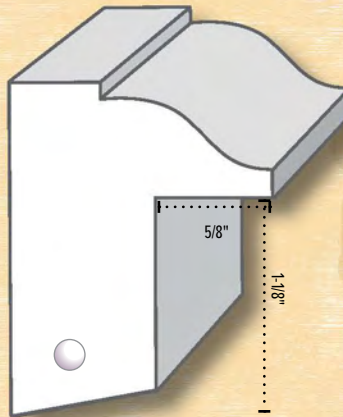

ES13

1-3/8 x 1-3/4

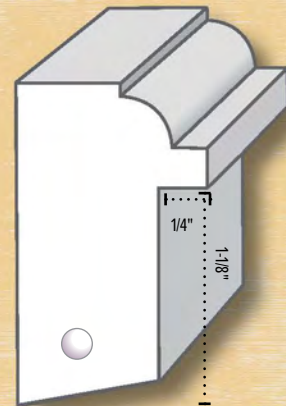

ES14

1 x 1-11/16



PLINTH BLOCKS



All plinths are available in solid poplar 8' in length – plinths should be cut to a height approximately 1/8" to 1/4" taller than the base moulding being used

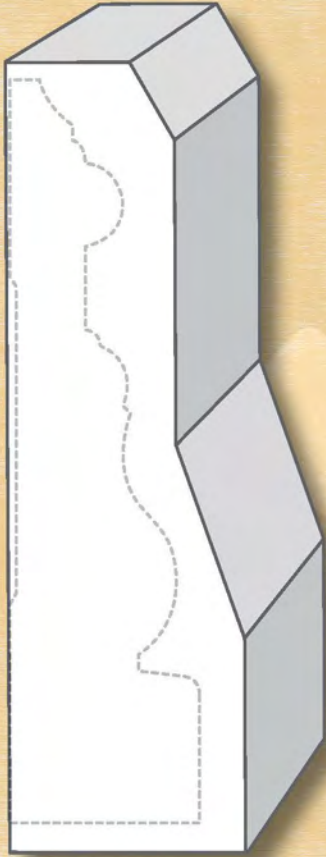

PB418 1-1/4 x 4-1/8
Will accommodate all casings
3-1/4" to 3-7/8" in width

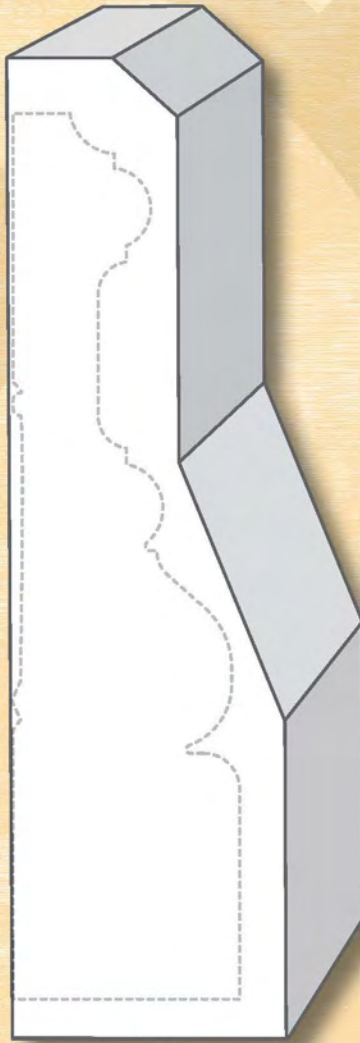

PB518 1-7/16 x 5-1/8
Will accommodate all casings and most casing/
backband combinations 4" to 4-7/8" in width

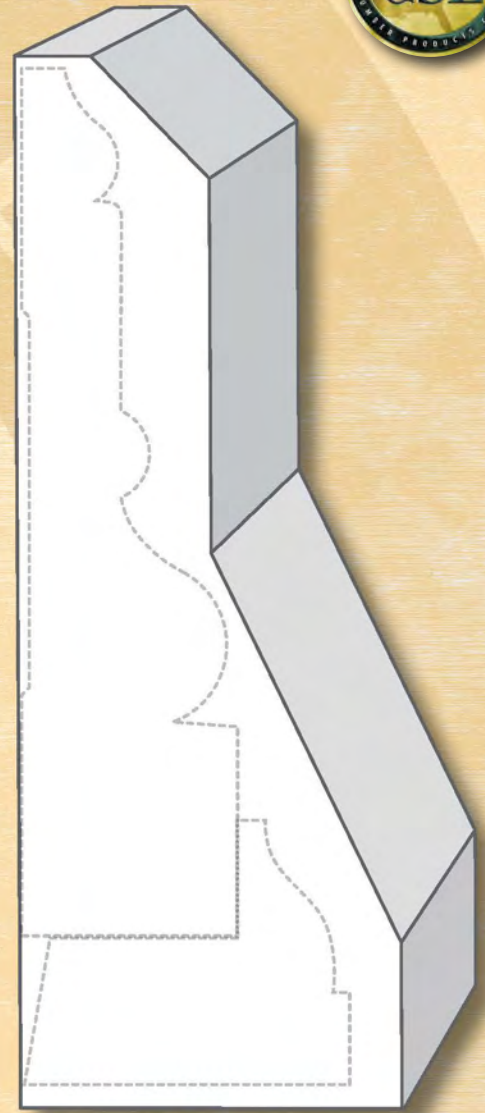

PB550 2 x 5-1/2
Will accommodate all casings and most casing/
backband combinations 4-7/8" to 5-1/4"



*PB418 Plinth Block with
PL378MDF Casing*



*PB518 Plinth Block with
PL458MDF Casing*



*PB550 Plinth Block with
ES3 Casing and ES13 Back Band*

WWW.GARDENSTATELUMBER.COM

ARCHITECTURAL ACCENTS

ROSETTES

Wellington



- WEL212** (1" x 2-1/2") ○
- WEL234** (1" x 2-3/4") ○ ◆
- WEL312** (1" x 3-1/2") ○ ◆
- WEL334** (1" x 3-3/4") ○ ◆
- WEL412** (1" x 4-1/2") ○ ◆
- WEL500** (1-5/16" x 5") ▽
- WEL834** (1-1/4" x 3-3/4") ○
- WEL414** (1-1/4" x 4-1/4") ○
- WEL512** (1-1/4" x 5-1/2") ○

Lexington

(daisy)



- LEX312** (7/8" x 3-1/2") ○ ◆
- LEX412** (7/8" x 4-1/2") ○

KEYSTONES



- KEY312** (1" x 3-1/2") ○
- KEY412** (1" x 4-1/2") ○
- KEY512** (1" x 5-1/2") ○

Cambridge



- CAM312** (1" x 3-1/2") ○ ◆
- CAM334** (1" x 3-3/4") ○ ◆
- CAM834** (1-1/4" x 3-3/4") ○
- CAM434** (1" x 4-3/4") ○
- CAM512** (1-1/4" x 5-1/2") ○
- CAM712** (1-1/4" x 7-1/2") ○

ARCH ROSETTES



- WA234** (1" x 2-3/4" x 4-1/2") ○
- WA334** (1" x 3-3/4" x 6") ○
- WA834** (1-5/16" x 3-3/4" x 7") ▽

PLINTH BLOCKS

Pilaster



- PPB512** (1-1/8" x 5-1/2" x 8") ○
- PPB712** (1-1/8" x 7-1/2" x 8") ○

Bridgeford



- BRI234** (1" x 2-3/4" x 6") ○ ◆
- BRI312** (1" x 3-1/2" x 6") ○ ◆
- BRI334** (1" x 3-3/4" x 6") ○
- BRI833** (1-1/8" x 4-1/2" x 8") ○
- BRI434** (1" x 4-3/4" x 6") ○

Wellington



- WPB334** (1" x 3-3/4" x 6") ○

Rosettes and plinth blocks can be special ordered in any size, shape or species (minimum quantities apply)





CHAIR RAILS

CHAIR RAILS

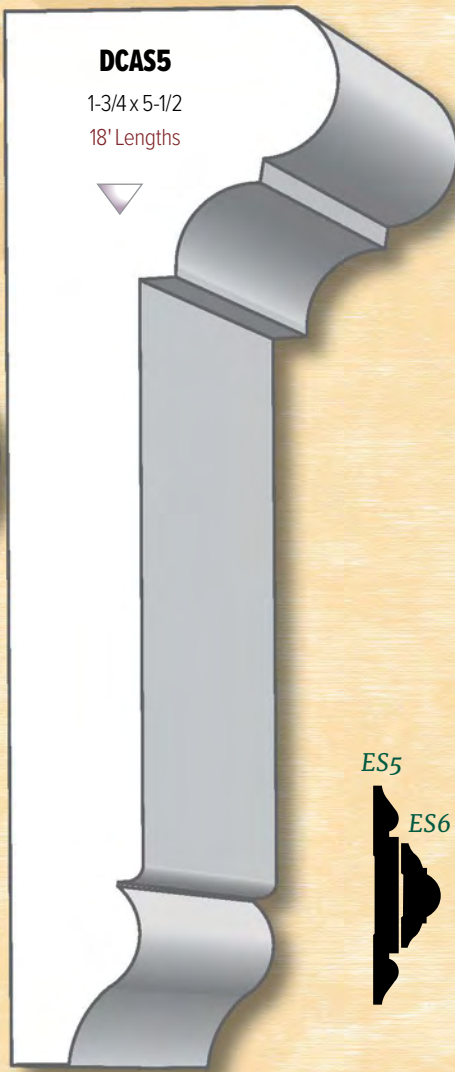
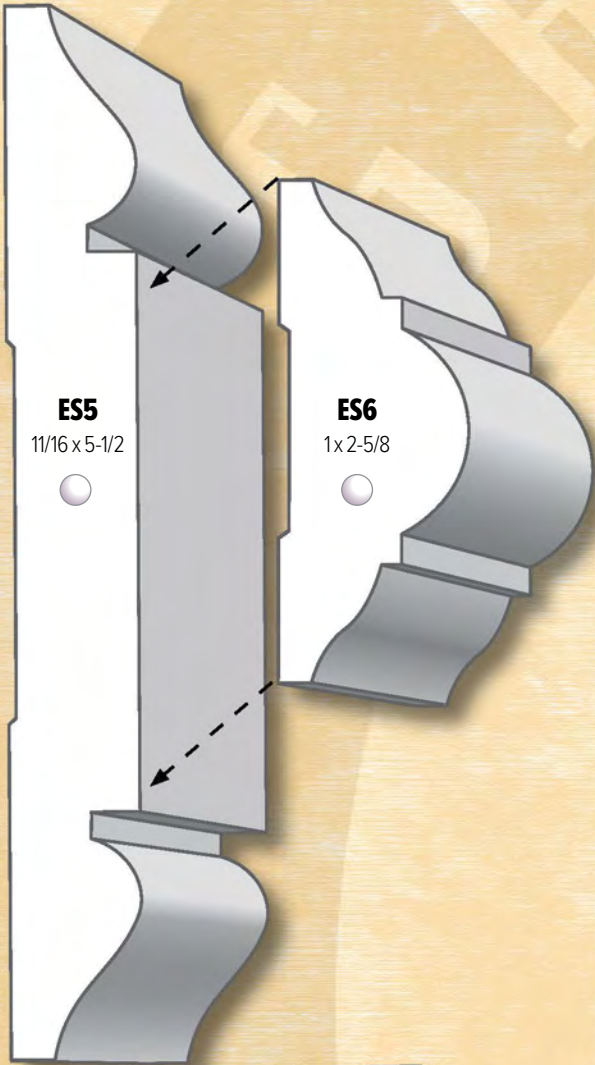

DCAS5 used as a Chair Rail



ES5 & ES6

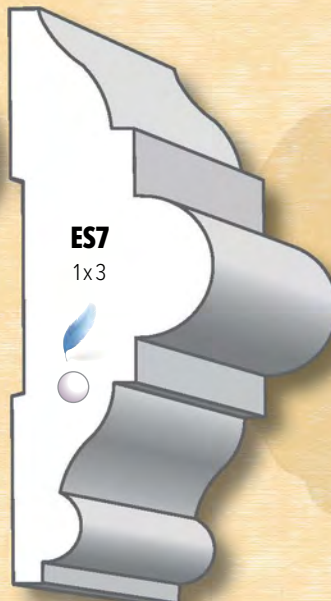
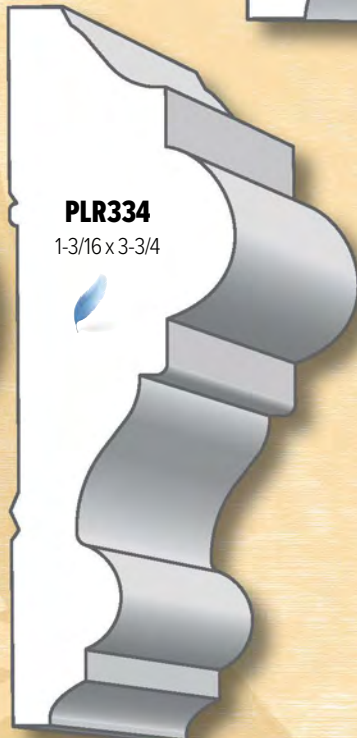
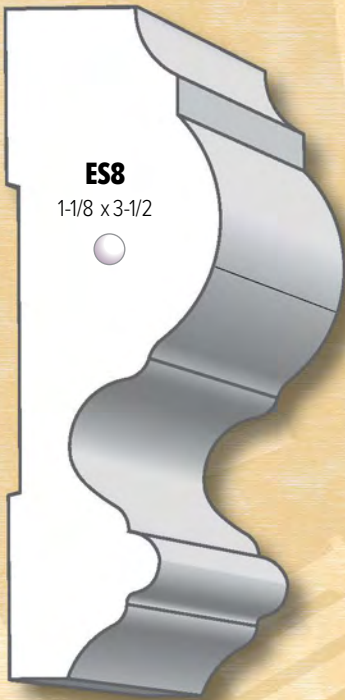

PLR334



CHAIR RAILS

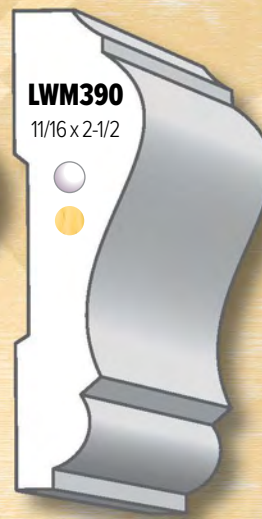
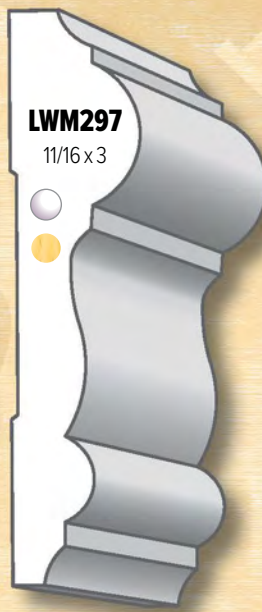
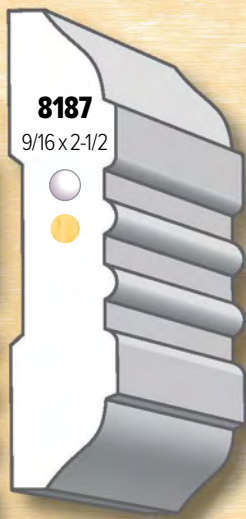
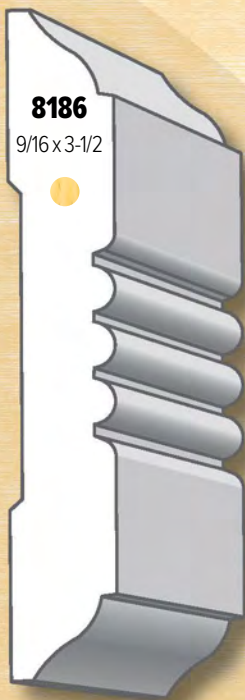

LWM390



LWM297



MCAP1 with 1" x 3"



MCAP2 with 1" x 4"

WWW.GARDENSTATELUMBER.COM

CHAIR RAILS

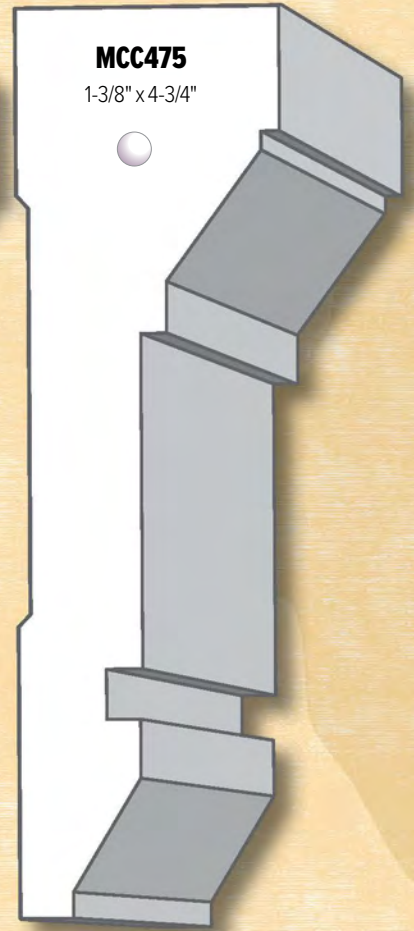
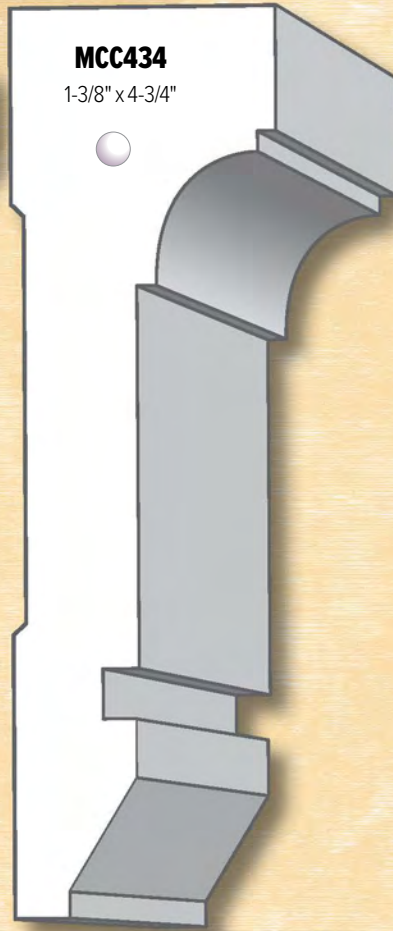
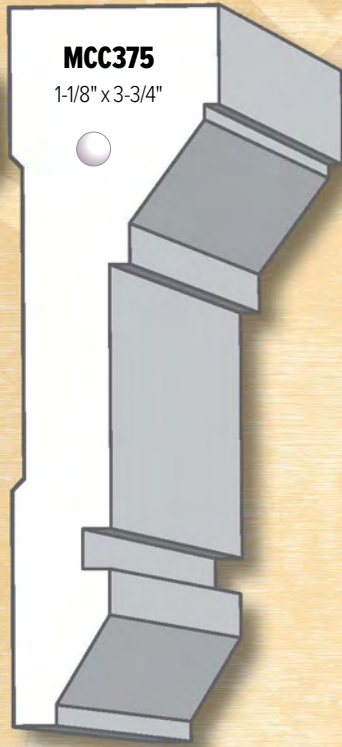
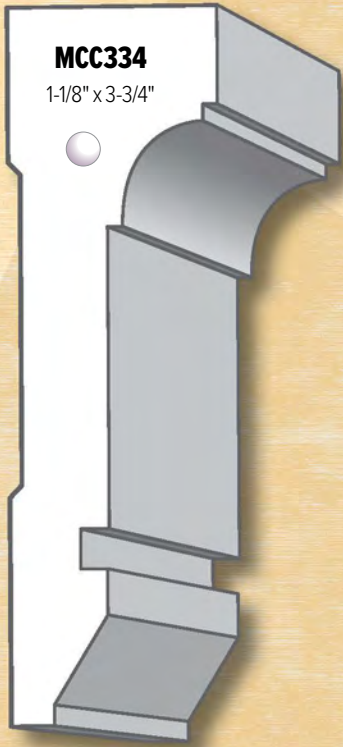

MCC434 Used as Chair Rail



MCC475 Used as Chair Rail





CROWNS

CROWNS





8027



CB312 and COV412



CB312 and UC31



COV312



UC31



COV412

CROWNS

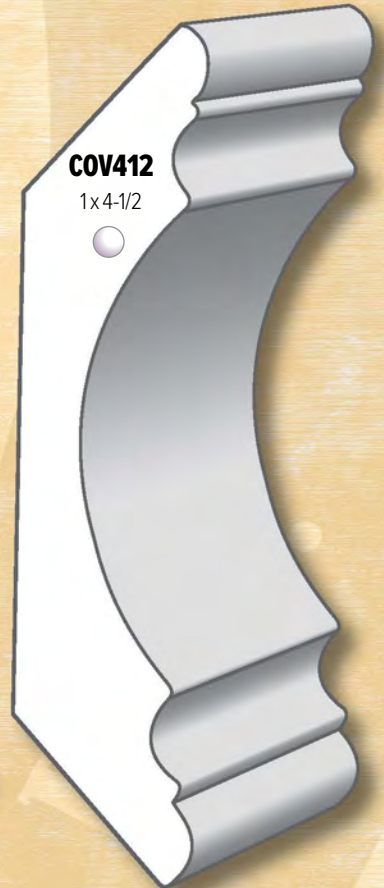
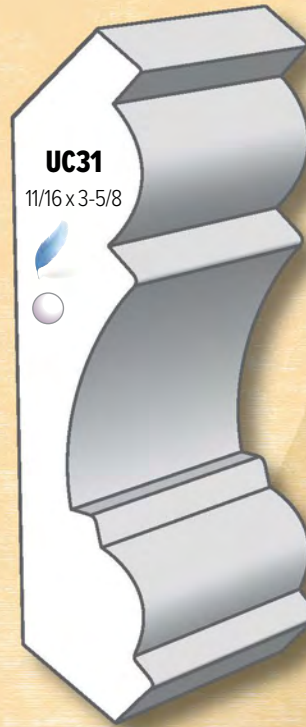
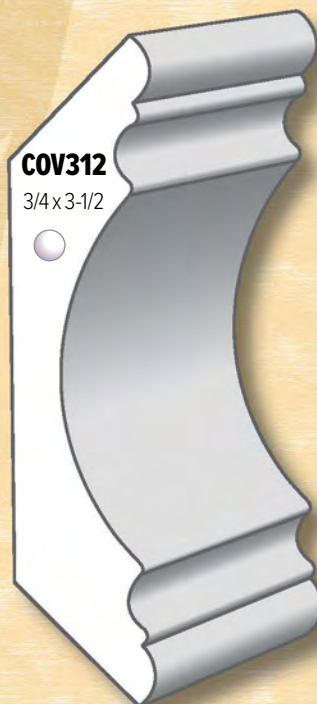
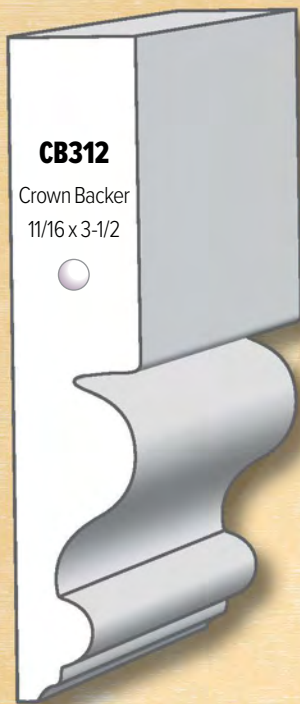

CROWNS

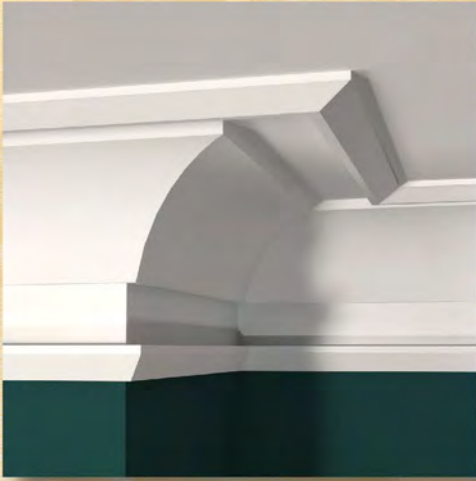

MCS1, MCOV5, MCS1



MCOV5

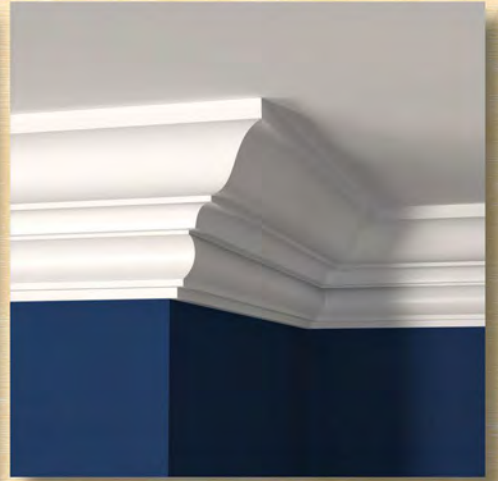

GSC412

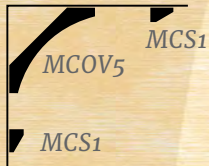

MCC412, MCOV5, MCS1

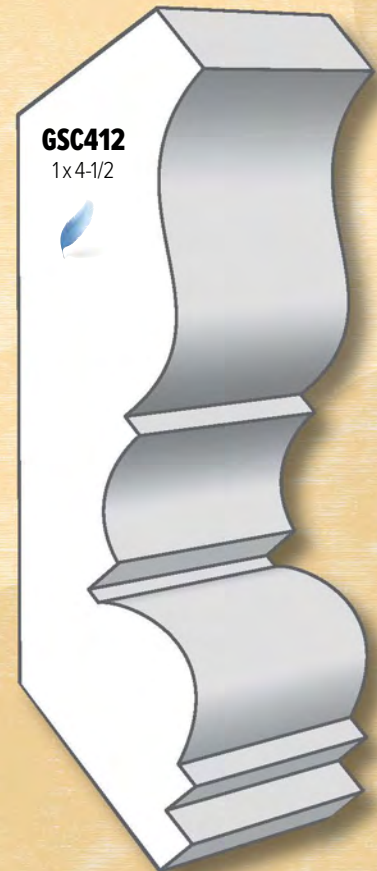
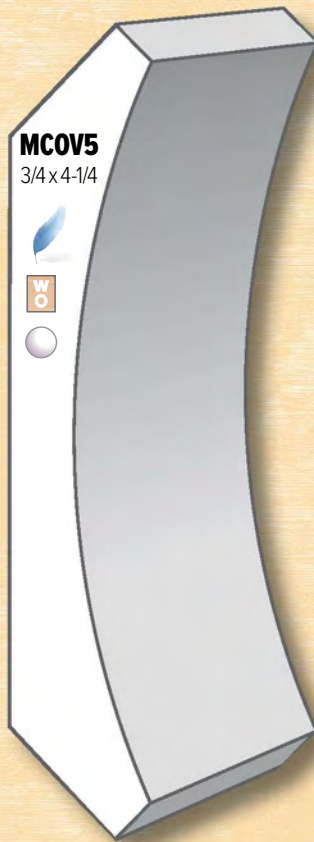
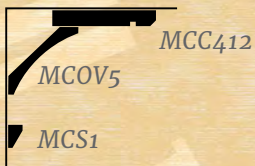

CROWNS



UC41



BC5



SBC514

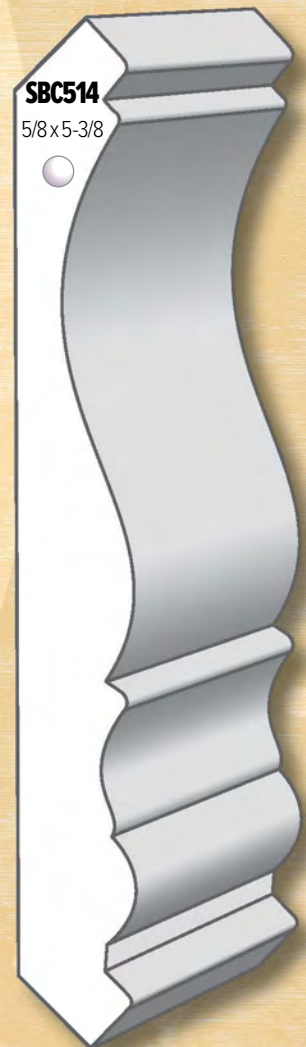
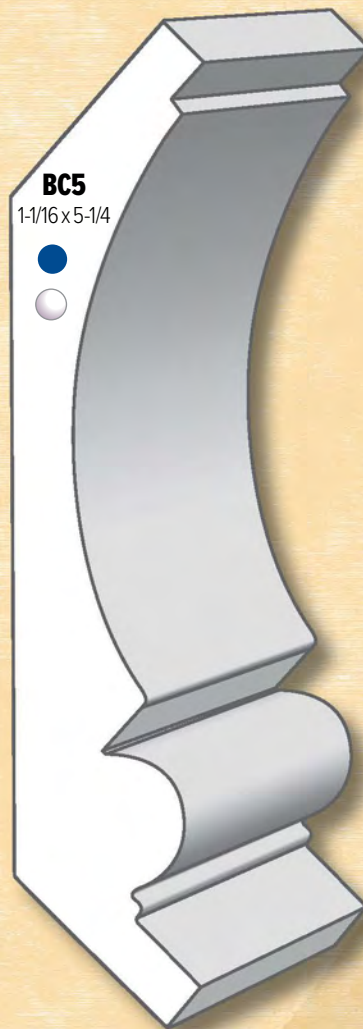
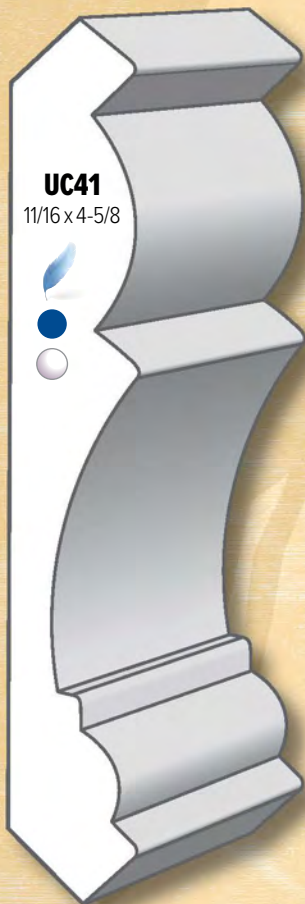

CROWNS

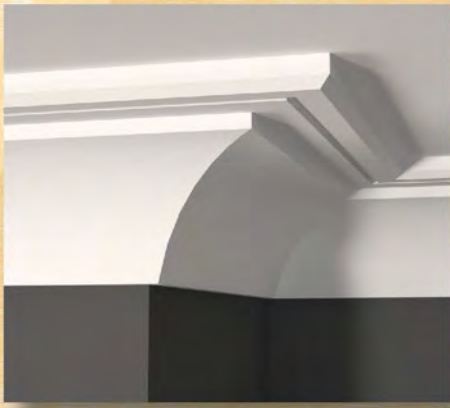

MCC312, MCOV6

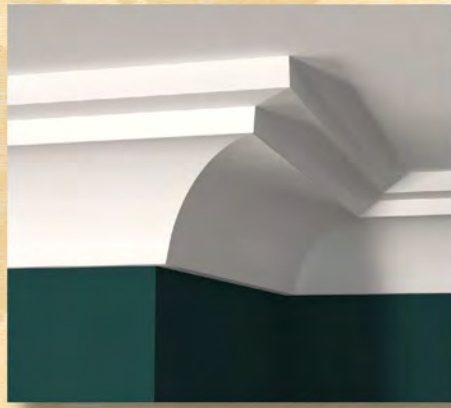
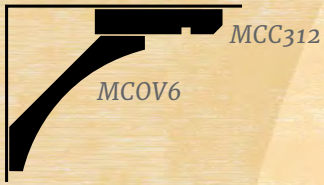

MCR514 Ceiling Step



MCR514 Wall Step



MCR514, MCC312

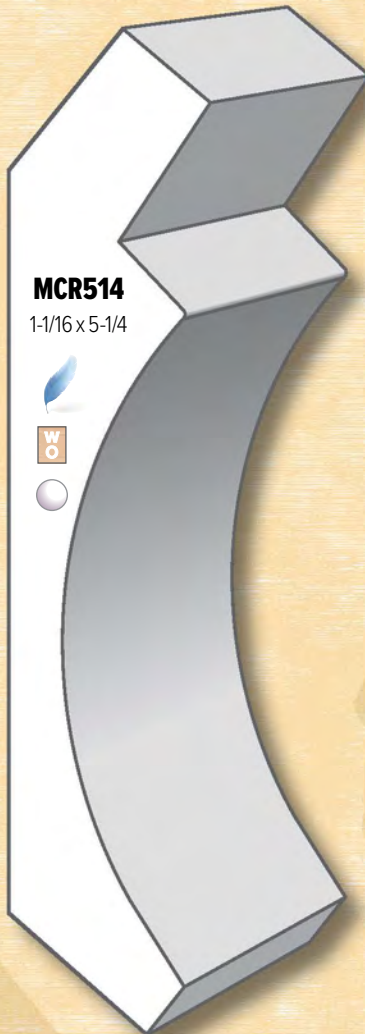
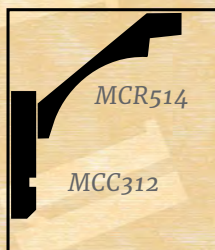



CROWNS



DCR512



MCR550 Ceiling Step



MCR550 Wall Step



MCR550



MCR550

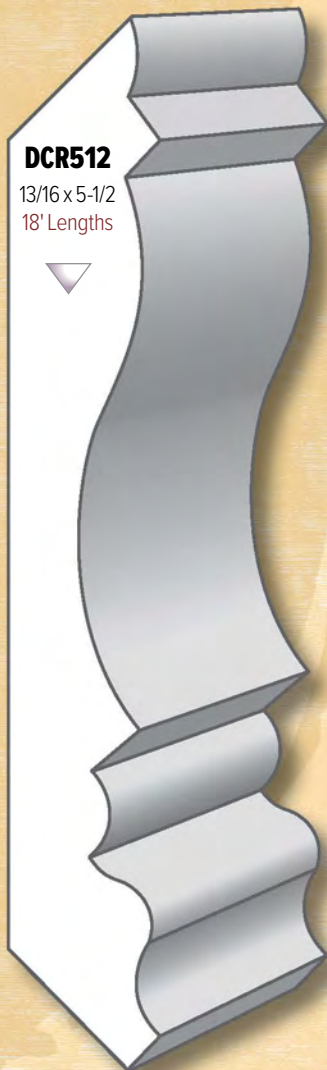

DCR512

13/16 x 5-1/2
18' Lengths



MCR550

1-1/8 x 5-1/2



MCR550 MCAP1, MCC412

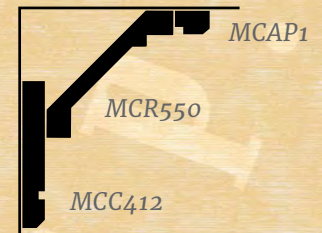

MCAP1

MCR550

MCC412

CROWNS



GSC512



UC51



DCR558

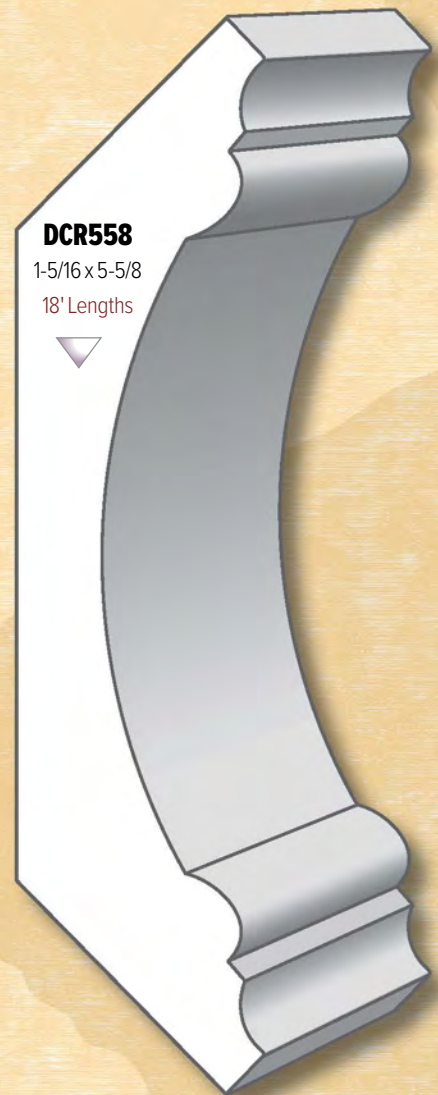
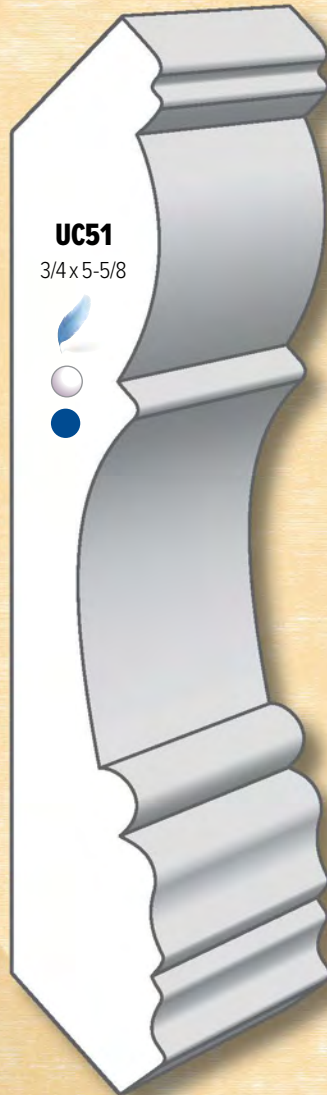
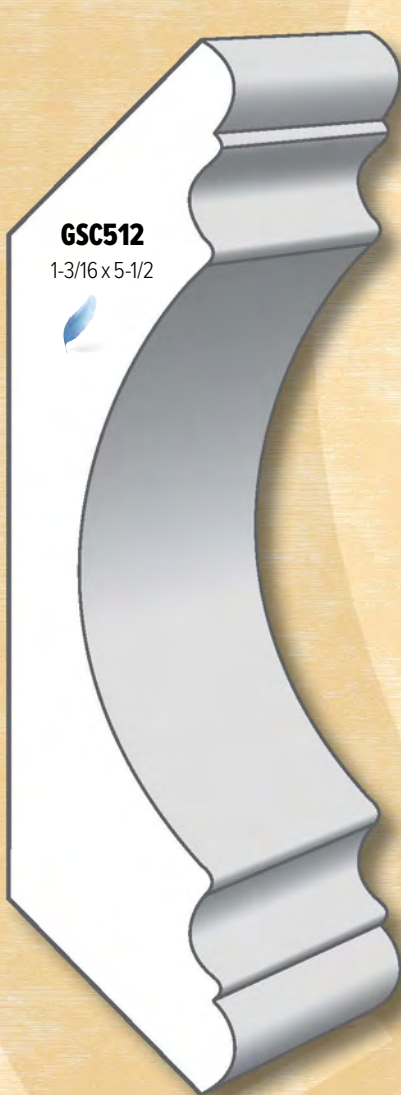

CROWNS



PLC99



GSC614



PLC612

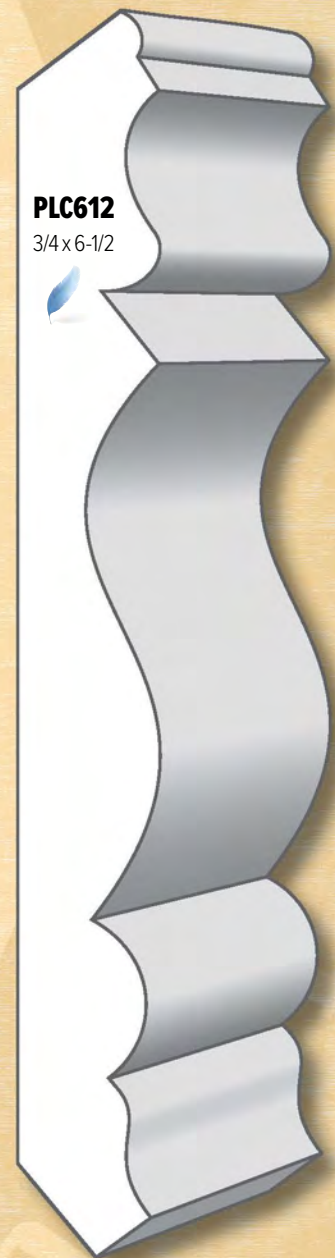
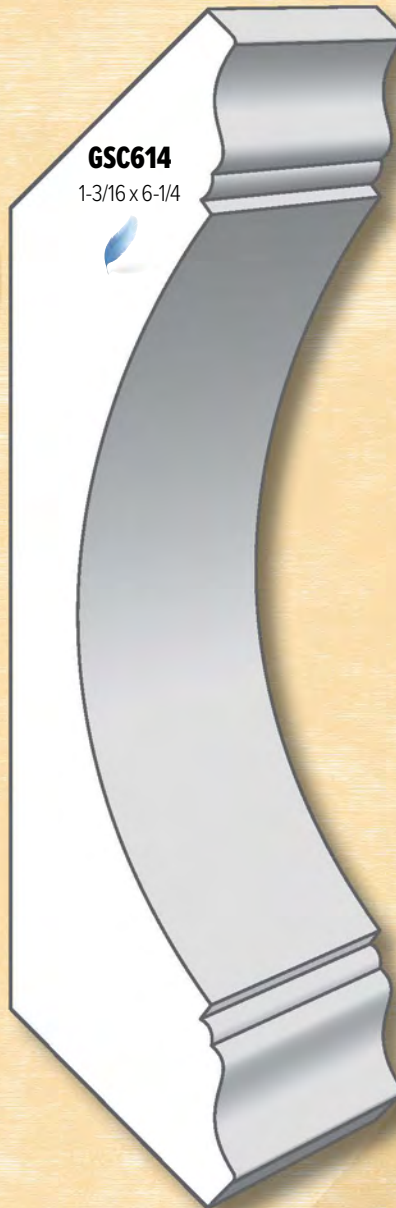
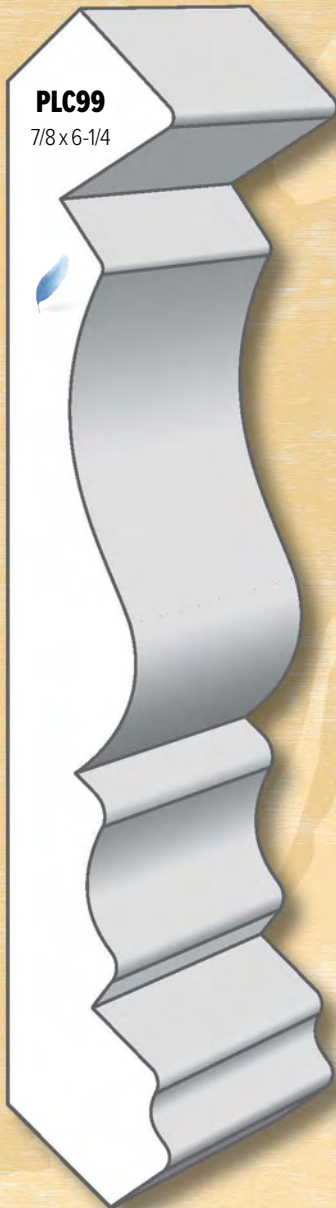

WWW.GARDENSTATELUMBER.COM



MCR650 Ceiling Step



MCR650



MCR650 Wall Step



MCR650



DCR612



MCR514, MCC312

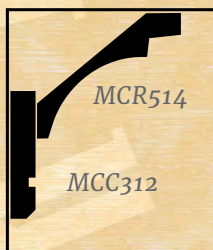

MCR514

MCC312

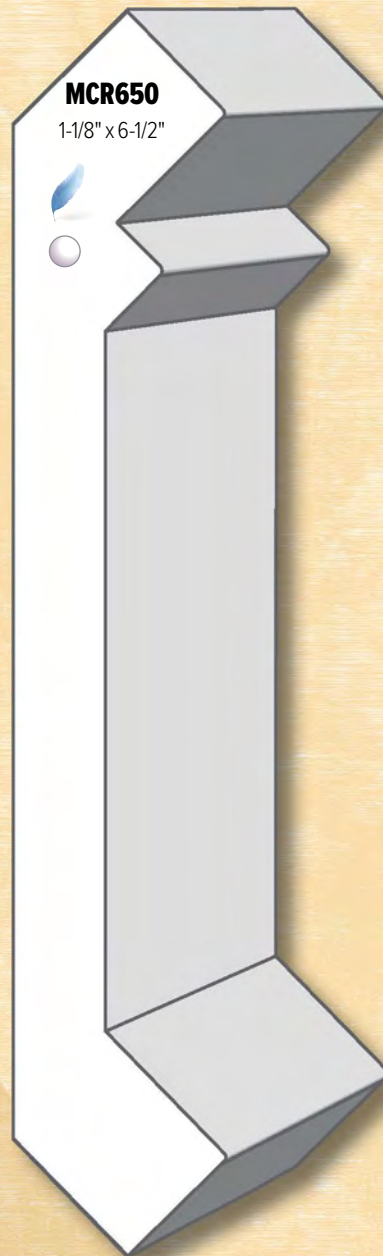

MCR650

1-1/8" x 6-1/2"

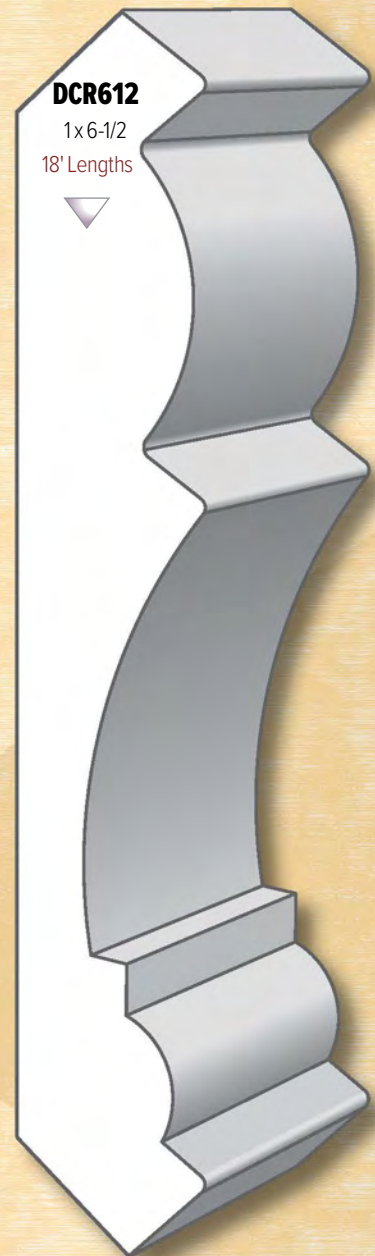

DCR612

1 x 6-1/2

18' Lengths





PLC634



DCR634



UC71



CROWNS

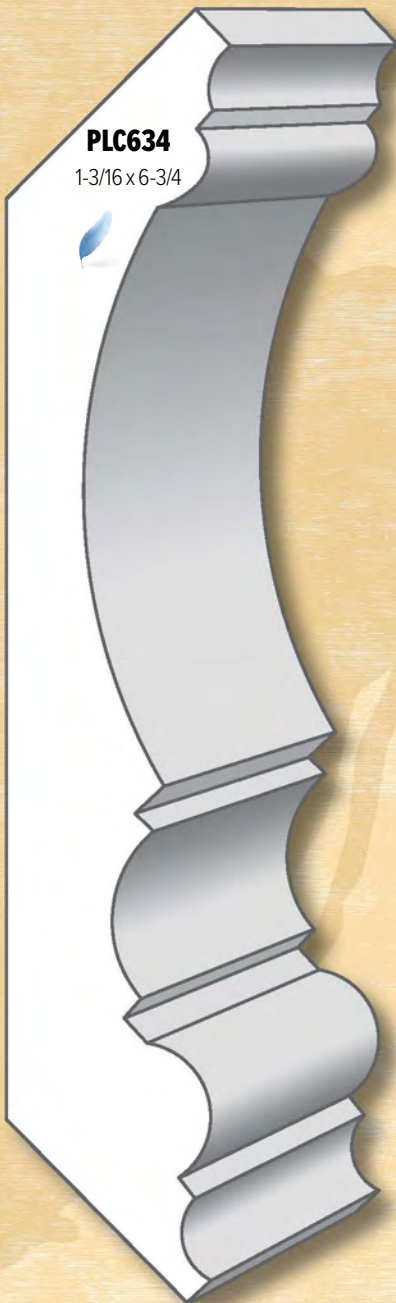

PLC634

1-3/16 x 6-3/4

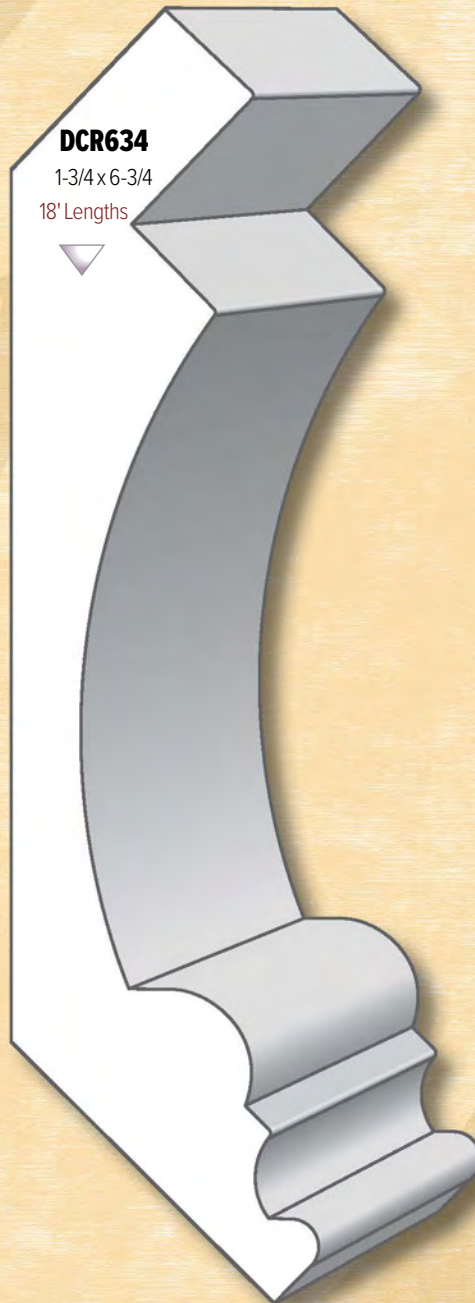

DCR634

1-3/4 x 6-3/4

18' Lengths

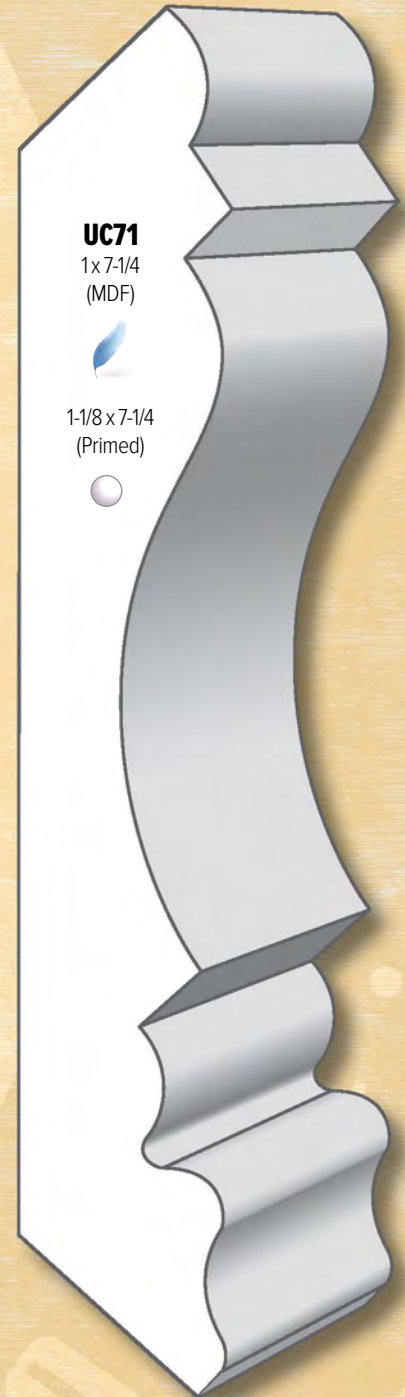

UC71

1 x 7-1/4
(MDF)



1-1/8 x 7-1/4
(Primed)





MCR714 Ceiling Step



MCOV8

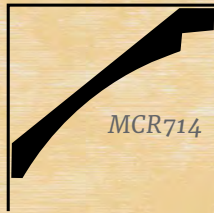

MCR714



MCR714 Wall Step

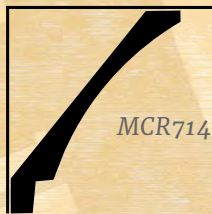

MCR714

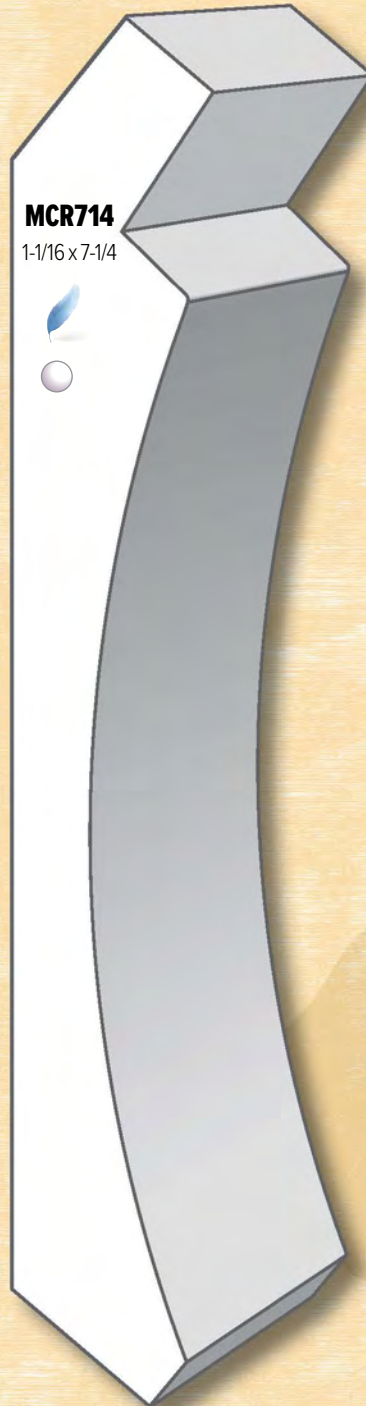

MCR714
1-1/16 x 7-1/4

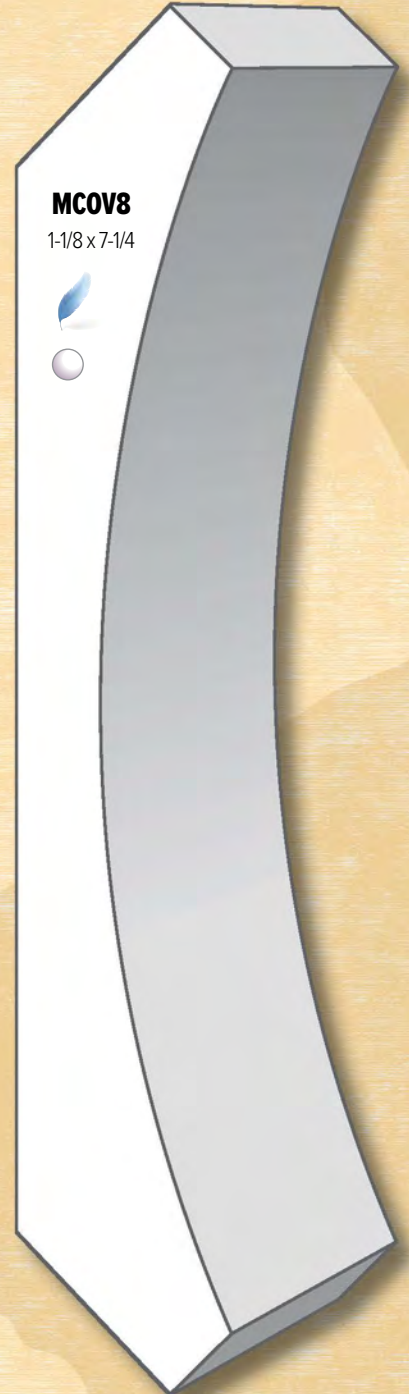

MCOV8
1-1/8 x 7-1/4





COV7



DCR725



GSC738

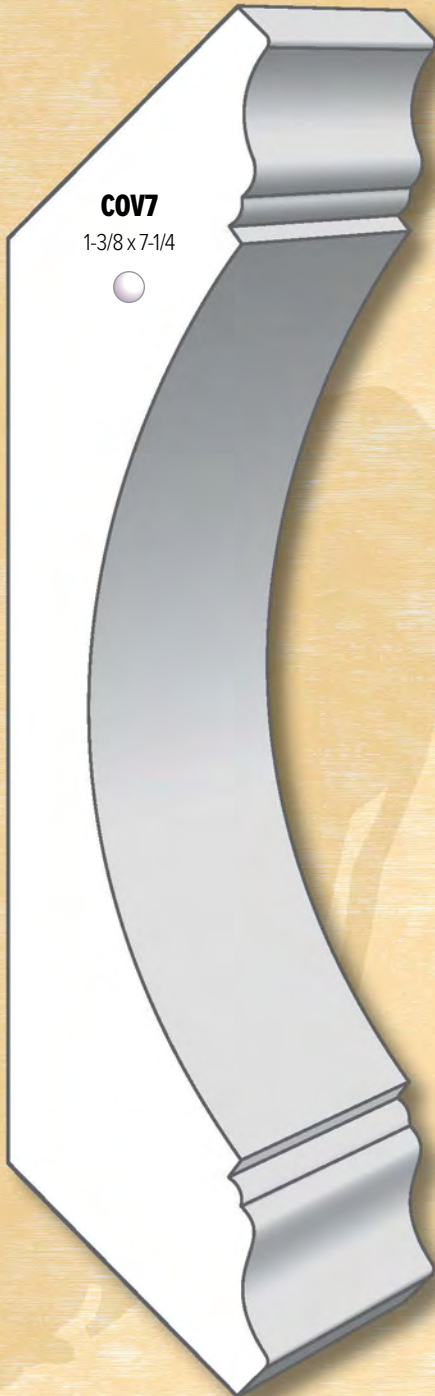

COV7

1-3/8 x 7-1/4

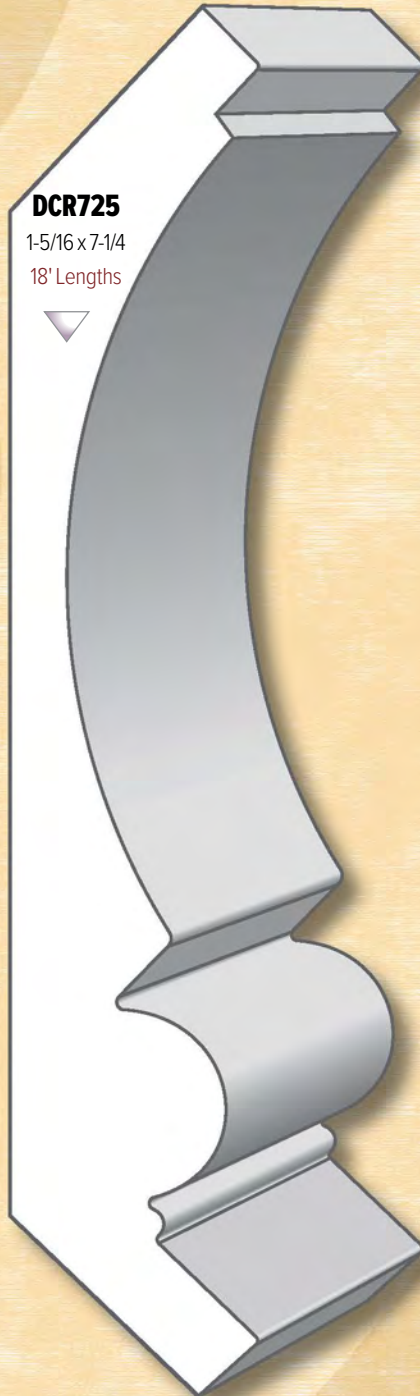

DCR725

1-5/16 x 7-1/4

18' Lengths

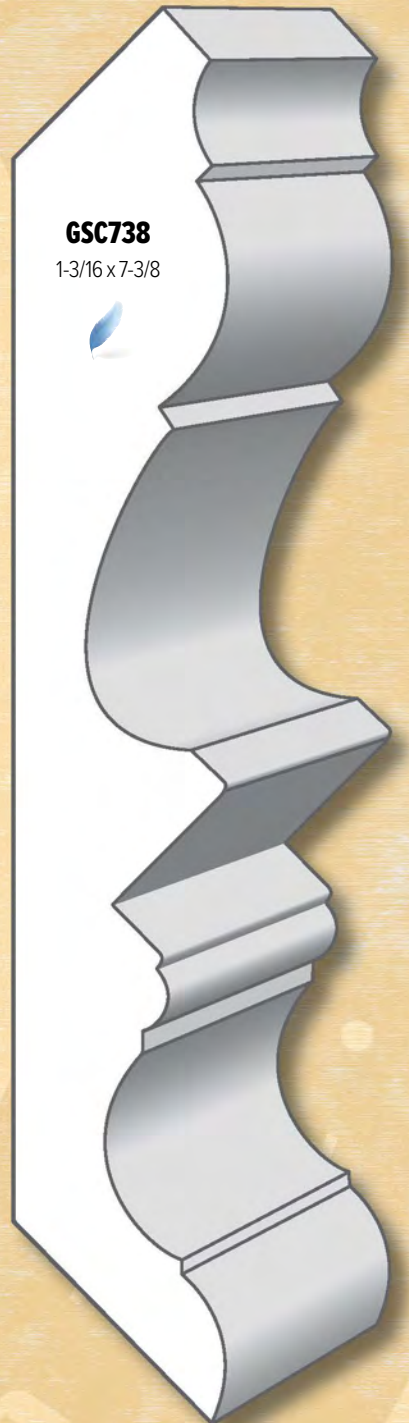

GSC738

1-3/16 x 7-3/8





MCR750 Ceiling Step



MCR750 Step on Wall, MCAP34



PLC712



MCR750 Wall Step

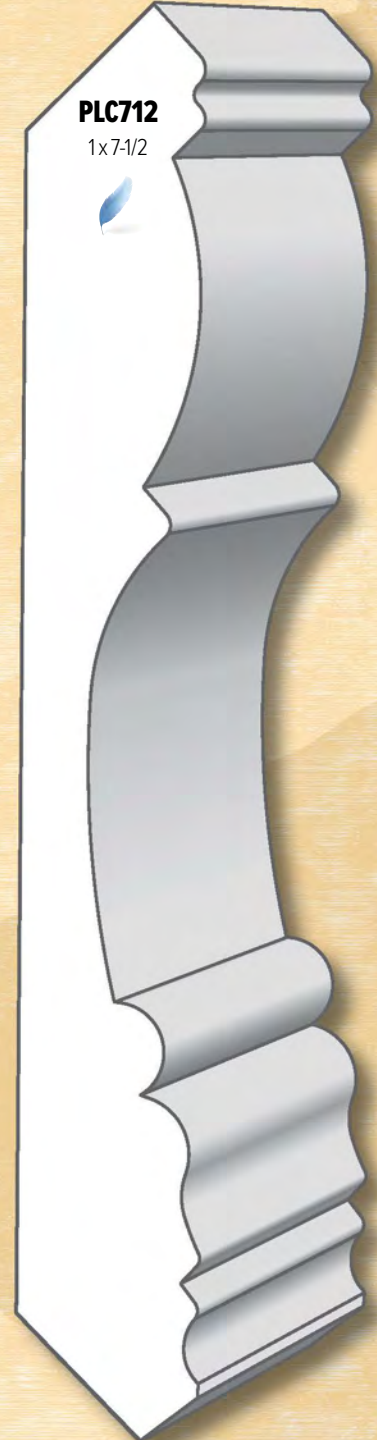



DCR734



DCR814

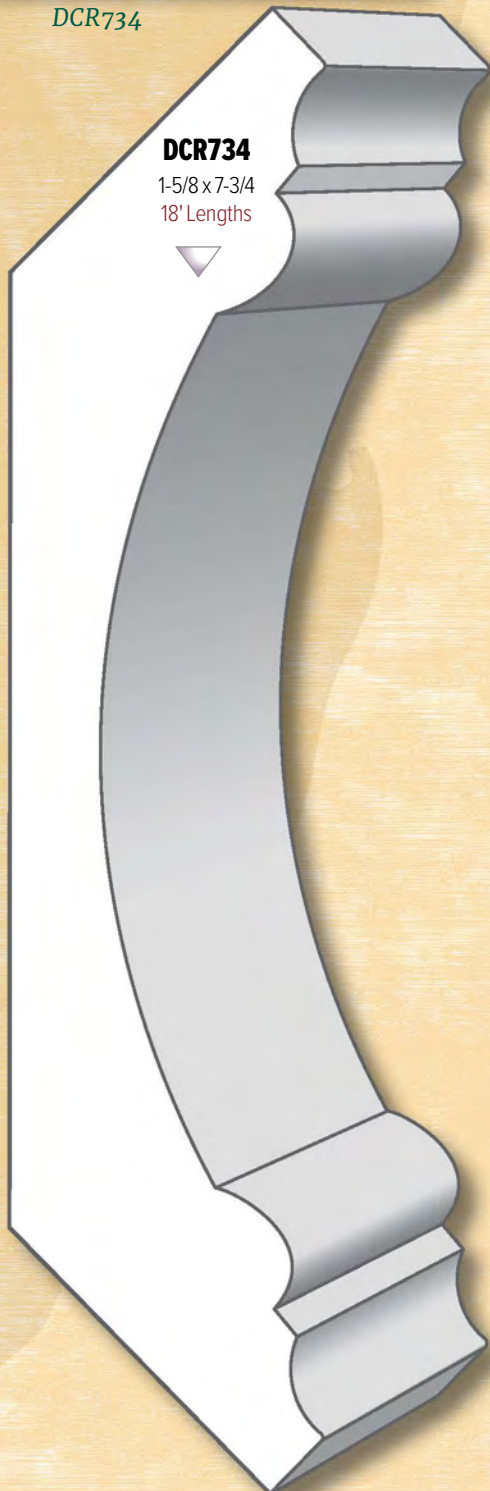

DCR734

1-5/8 x 7-3/4
18' Lengths

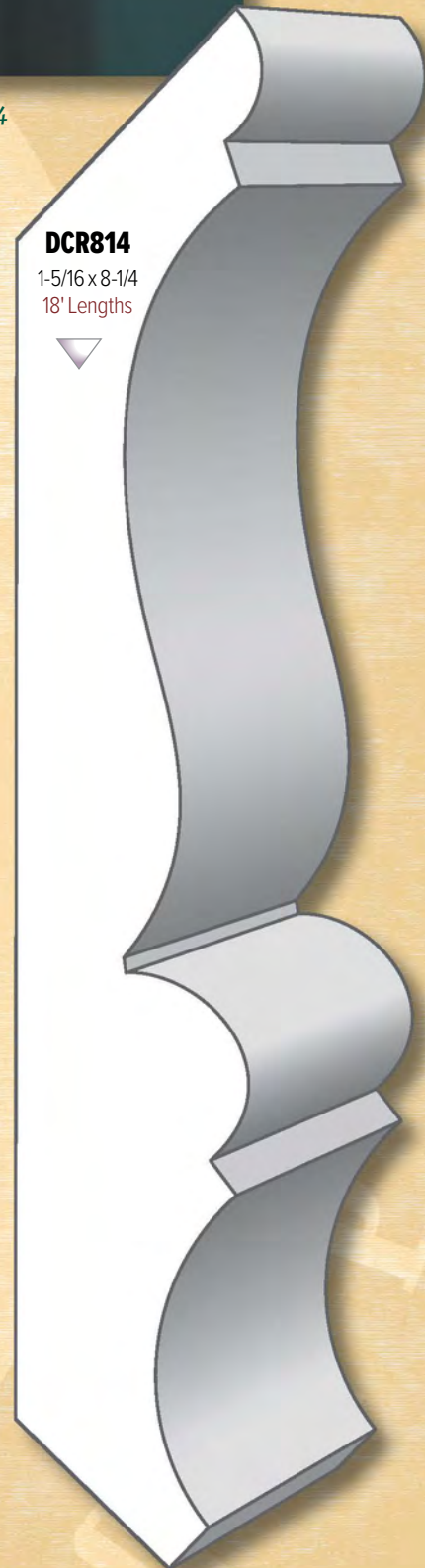

DCR814

1-5/16 x 8-1/4
18' Lengths



WWW.GARDENSTATELUMBER.COM

CROWNS



PLC812

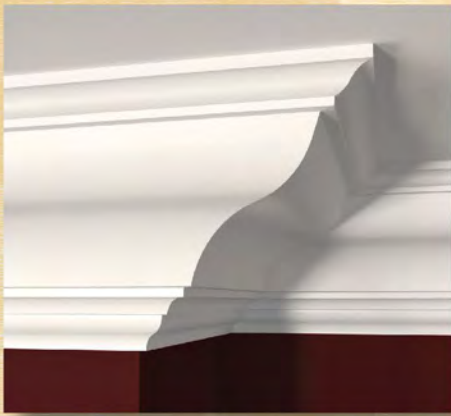

PLC1012

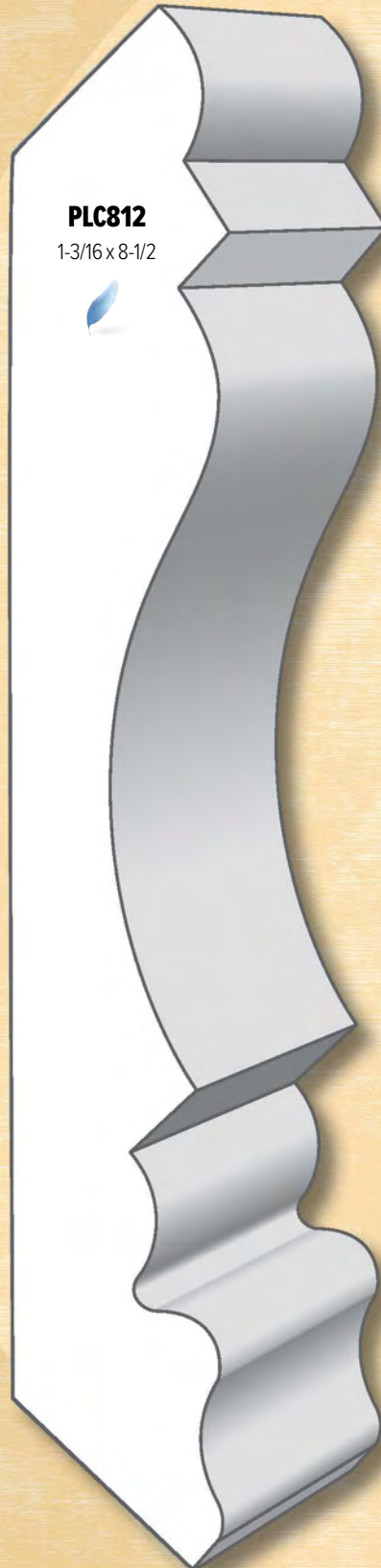

PLC812

1-3/16 x 8-1/2

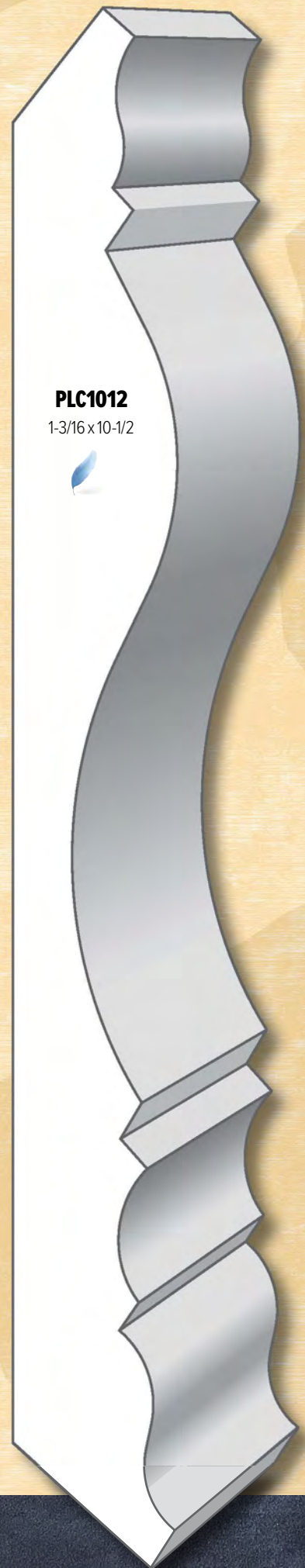

PLC1012

1-3/16 x 10-1/2





INSIDE CORNER

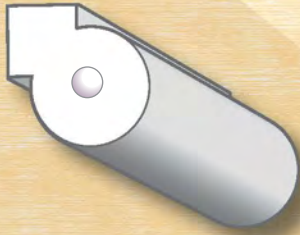

CB34
3/4 x 3/4

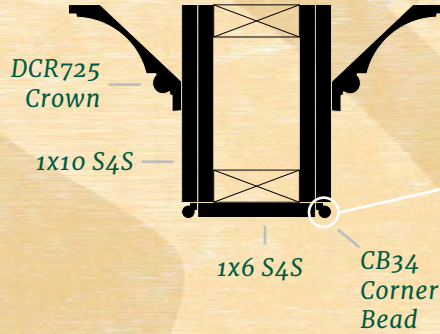

Coffered Ceiling

DENTIL MOULDINGS

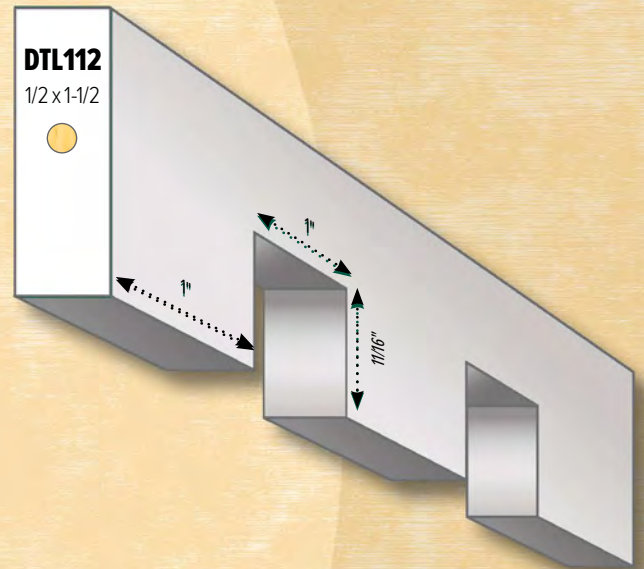
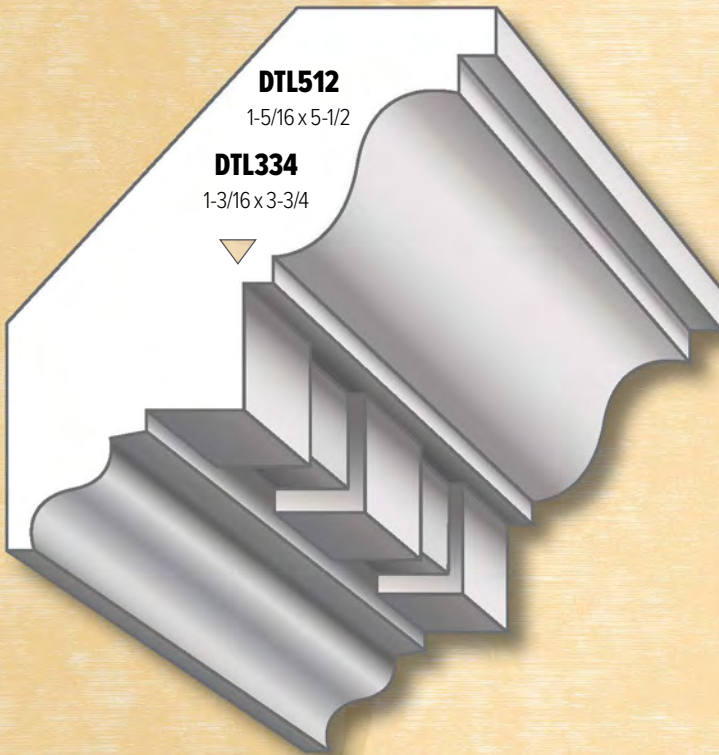

DTL512

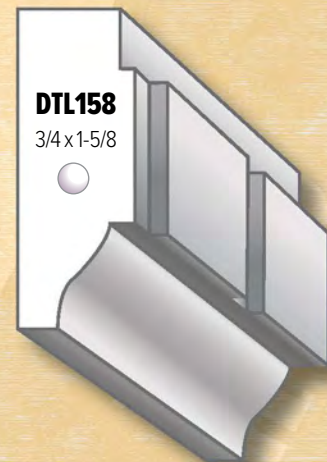

WWW.GARDENSTATELUMBER.COM

CROWNS - SOLID

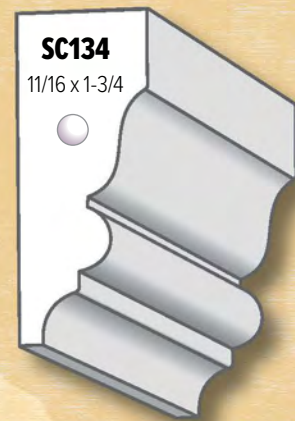
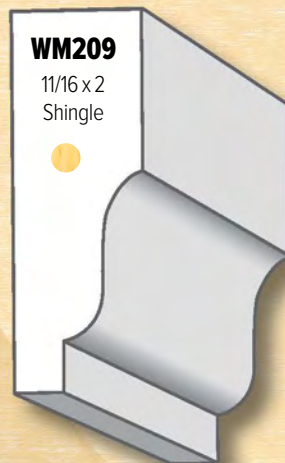
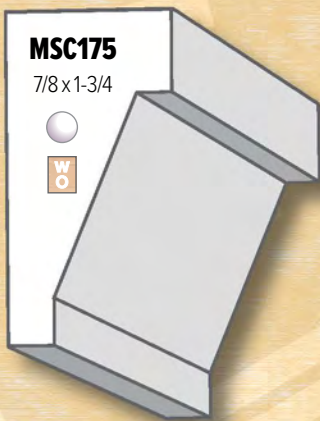
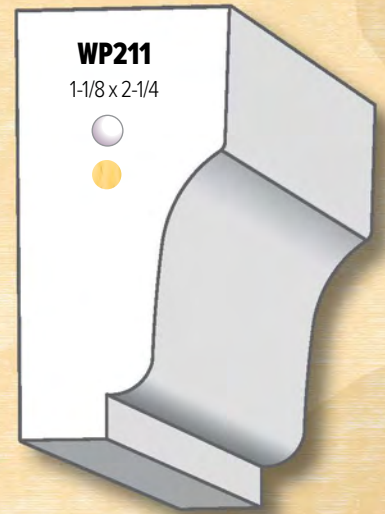
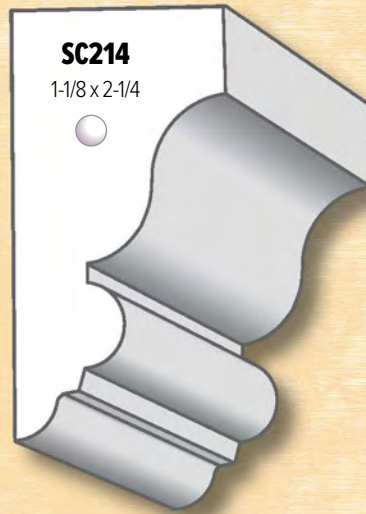
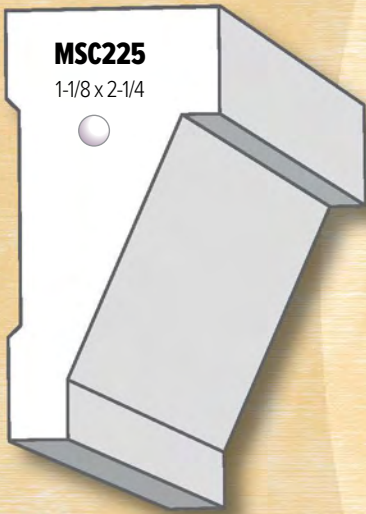
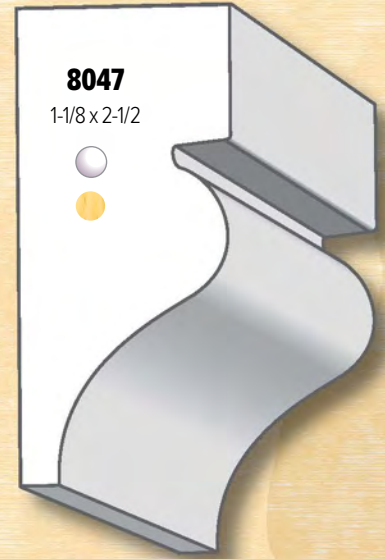
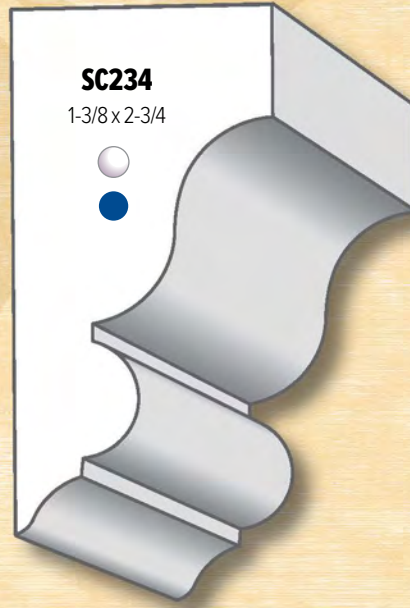
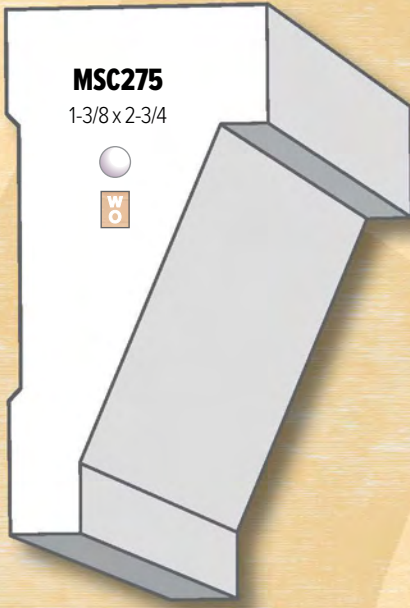

CROWNS - SOLID

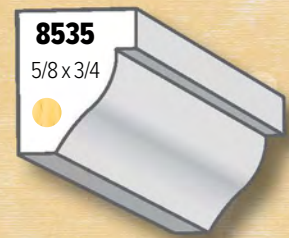
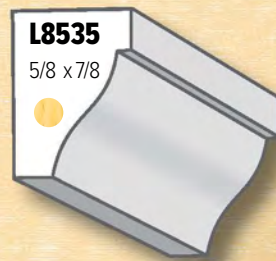
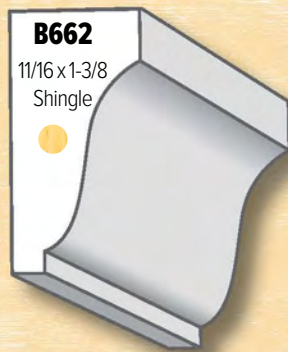
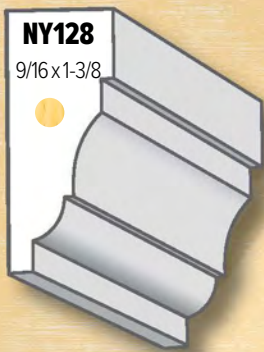
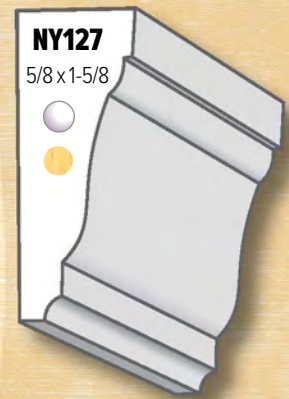
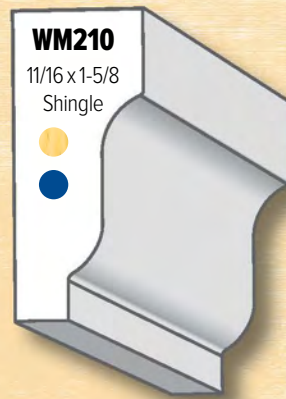
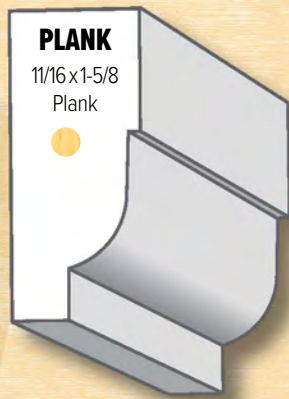
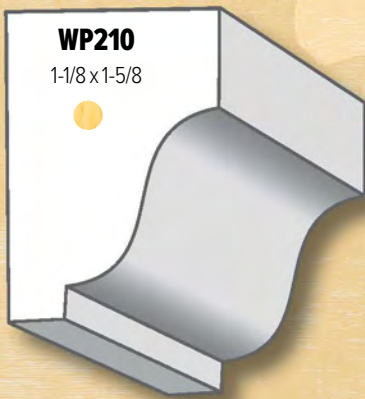

WWW.GARDENSTATELUMBER.COM

BED MOULDINGS

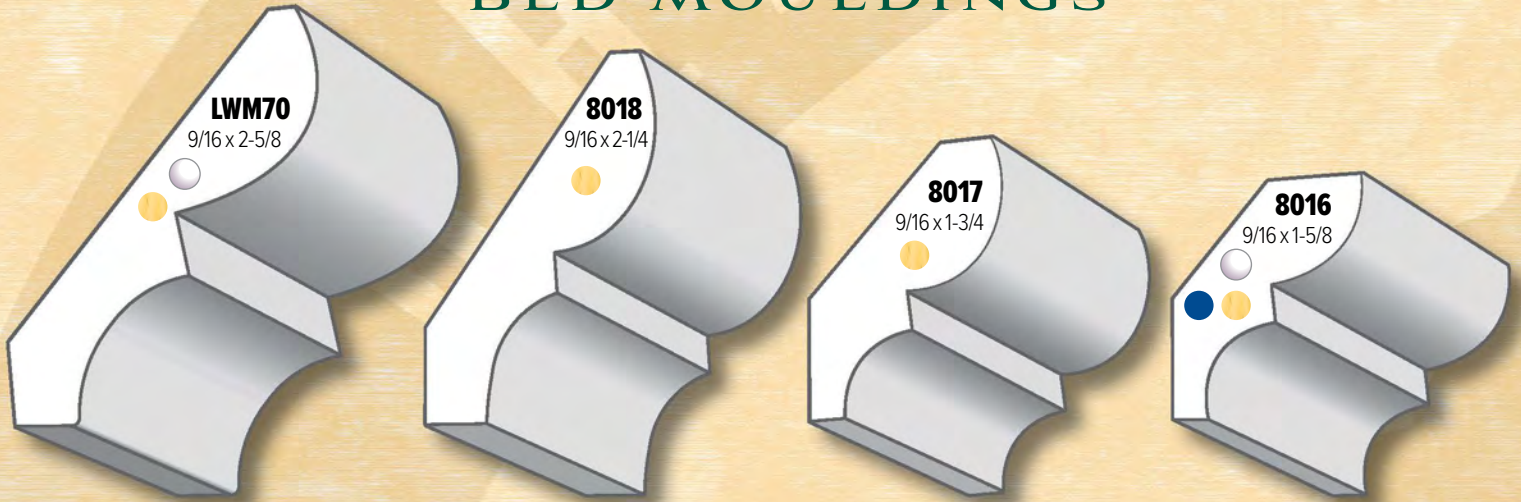

COVE MOULDINGS

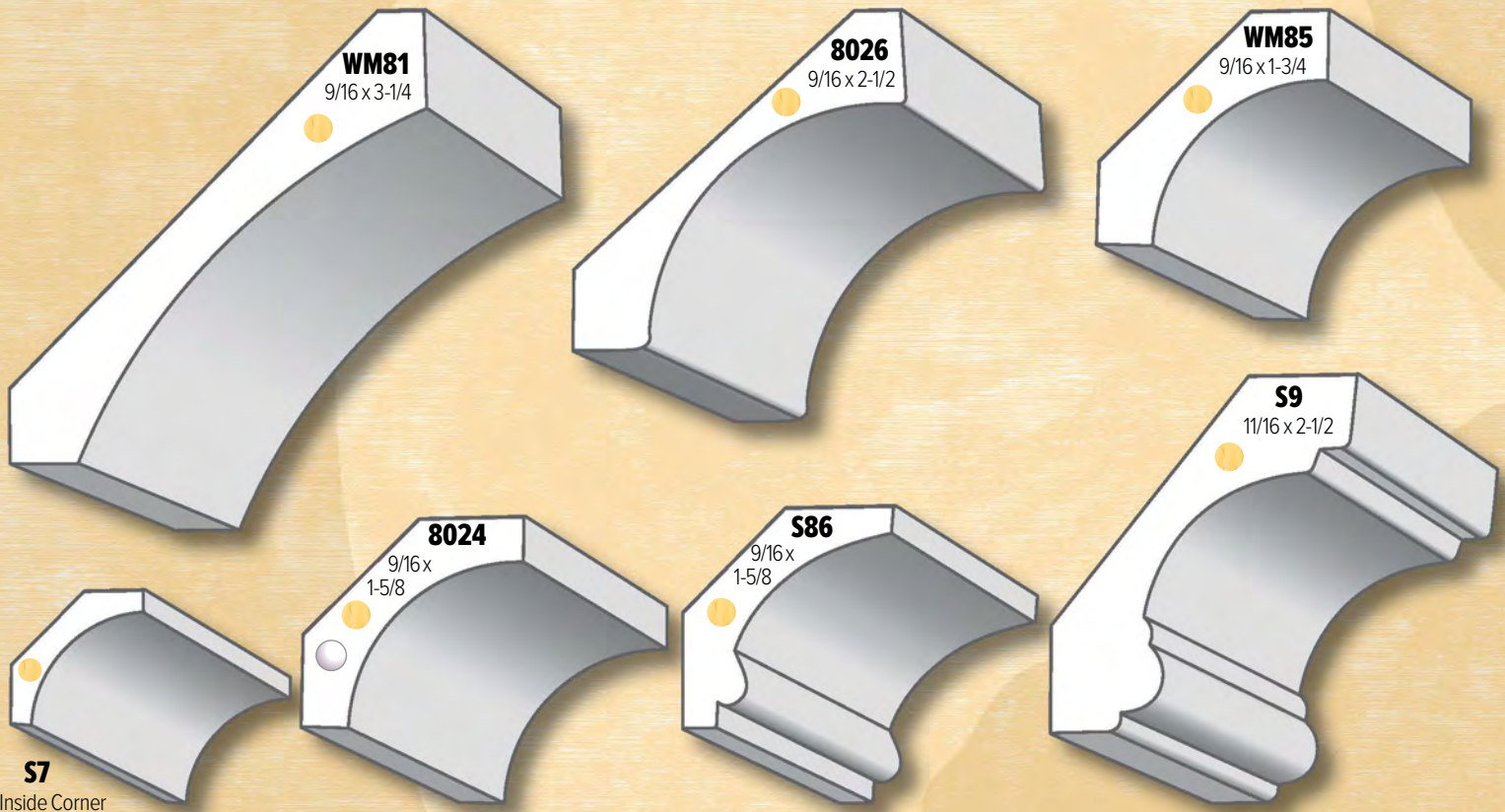

S7
Inside Corner
5/16 x 1

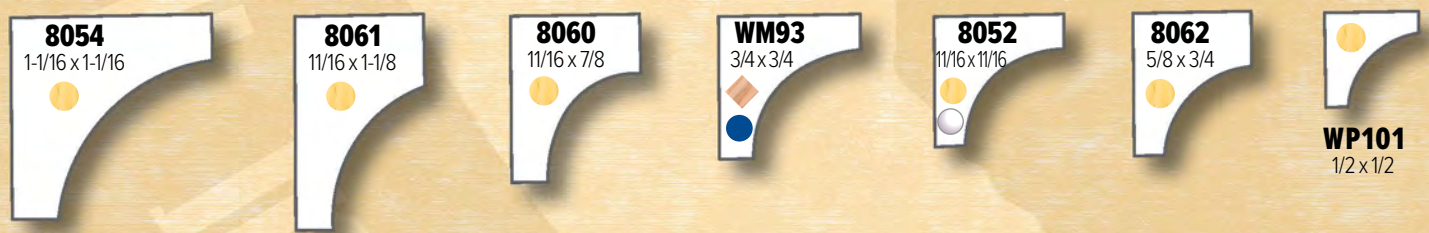

CROWNS/COVES HEIGHTS & PROJECTIONS



UC71 Crown & PLB612



PLC812 & CB312



GSC614 & GSB412
(ceiling and wall)



GSC512 & GSB412
(ceiling and wall)

SKU#	PRIMED PINE		PRIMED MDF		PRIMED POPLAR	
	HEIGHT	PROJECTION	HEIGHT	PROJECTION	HEIGHT	PROJECTION
8013*	3-1/2	2-1/2				
8027	3-7/8	3-1/8	3-3/4	3-5/8		
BC5	3-1/2	3-3/4				
COV312	2-1/2	2-1/2				
COV412	3-1/4	3-1/8				
COV7	5-1/4	5-1/4				
DCR512					3-7/8	4
DCR558					4	4
DCR612					4-3/4	4-1/2
DCR634					5-1/8	4-1/2
DCR725					5-1/8	5-1/4
DCR734					5-1/2	5-1/2
DCR814					5-1/2	6-1/8
DTL334	3-1/16	2-5/16				
DTL512	4-1/4	3-7/16				
GSC412			3-5/8	2-3/4		
GSC512			3-15/16	3-15/16		
GSC614			4-7/16	4-7/16		
GSC738			5-7/16	5-1/16		
L8009	2-1/2	2-5/16				
L8010	2	1-3/8				
L8013	3-1/2	2-5/8				
LWM47	3-5/8	2-3/4	3-1/4	3-1/4		
LWM49	2-15/16	2-1/8	2-3/4	2-1/2		
MCOV5	3	3	3	3		
MCOV6	3-5/8	3-5/8	3-5/8	3-5/8		
MCOV8	5-1/16	5-1/16	5-1/16	5-1/16		
MCR514	3-7/8**	3-1/2**	3-7/8**	3-1/2**		
MCR550	3-7/8	3-7/8	3-7/8	3-7/8		
MCR650	4-5/8	4-5/8	4-5/8	4-5/8		
MCR714	5-1/2**	4-5/8**	5-1/2**	4-5/8**		
MCR750	5-1/4	5-1/4	5-1/4	5-1/4		
PLC99MDF			4-3/4	4-1/4		
PLC612			4-1/2	4-5/8		
PLC634			4-3/4	4-13/16		
PLC712			5-1/4	5-1/4		
PLC812			6-1/8	5-7/8		
PLC1012			7-1/2	8		
SBC514	3-7/8	3-7/8				
UC31	2-1/2	2-5/8	2-7/8	2-1/4		
UC41	3-1/4	3-1/8	3-1/4	3-5/16		
UC51	3-7/8	3-3/4	4	4		
UC71	5-1/4	5-1/8	5-1/4	5		
WM47	3-5/8	2-5/8				
WM53	2	1-3/16				



UC71 Crown & BB6 Base



UC51 Crown & BB7 Base



UC41 Crown & ES3 Casing



UC31 Crown & BB458 Base

*available in clear pine only **MCR514 and MCR714 reverse dimensions for wall step use

PANELS



NOSE & COVES

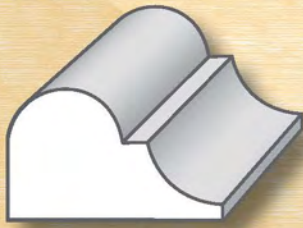

8578

11/16 x 1-1/8

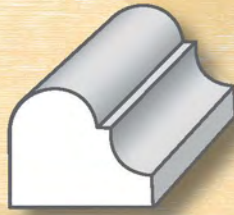

8577

5/8 x 3/4

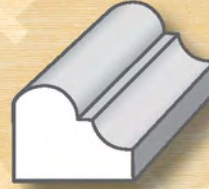

8576

1/2 x 5/8

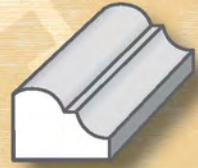

8575

3/8 x 1/2



PANEL MOULDINGS

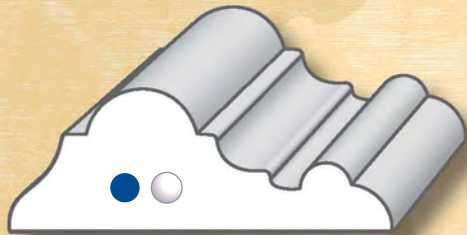

PL2

3/4 x 2

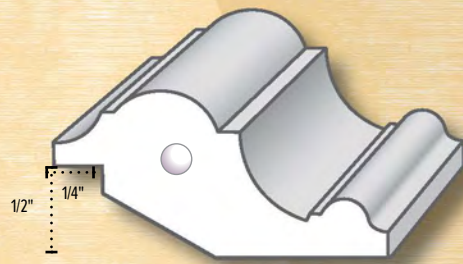

ES15

7/8 x 1-3/4

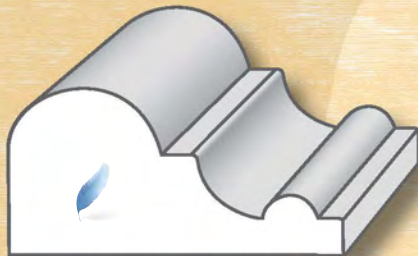

BS134

7/8 x 1-3/4

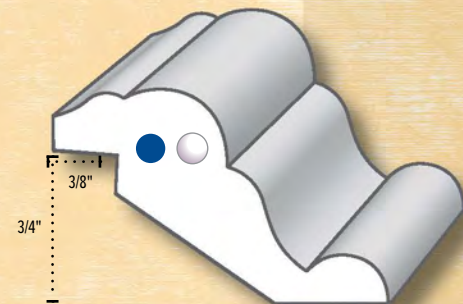

ES11

1-1/8 x 1-3/4

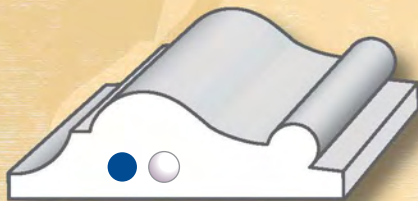

PL134

5/8 x 1-3/4

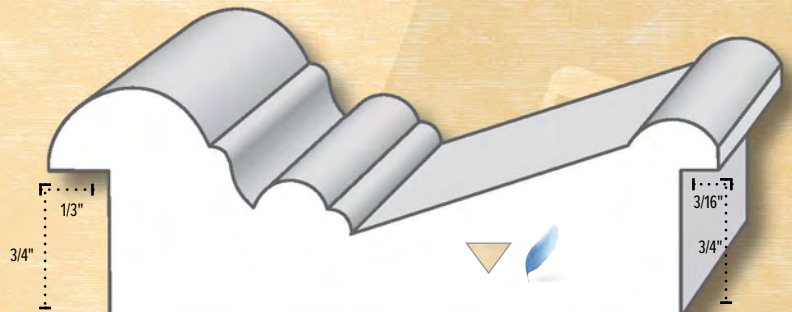

PLP312

1-3/16 x 3-1/2





cap (ECBCAP)

1x8

panel (BC78)

drywall

panel (BC78)

1x12

base cap (BC78)

1x6



PL2RCMDF
4-1/2" Radius



PL134RCMDF
4-1/2" Radius



8416RCMDF
4-1/2" Radius



BASE CAP/PANEL

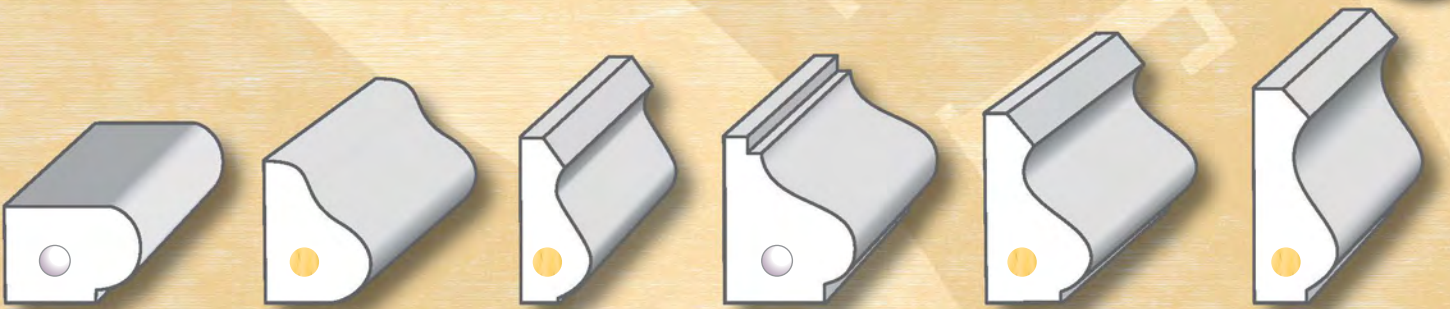

BDBCAP
3/4x1/2

B34
9/16x3/4

PL78
3/8x7/8

BC78
11/16x7/8

B658
9/16x1

PL118
3/8x1-1/8

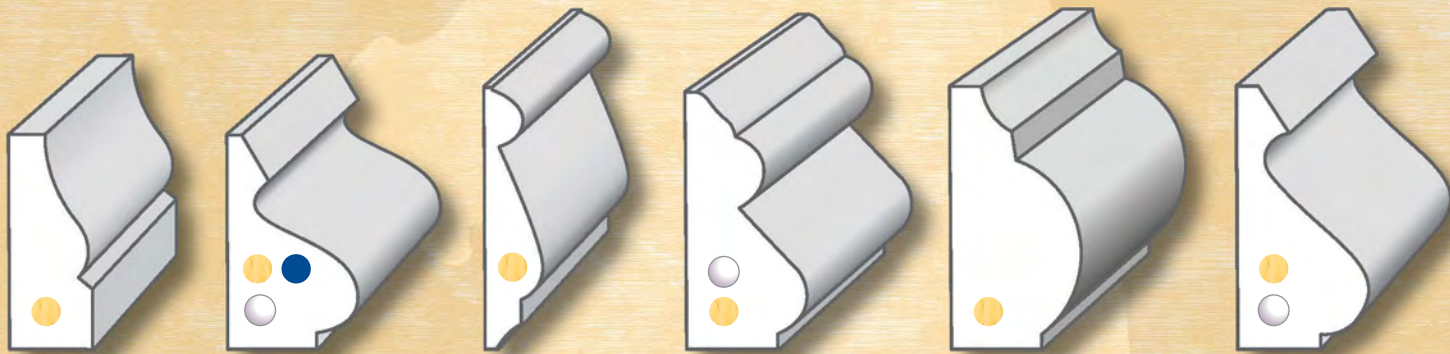

B608
7/16x1-1/8

WM164
11/16x1-1/8

PL138
5/16x1-3/8

8412
5/8x1-3/8

BB138
11/16x1-3/8

WM163
11/16x1-3/8

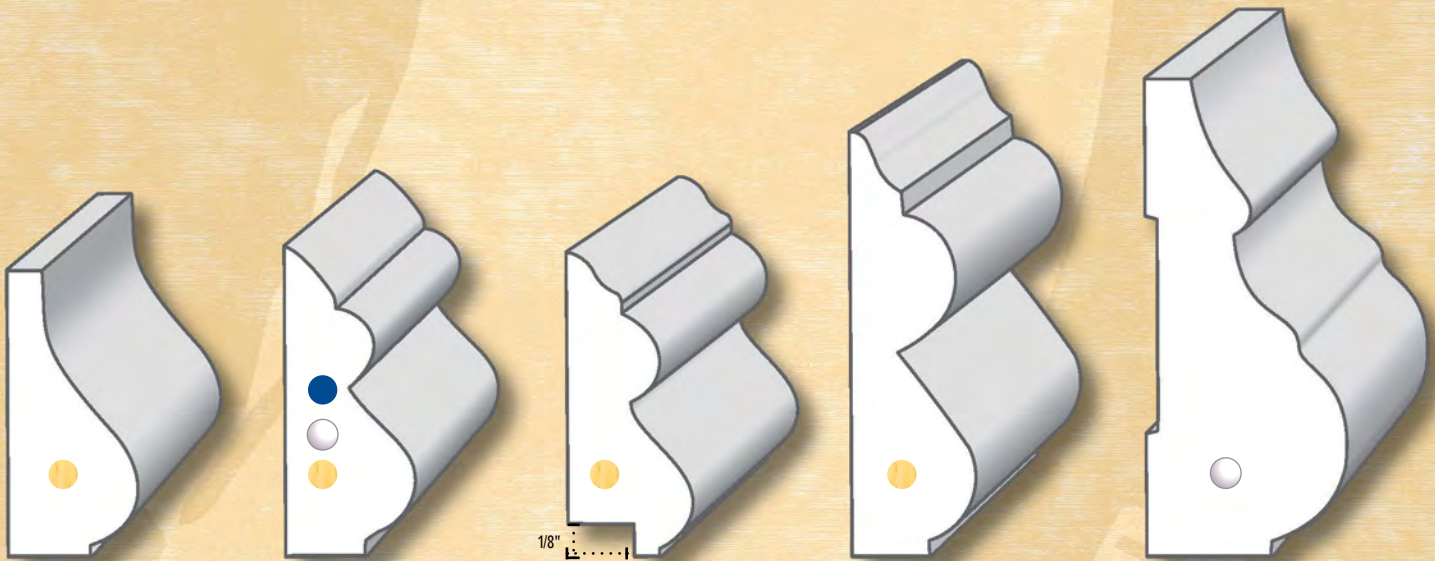

B660
11/16x1-1/2

8416
5/8x1-5/8

8409
11/16x1-5/8
1/8" 5/16"

8417
11/16x2-1/4

ES9
1-1/16x2-1/2

BASE CAP/PANEL

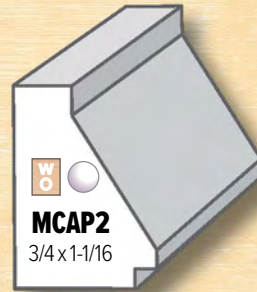
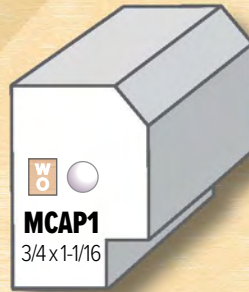
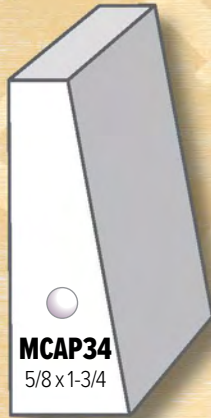
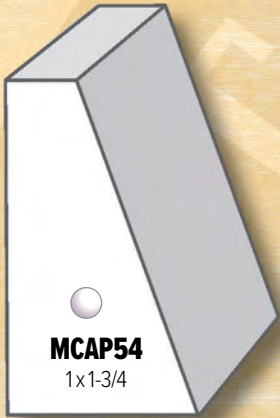

MODERN SHOE

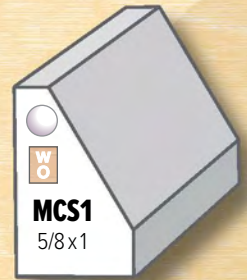

BASE CAP/PANEL USED IN BASE APPLICATIONS



MCS1 Shoe used as cap, 1" x 6", MCS1 Shoe Moulding



MCAP2 Cap, 1" x 6", MCS1 Shoe Moulding



MCAP1 Cap, 1" x 8", MCS1 Shoe Moulding



MCAP34 Cap, 1" x 6", MCS1 Shoe Moulding



METRO COLLECTION PANEL APPLICATION



MCAP54, MCS1, 1" x 6", 1" x 12"



MCAP34, 1" x 6", 1" x 12"

METRO COLLECTION PANEL APPLICATION

- 1" x 3" MSC175
- 1" x 6" MCAP2
- MCAP2
- 1" x 4" MCAP2
- MCAP2
- Drywall
- MCAP2
- 1" x 10" MCAP2
- 1" x 5" MCS1



MSC175, MCAP2, MCS1, 1" x 3", 1" x 4", 1" x 5", 1" x 6", 1" x 10"

- 8121 MSC225
- 1" x 6" MCAP1
- Drywall
- MCAP1
- 1" x 12" MCB712
- MCS1



8121, MSC225, MCAP1, MCB712, MCS1, 1" x 6", 1" x 12"

EDGE & CENTER BEAD CAP

WAINSCOT CAPS

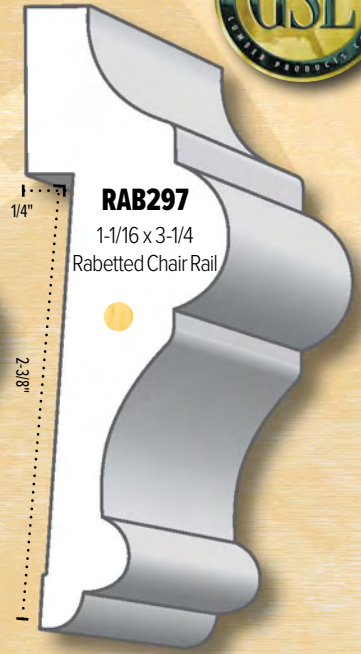
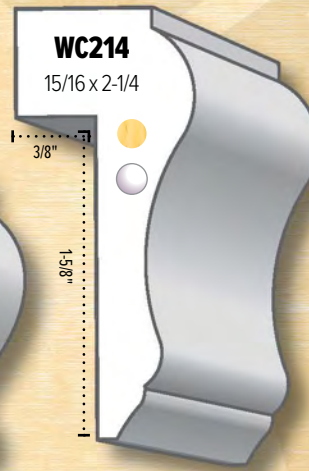
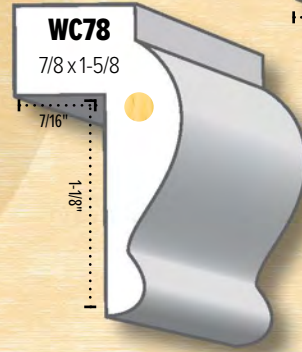
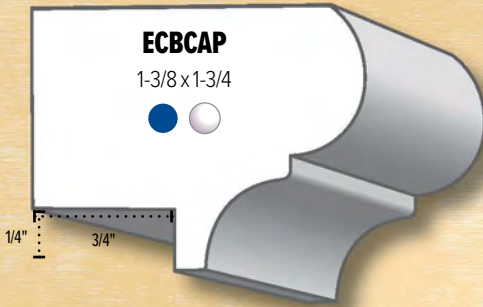
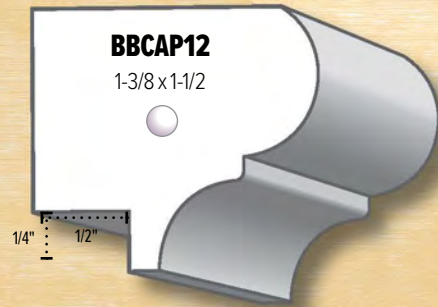

nantucket®
beadboard
See our full offering of
Beadboard Panels and Strip Products

BBCAP12, 4" On Center Modern Groove Sheets, 8" Modern Shiplap Strips, BC5 Crown, SAN525 Base

WWW.GARDENSTATELUMBER.COM

BAND / RAKE MOULDINGS

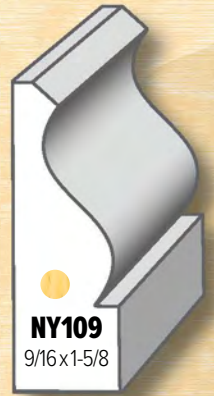
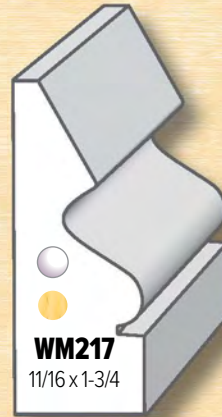
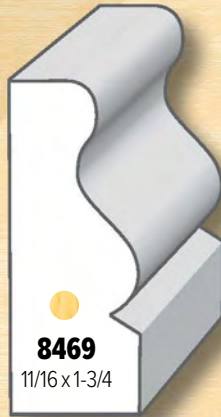
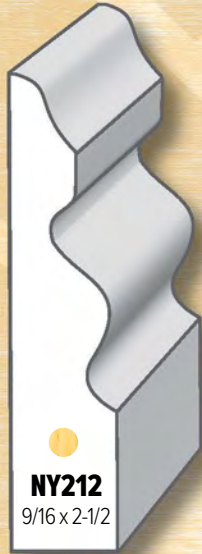
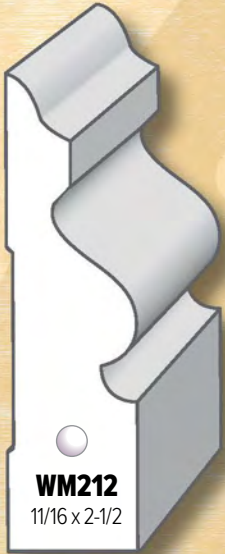

EXTERIOR CASINGS

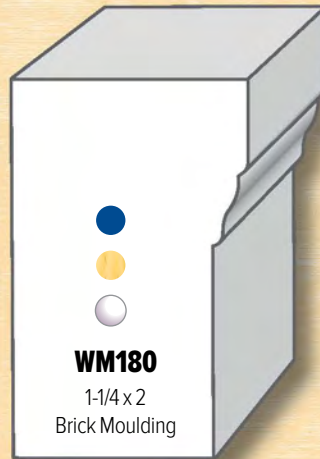
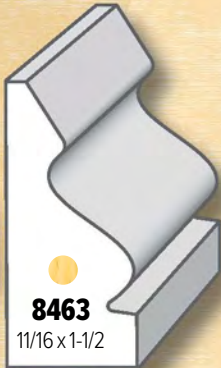
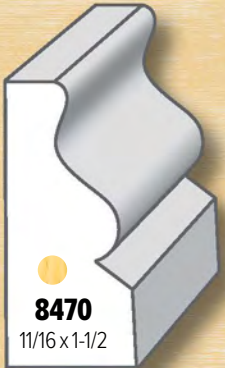

BALUSTERS

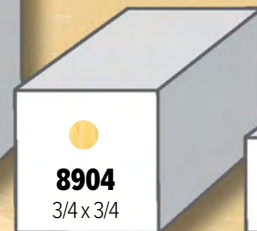
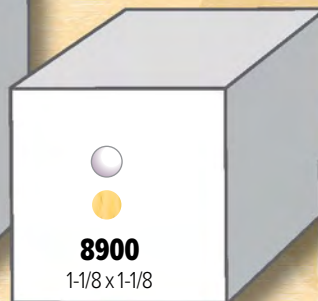
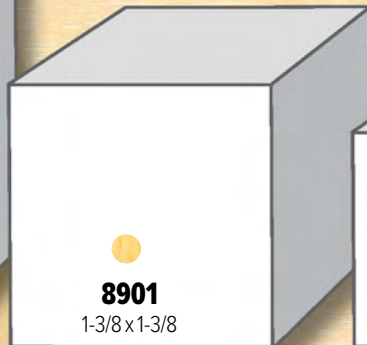
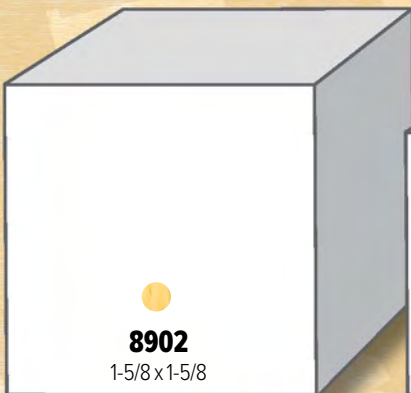

ASTRAGALS & MULLION CENTERS

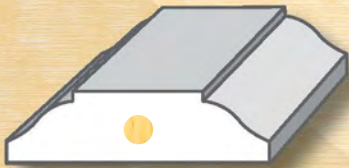

A8173
3/8 x 1-3/8

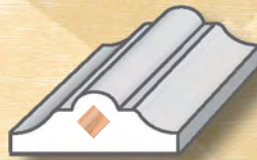

LWM135
3/8 x 7/8

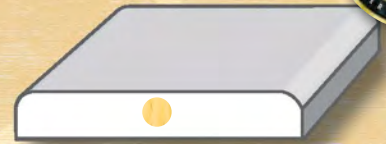

LWM973
1/4 x 1-1/2

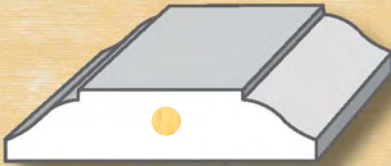

B8173
3/8 x 1-5/8

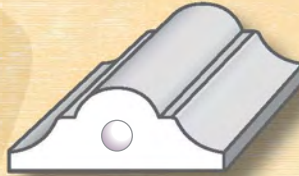

WM130
7/16 x 1-1/8

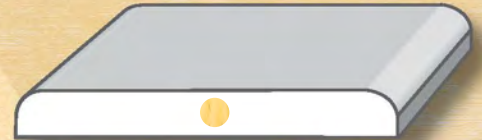

LWM972
1/4 x 2

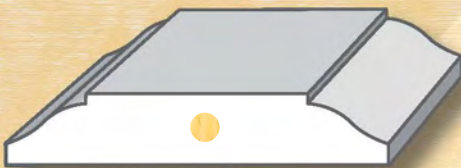

M8753
3/8 x 2

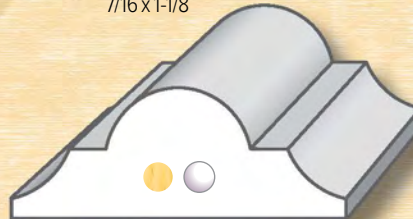

WM133
11/16 x 1-3/4



CSM
3/8 x 2

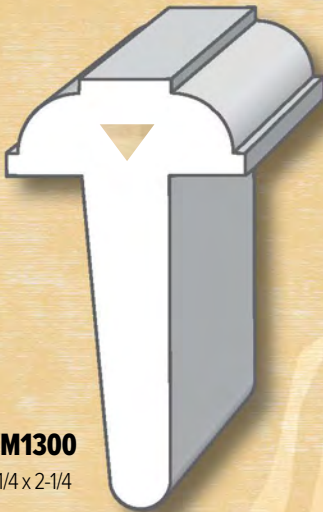

WM1300
1-1/4 x 2-1/4

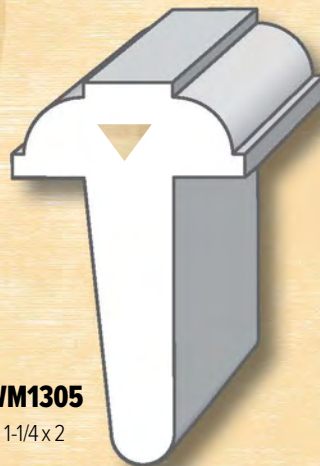

WM1305
1-1/4 x 2

PICTURE FRAME

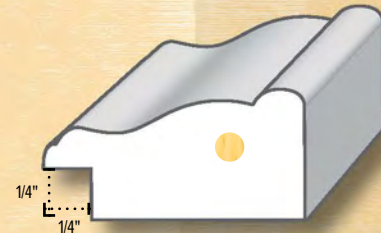

S4
11/16 x 1-3/8

PICTURE MOULDINGS

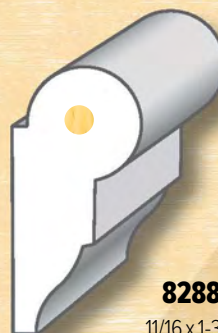

8288
11/16 x 1-3/8

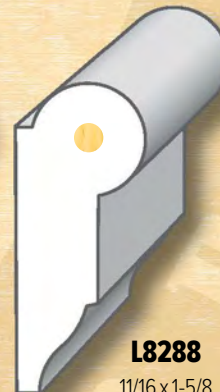

L8288
11/16 x 1-5/8

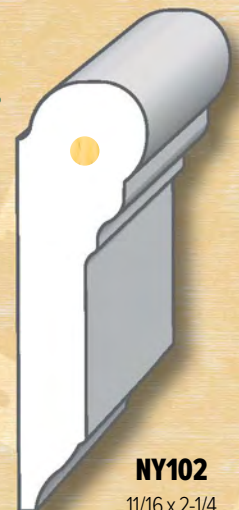

NY102
11/16 x 2-1/4

SKEW BACKS (CHAMFERS)



WP995
3/4 x 3/4





L995
1 x 1

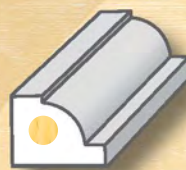
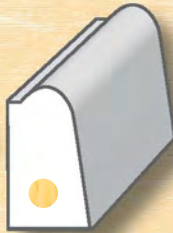

LATTICES

- L8279**
1/4 x 3/4
- 8279**
1/4 x 7/8
- 8280**
1/4 x 1-1/8
- 8281**
1/4 x 1-3/8
- 8282**
1/4 x 1-5/8
- WM265**
1/4 x 1-3/4
- F8282**
1/4 x 2 Full
- G8282**
1/4 x 2-1/4
- L8282**
1/4 x 2-5/8
- L265**
1/4 x 3-1/2
- LWM264**
1/4 x 5-1/4

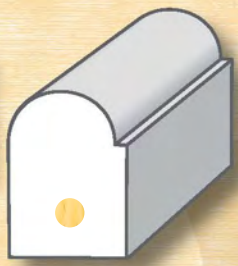
GLASS BEADS

- 
8590
3/8 x 1/2
- 
8565
7/16 x 3/4
- 
B672
3/8 x 7/8
Flat glass Bead
- 
L953
5/8 x 7/8
Sash Bead

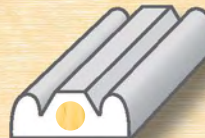
EDGE MOULDINGS

- 
WP140
1/4 x 5/8
Screen Moulding
- 
8611
1/4 x 3/4
Beaded Edge
- 
8610
1/4 x 3/4
Sanitary Edge

PARTING STRIP

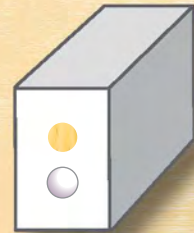
- 
8432
1/2 x 3/4

1/2" X S4S

D5 1/2 x 8 (1/2 x 7-1/4)	D4 1/2 x 6 (1/2 x 5-1/2)	D3 1/2 x 4 (1/2 x 3-1/2)	D2 1/2 x 3 (1/2 x 2-1/2)	D1 1/2 x 2 (1/2 x 1-1/2)
------------------------------------	------------------------------------	------------------------------------	------------------------------------	------------------------------------



STOPS

COLONIAL STOPS

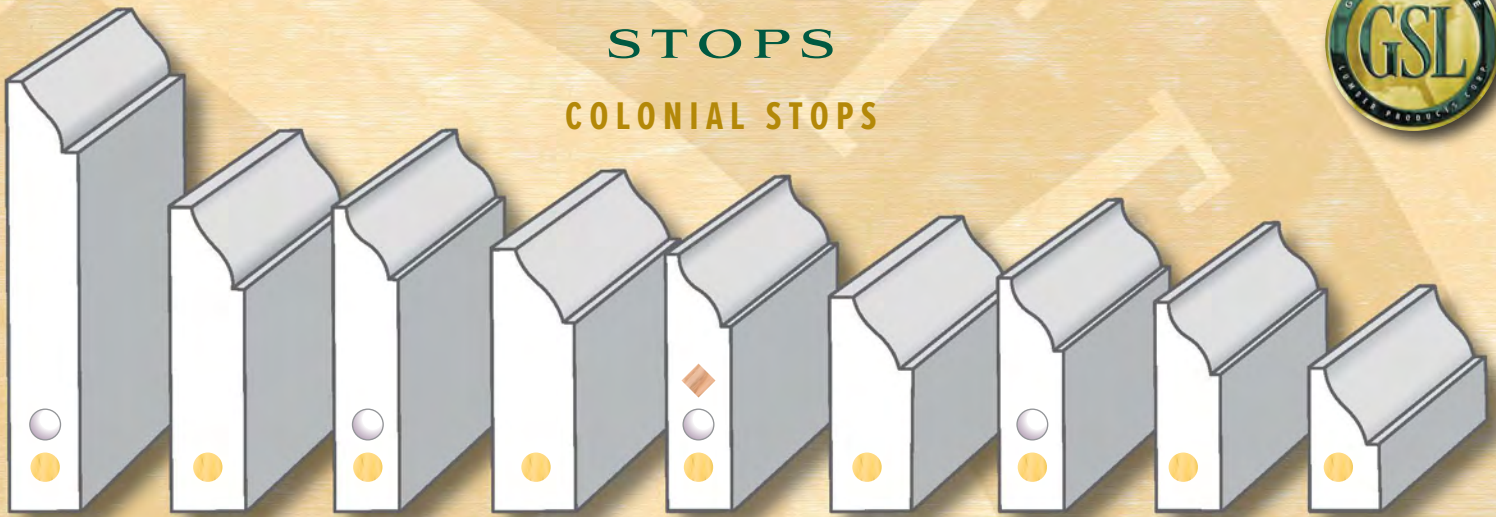

G8090

3/8 x 2-1/4

WM935

7/16 x 1-5/8

E8090

3/8 x 1-5/8

WM936

7/16 x 1-3/8

D8090

3/8 x 1-3/8

WM938

7/16 x 1-1/8

C8090

3/8 x 1-1/8

B8090

3/8 x 7/8

A8090

3/8 x 3/4

CLAM SHELL STOPS

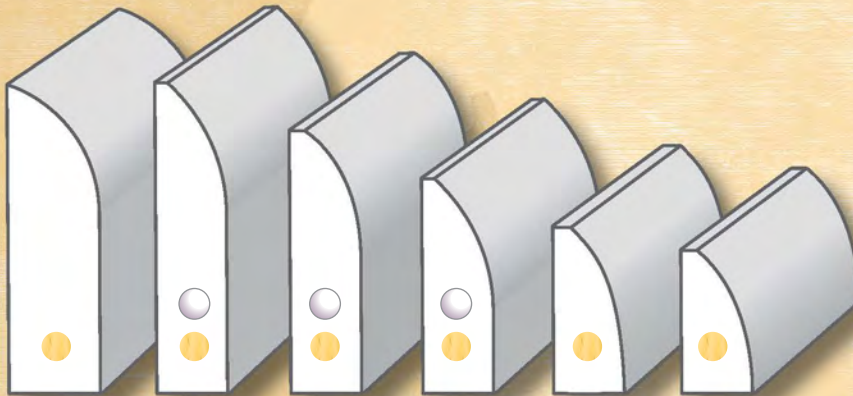

WP845

1/2 x 1-5/8

WP855

3/8 x 1-5/8

WP856

3/8 x 1-3/8

WP858

3/8 x 1-1/8

WP830

3/8 x 7/8

WP831

3/8 x 3/4

EXTERIOR STOPS

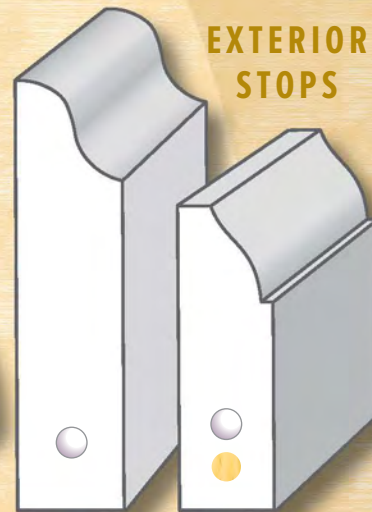

LWM903

9/16 x 2-1/4

WP925

1/2 x 1-5/8

BULLNOSE



8144

11/16 x 1-3/4

BULLNOSE STOPS

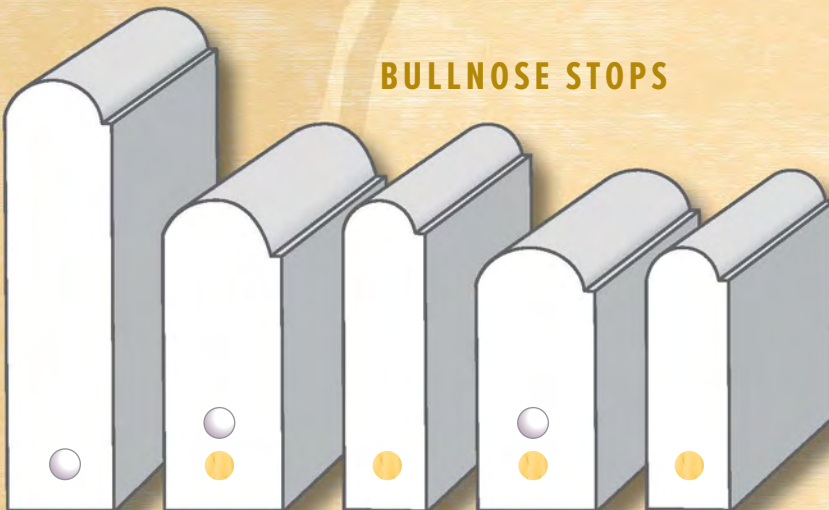

8121

9/16 x 2 1/4

B8121

5/8 x 1-5/8

D8121

7/16 x 1-5/8

A8121

5/8 x 1-3/8

C8121

7/16 x 1-3/8

SANITARY STOPS

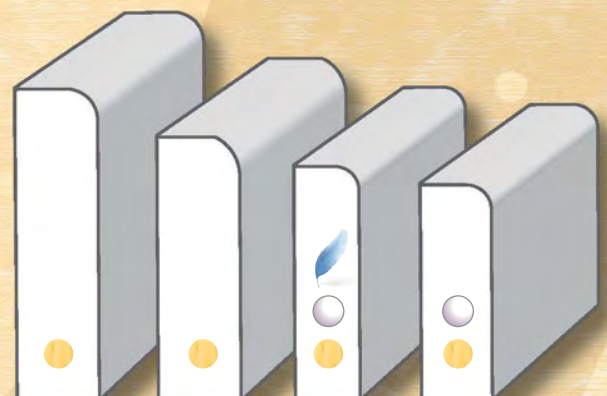

WM875

7/16 x 1-5/8

WM876

7/16 x 1-3/8

WM887

3/8 x 1-1/4

WM888

3/8 x 1-1/8

WWW.GARDENSTATELUMBER.COM

CORNER GUARDS

SANITARY CORNER GUARDS

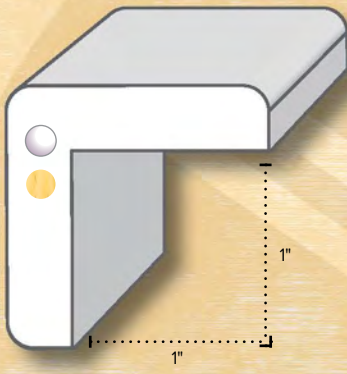

LWM204
1-3/8 x 1-3/8

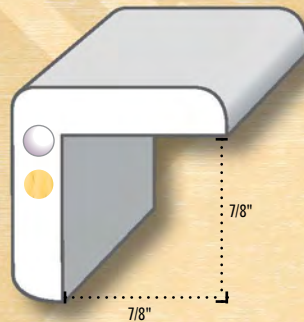

8200
1-1/8 x 1-1/8

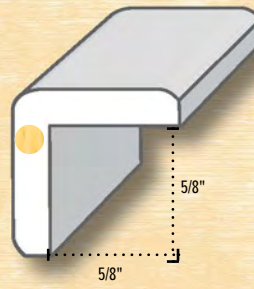

L8200
7/8 x 7/8

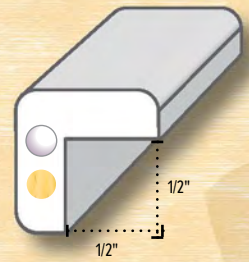

WM206
3/4 x 3/4

COLONIAL CORNER GUARDS

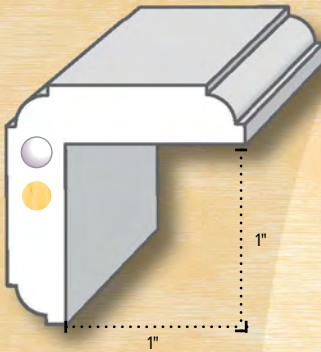

8201
1-3/8 x 1-3/8

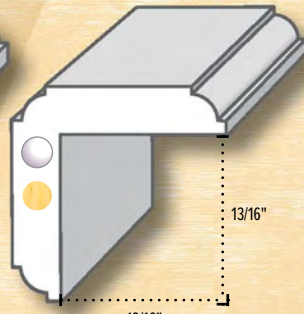

8202
1-1/8 x 1-1/8

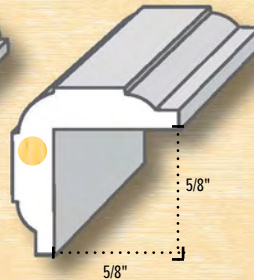

L8202
7/8 x 7/8

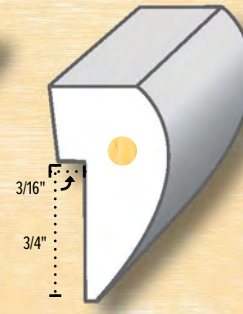

S2
5/8 x 1-1/8

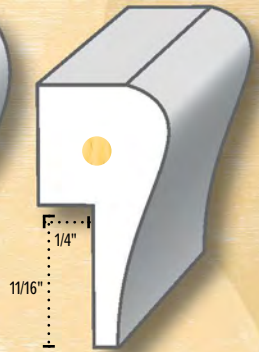

WM290
11/16 x 1-3/8

SANITARY CAPS

DRIP CAPS

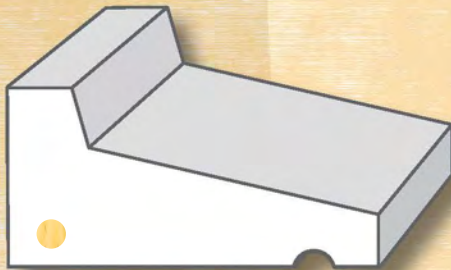

A8926
15/16 x 1-15/16

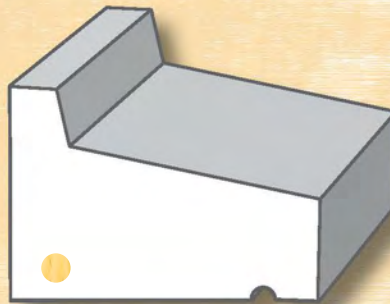

8926
1-1/8 x 1-5/8

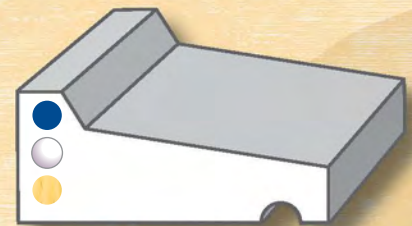

WM197
11/16 x 1-5/8

CHICAGO BAR RAIL

CHIBAR
1-3/4 x 7-1/2





POLES

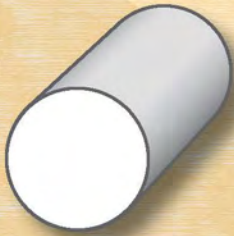

P214 2-1/4 ▽	F8913 1-5/8 ▽	F233 1-5/16 ▽
F8912 1-3/8 ▽	F8911 1-1/8 ▽	8908 3/4 ▽

HALF ROUNDS

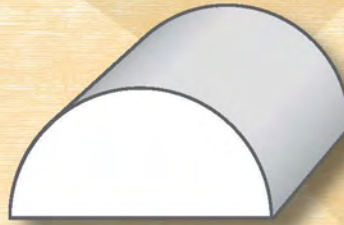

L8080 1-1/8 x 2-1/4 ▽	8080 11/16 x 1-5/8 ●	8073 11/16 x 1-3/8 ●	8072 9/16 x 1-1/8 ●
8071 7/16 x 7/8 ●	8077 3/8 x 3/4 ●	8076 5/16 x 5/8 ●	8070 1/4 x 1/2 ●

QUARTER ROUNDS

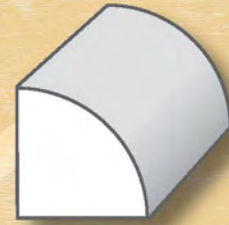

8068 1-1/8 x 1-1/8 ●	8066 7/8 x 7/8 ●	8065 3/4 x 3/4 ● ● ● ●	L8065 11/16 x 11/16 ● ●
8064 5/8 x 5/8 ●	8063 1/2 x 1/2 ● ● ●	8058 3/8 x 3/8 ●	8057 1/4 x 1/4 ●

ROPE

POPLAR

RP12
1/2

RP34
3/4



HAND RAIL KEYHOLE

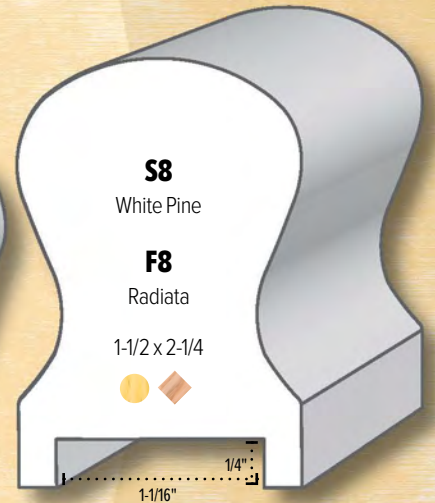

OVAL HAND RAIL

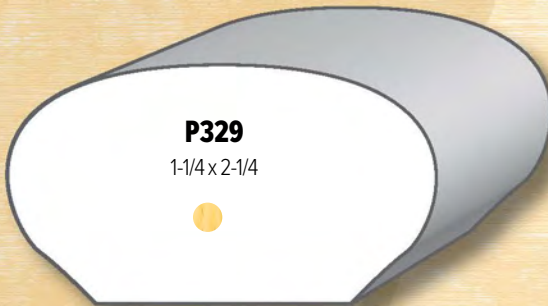

HAND RAIL

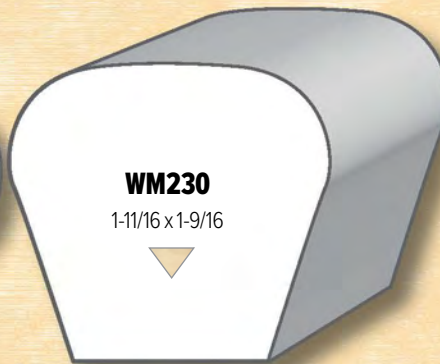

PORCH RAIL (TOP)

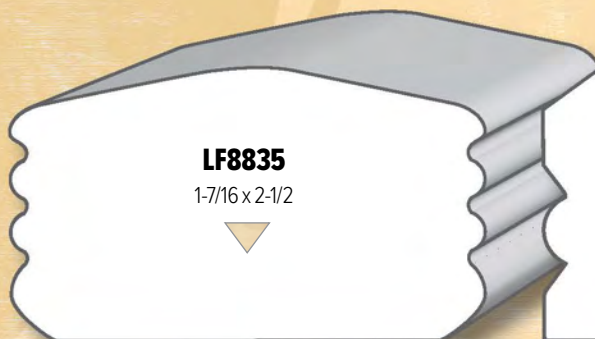

PORCH RAIL (BOTTOM)

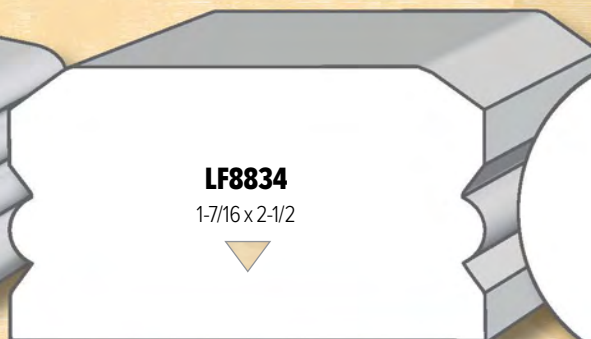

FLAT BOTTOM RAIL

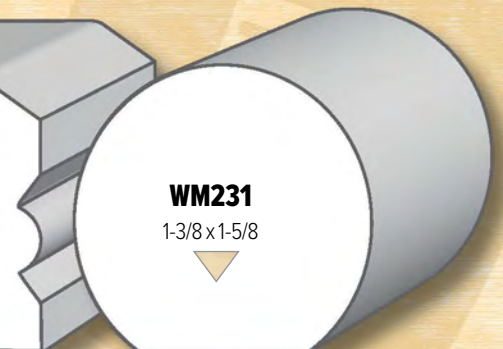

EXTENSION JAMBS

CASEMENT

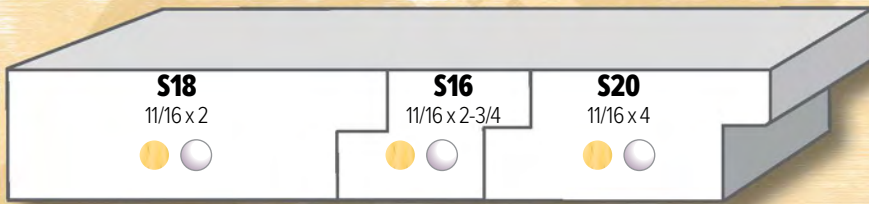

See PVC section for
PVC Sills and other
PVC profiles

NARROWLINE

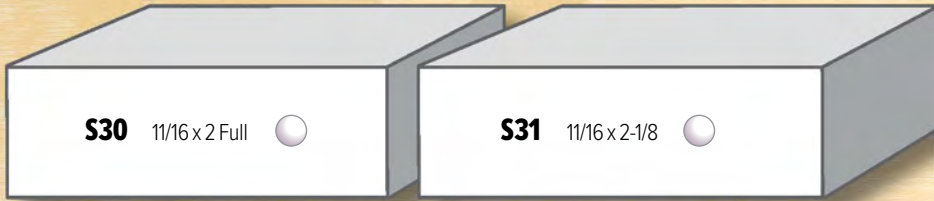

TILT WASH

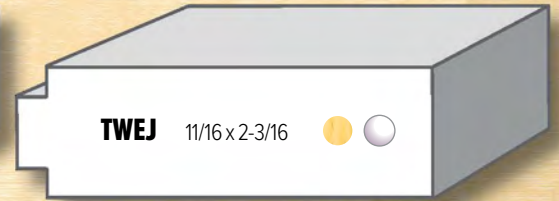

NARROWLINE

STOOLS

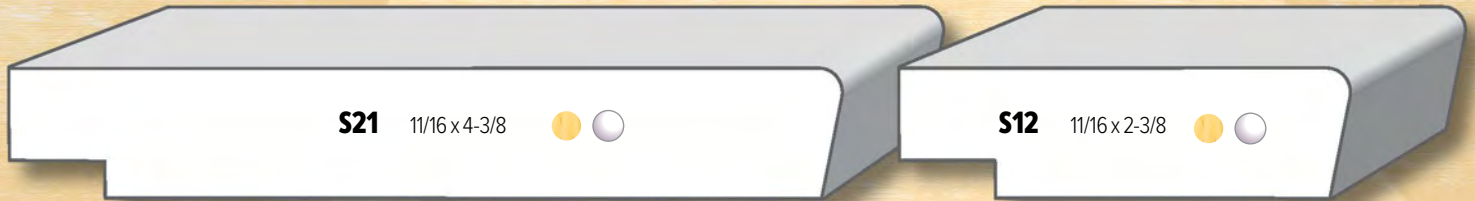

TILT WASH

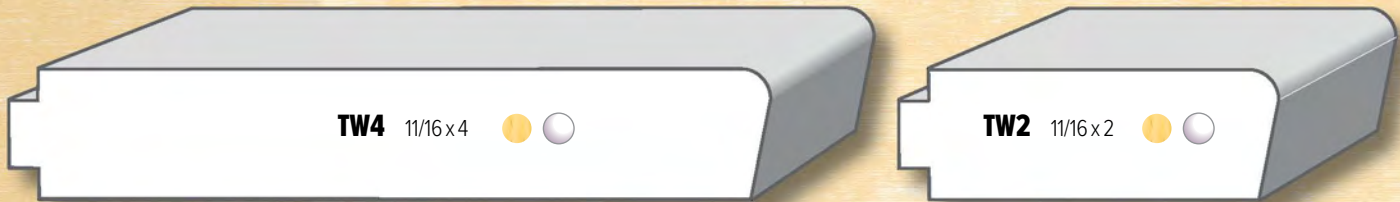

200 SERIES

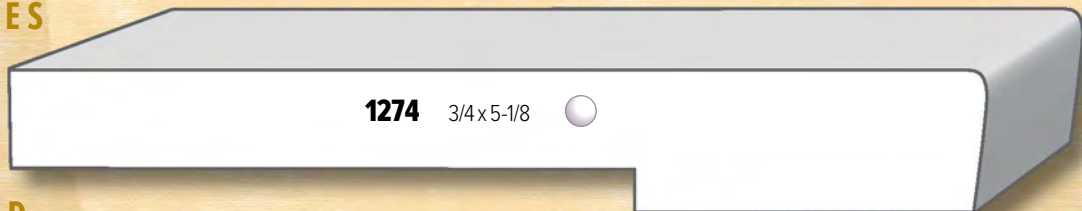

RABETTED

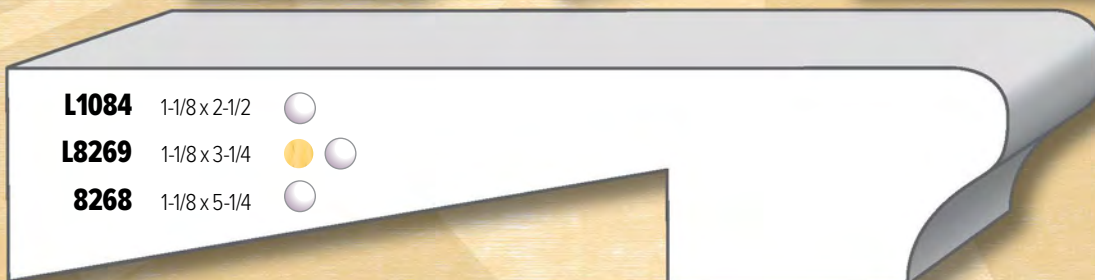
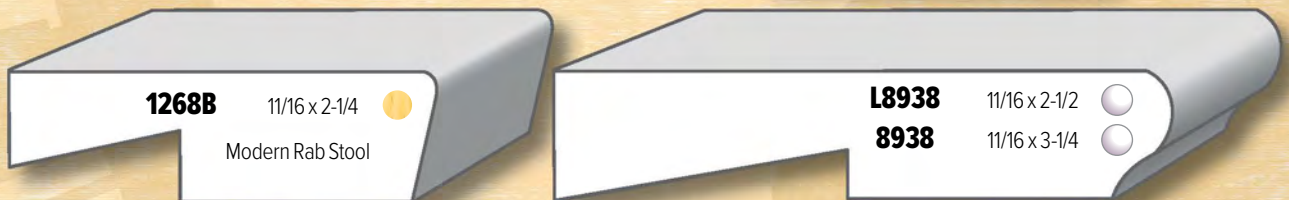

STOOLS



FLAT STOOLS

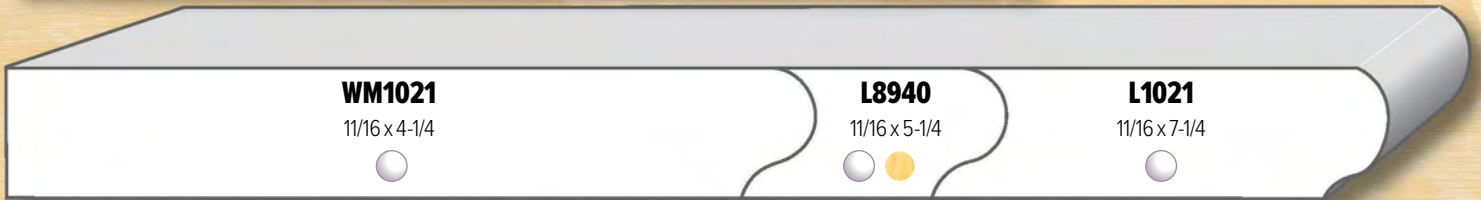
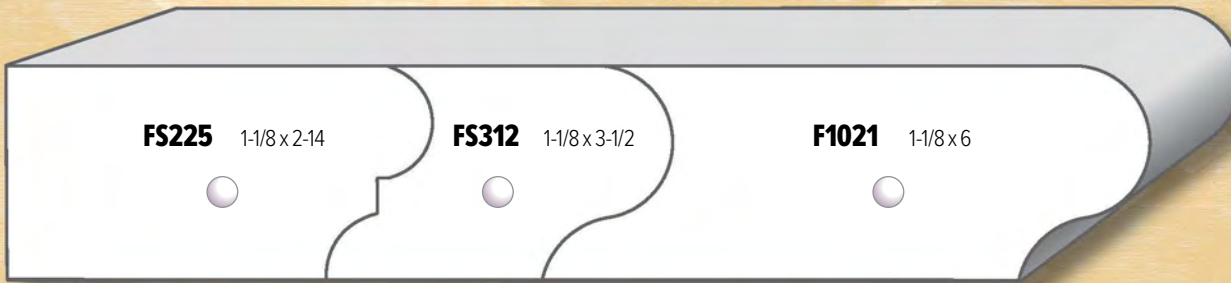

CASEMENT STOOLS



BULLNOSE

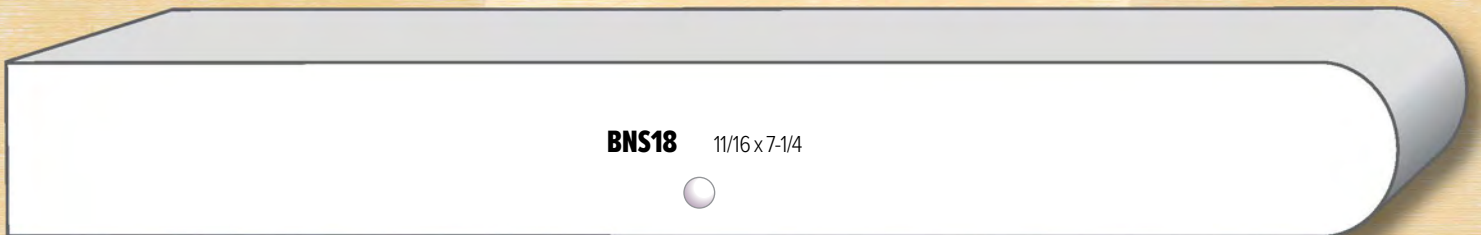

DOOR SILLS

SILLS

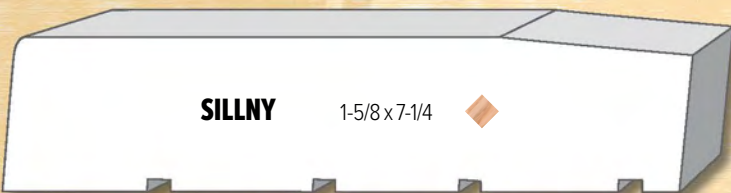

profile shown at 50%

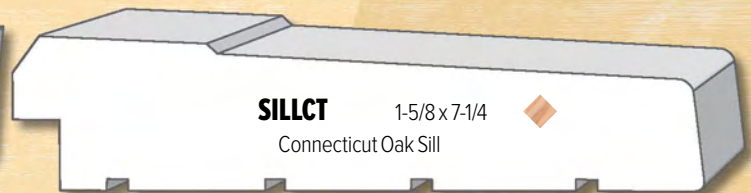

profile shown at 50%

WINDOW SILLS

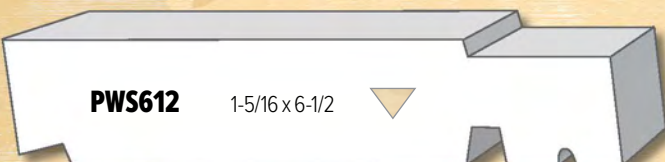

profile shown at 50%



profile shown at 50%

WWW.GARDENSTATELUMBER.COM

MANTEL

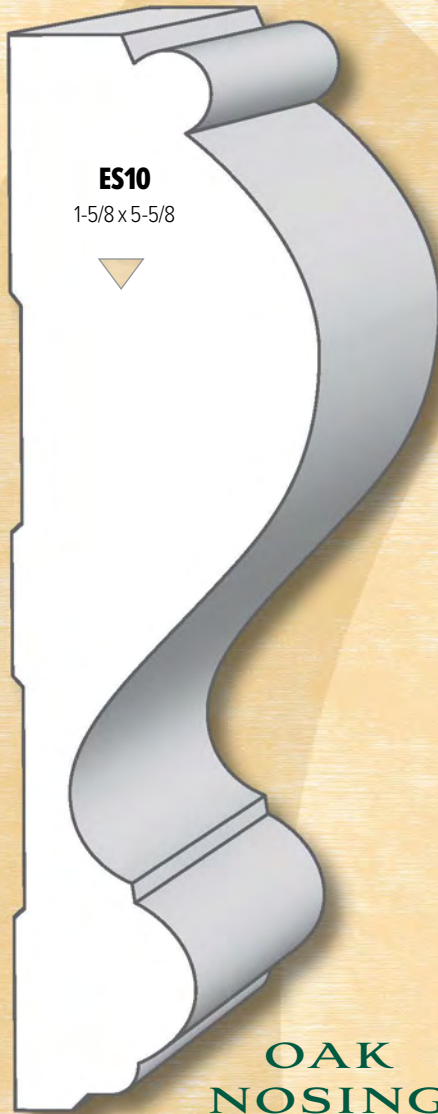

OAK NOSING

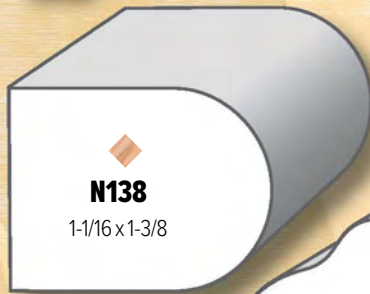

OAK HEARTH BORDER

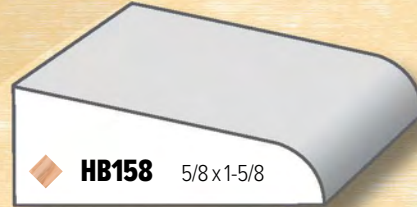

CEDAR CLOSET LINING



LANDING TREADS

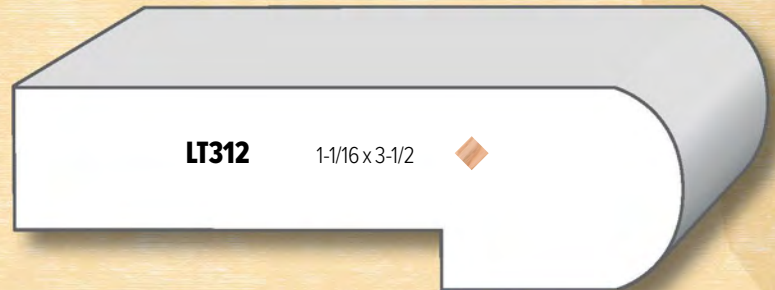

OAK SADDLES

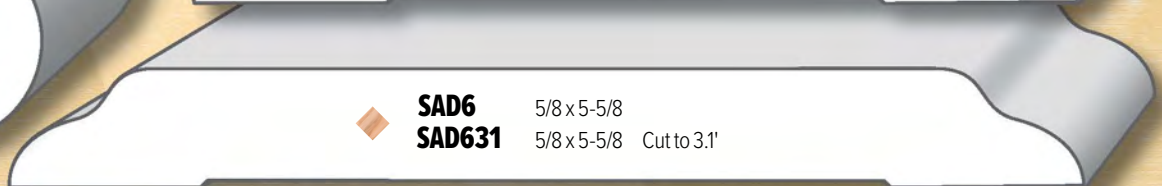
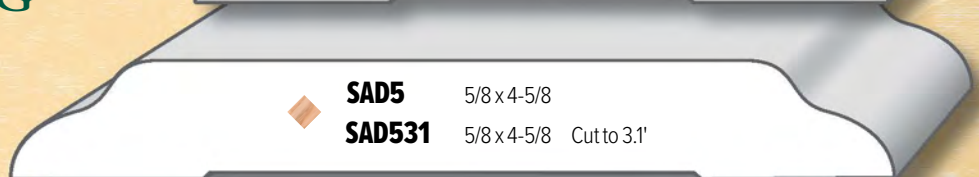
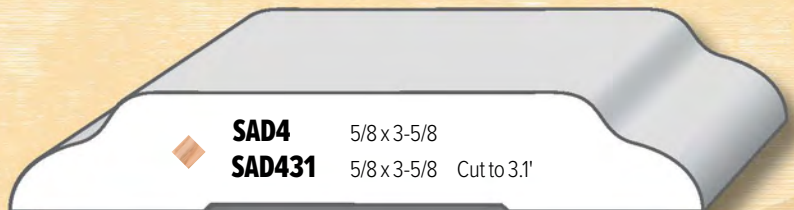

STEPPING

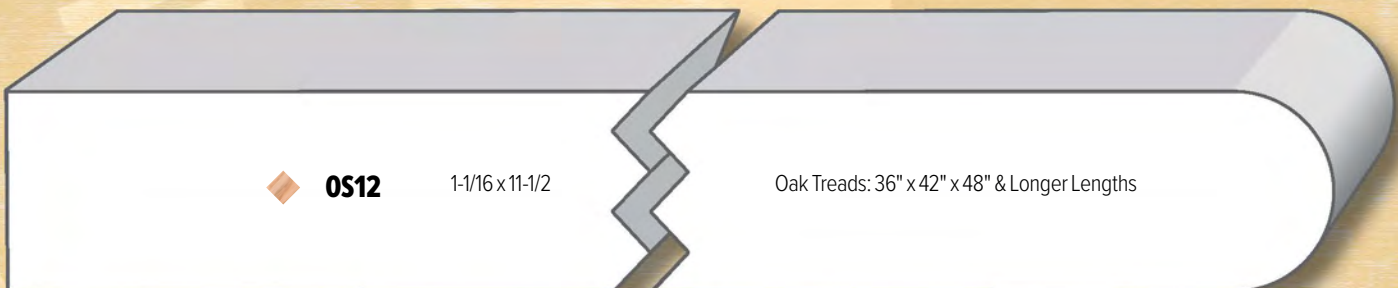

YELLOW PINE T&G FLOORING

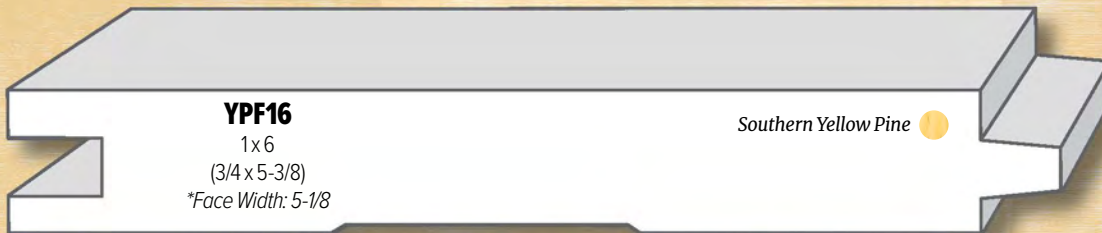
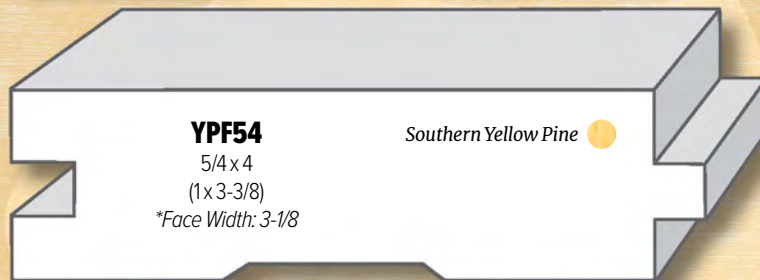
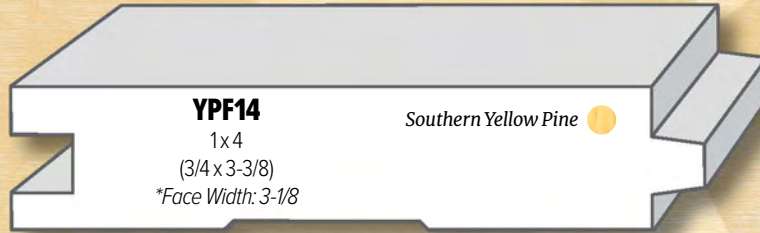
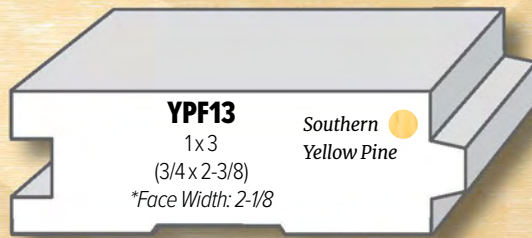

YELLOW PINE SIDING

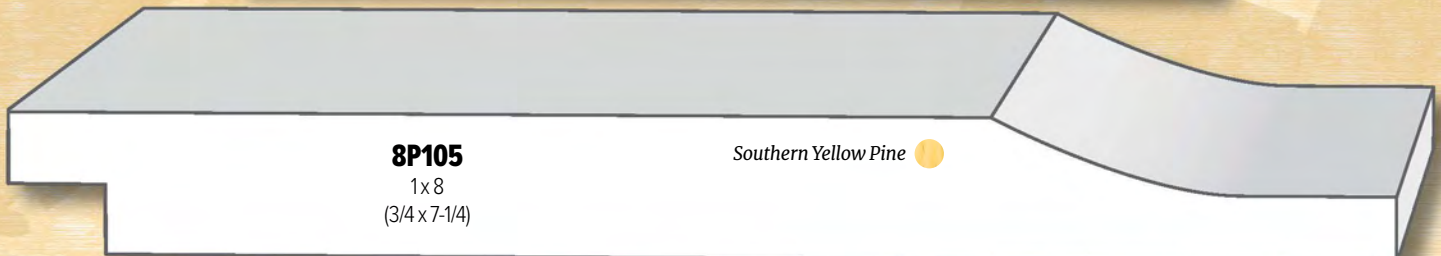
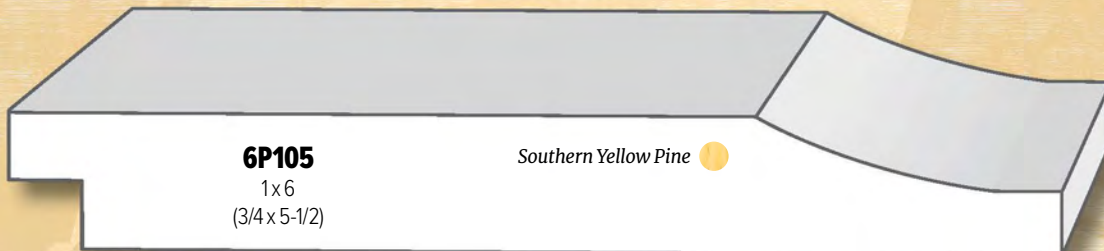

WWW.GARDENSTATELUMBER.COM

**T&G
NICKEL GAP**

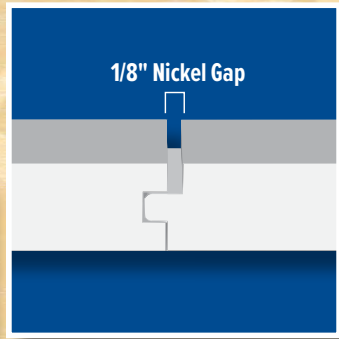

**T&G
V-GROOVE**

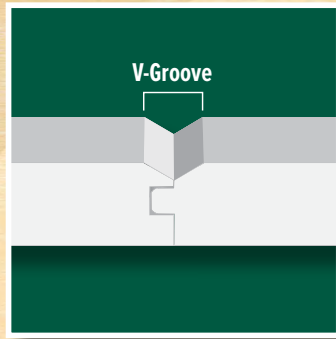

**T&G NICKEL
GAP/V-GROOVE**

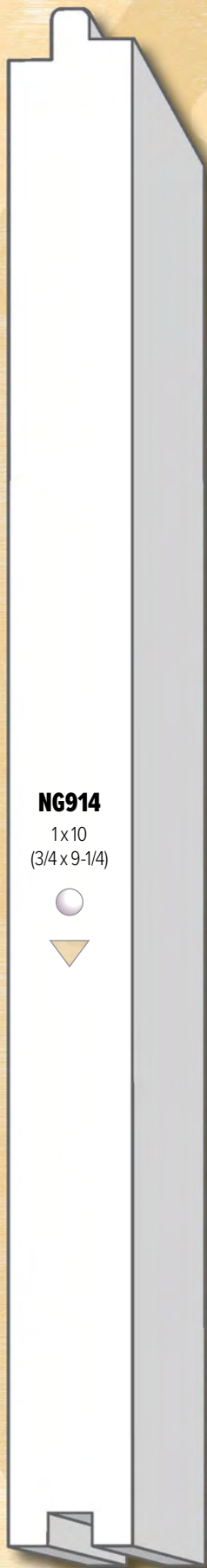
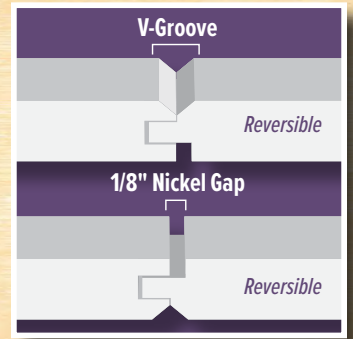

NG914
1x10
(3/4 x 9-1/4)

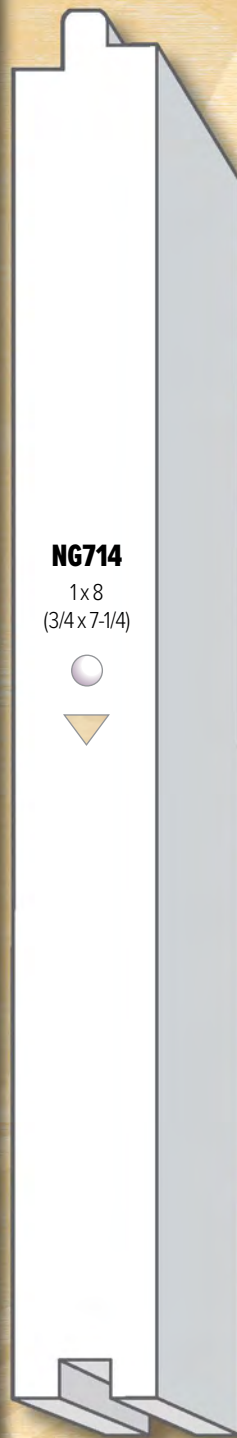
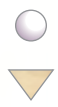

NG714
1x8
(3/4 x 7-1/4)

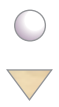

NG512
1x6
(3/4 x 5-1/2)

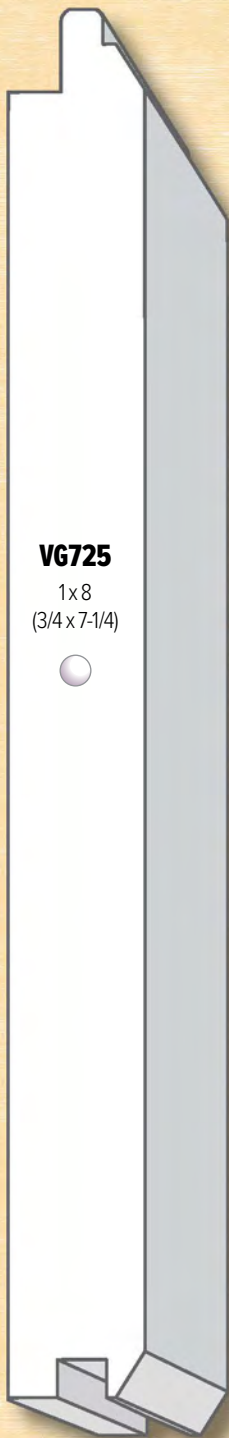
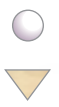

VG725
1x8
(3/4 x 7-1/4)



NVG514
9/16 x 5-1/4
Reversible

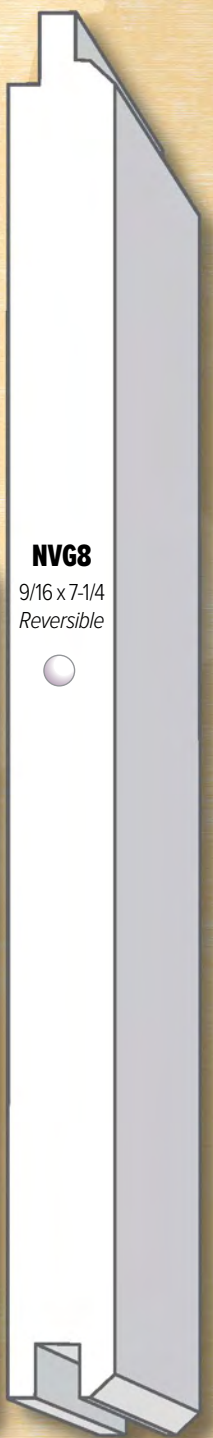

NVG8
9/16 x 7-1/4
Reversible





1

1

2

3

4

5

7

6

- 1 **DC450**
- 2 **PWS634 (SILL)**
- 3 **SC214 (APRON)**
- 4 **5/4x3"**
- 5 **NG914**
- 6 **OS12**
- 7 **DCB8**

SHIPLAP

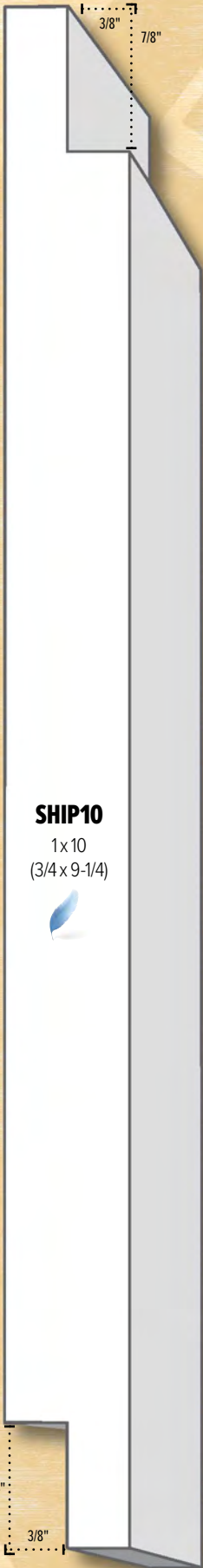

SHIP10

1x10
(3/4 x 9-1/4)

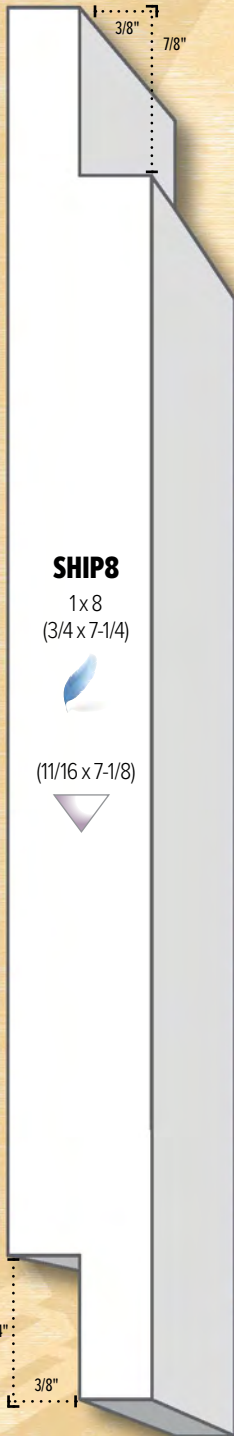
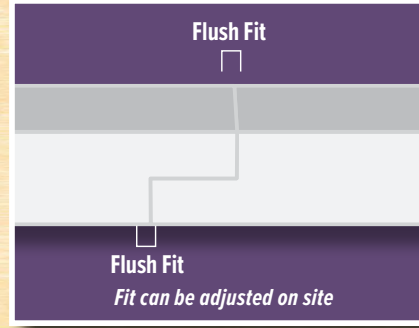
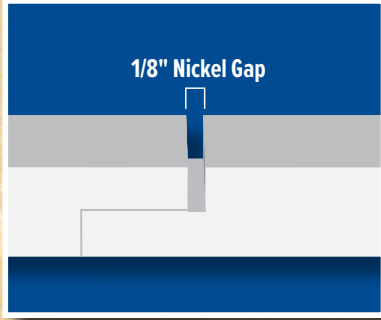

SHIP8

1x8
(3/4 x 7-1/4)



(11/16 x 7-1/8)

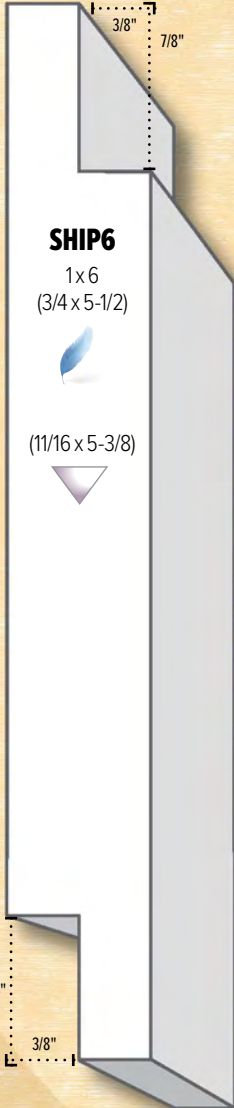

SHIP6

1x6
(3/4 x 5-1/2)



(11/16 x 5-3/8)

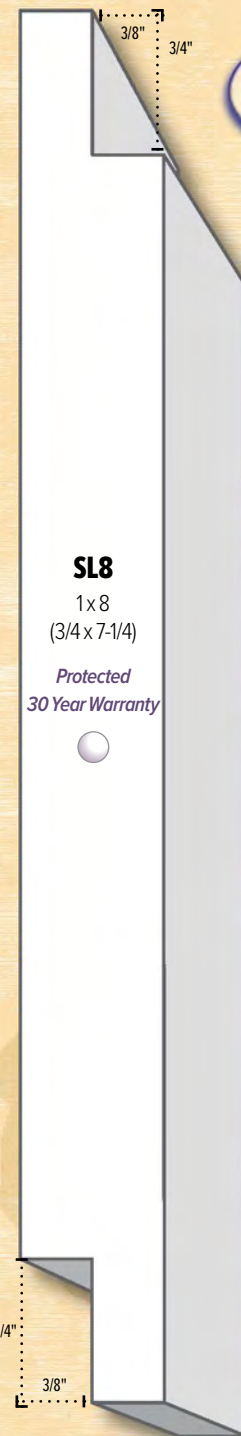

SL8

1x8
(3/4 x 7-1/4)

Protected
30 Year Warranty



SL6

1x6
(3/4 x 5-1/2)

Protected
30 Year Warranty



SL8 & SL6:
Smooth One Side,
Rough Sawn One Side



PINE



PRIMED PINE



PRIMED POPLAR



POPLAR



PRIMED MDF



RED OAK



WHITE OAK



PVC



- 1 SHIP10
- 2 WM47
- 3 SHIP6
- 4 ES12
- 5 WM97
- 6 LS6
- 7 ES9



- 1 SHIP10
- 2 MSC275, 1x3
- 3 SHIP6
- 4 MCC434
- 5 DCR814
- 6 OS12 STEPPING
- 7 MCB712



1

2

3

4

5

6

- 1 SHIP6
- 2 DCR725
- 3 DC550
- 4 DCAS5, D2 S4S
- 5 ECB6
- 6 DCB825

TONGUE & GROOVE EDGE & CENTER BEADS

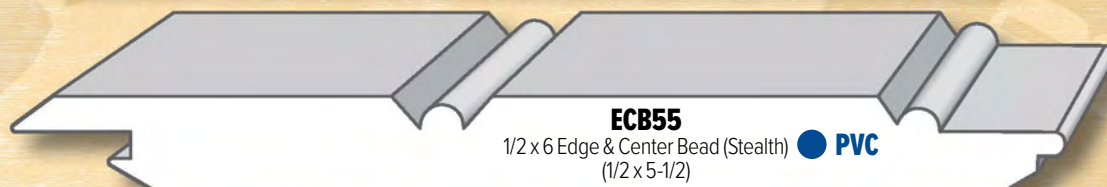
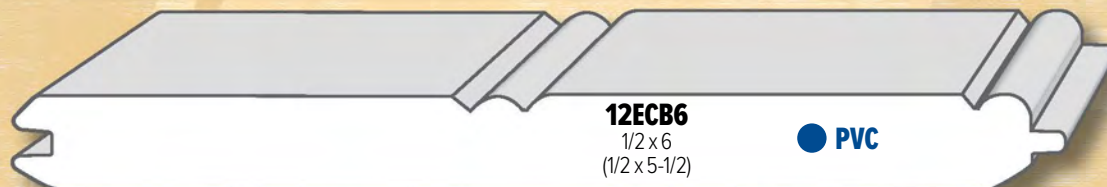
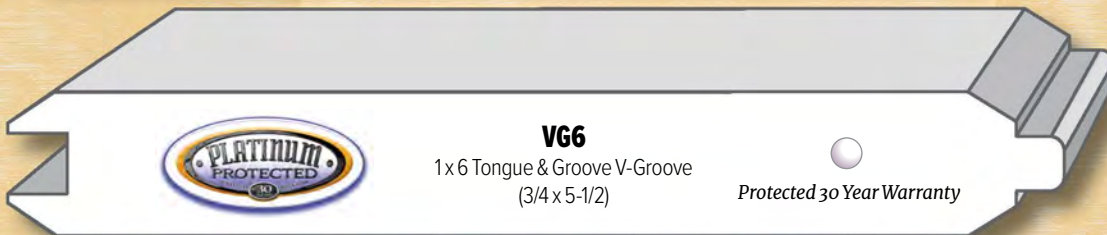
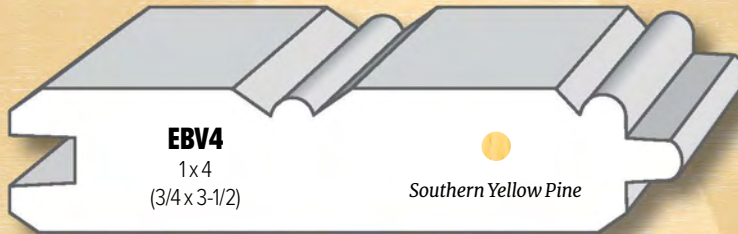
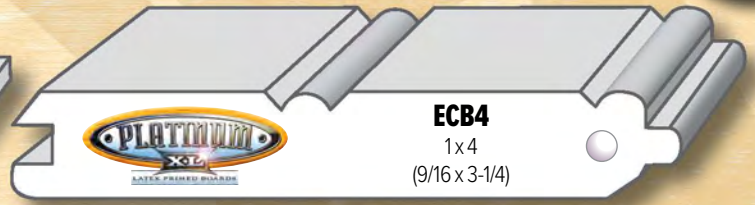

WWW.GARDENSTATELUMBER.COM

3/4" LUG

B
OVERALL
LENGTH

A
BELOW
DADO

DOOR JAMBS

INTERIOR

SKU#	SIZE (DEPTH X WIDTH)	A	B	SPECIES
JL358PRF	11/16" X 3-5/8"	81-1/2"	82-15/16"	●
JL458PRF	11/16" x 4-5/8"	81"	82-7/16"	●
JL458PRF-NL (NO LUG)	11/16" x 4-5/8"	81"	81-11/16"	●
JL491	11/16" x 4-5/8"	81-1/2"	82-15/16"	●
JL491PRF	11/16" x 4-5/8"	81-1/2"	82-15/16"	●
JL491PRF - 7	11/16" x 4-5/8"	85-1/2"	86-15/16"	●
JL491PRF - 8	11/16" x 4-5/8"	97-1/2"	98-15/16"	●
JL478PRF	11/16" x 4-7/8"	81-1/2"	82-15/16"	●
JL478PRF - 7	11/16" x 4-7/8"	85-1/2"	86-15/16"	●
JL478PRF - 8	11/16" x 4-7/8"	97-1/2"	98-15/16"	●
JL538PRF	11/16" x 5-3/8"	81-1/2"	82-15/16"	●
JL691PRF	11/16" x 6-5/8"	81-1/2"	82-15/16"	●
JL691PRF - 8	11/16" x 6-5/8"	97-1/2"	98-15/16"	●
JL678PRF - 8	11/16" x 6-7/8"	97-1/2"	98-15/16"	●

specs (3/4 lug, 5/16 dado depth, 1/32 back bevel)

WWW.GARDENSTATELUMBER.COM

THE METRO

COLLECTION
TIMELESSLY MODERN MOULDINGS



*Coffered Ceiling: MCR714, S4S with MCS1 Shoe
Fire Place Panel Insert: MCAP2 with MSC275, Mantel Trim Piece: MSC175 Crown
Base: MCB712 with MCS1 Shoe, Casing: MCC312 with MCBB2, Apron: MCC212*

CASINGS



MCC534
1-3/8" x 5-3/4"



MCC434
1-3/8" x 4-3/4"



MCC334
1-1/8" x 3-3/4"





MCC334 Casing

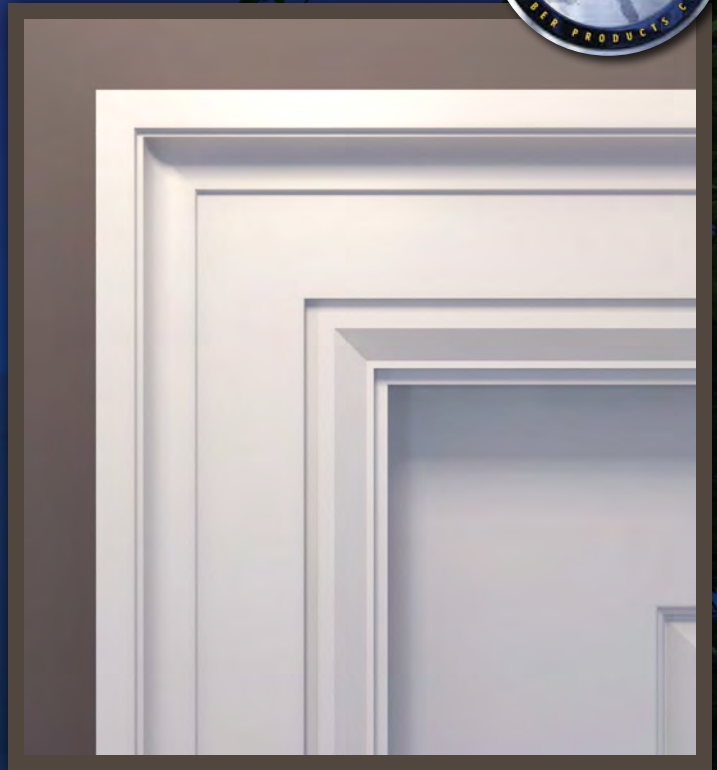

MCC434 Casing

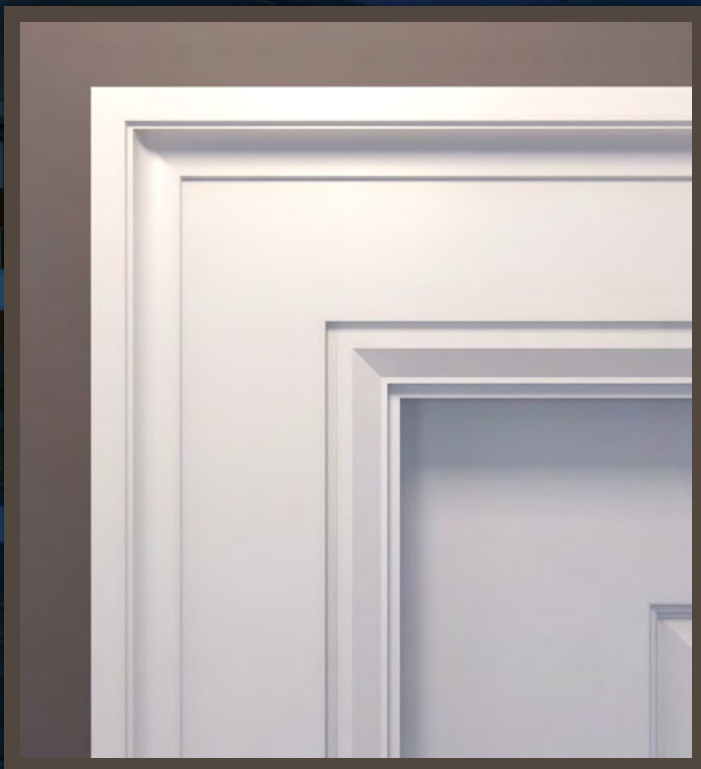

MCC534 Casing



MCC434 Used as Chair Rail

CASINGS



MCC575
1-3/8" x 5-3/4"



MCC475
1-3/8" x 4-3/4"



MCC375
1-1/8" x 3-3/4"



MCC375 Casing



MCC475 Casing



MCC575 Casing



MCC475 Used as Chair Rail

BACK BANDS

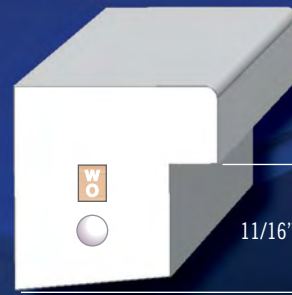

MCBB1
1-1/16" x 1-1/16"

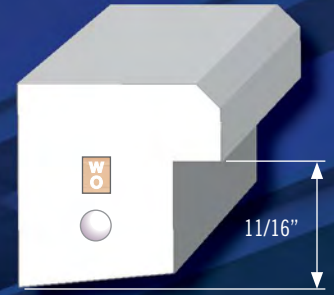

MCBB2
1-1/16" x 1-1/16"

CASINGS



MCC412
11/16" x 4-1/2"

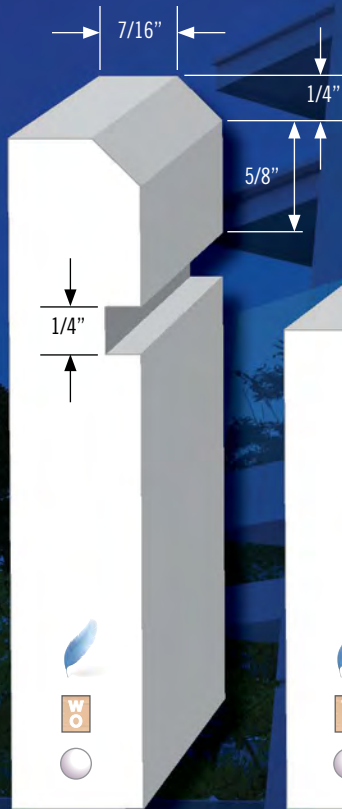

MCC312
11/16" x 3-1/2"



MCC212
11/16" x 2-1/2"



SCOOP35
13/16" x 3-1/2"



STEP35
13/16" x 3-1/2"



*MCC312 Casing, MCBB1 Back Band,
LS6 Sill, MCC212 Apron*

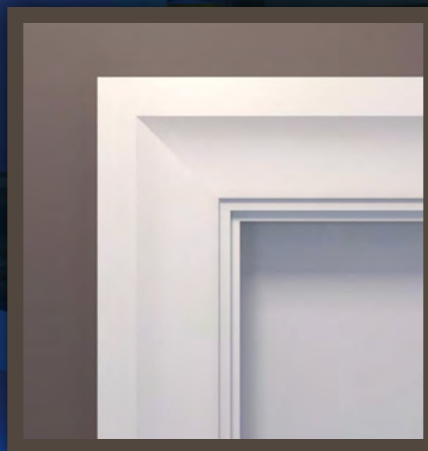

SCOOP35



STEP35

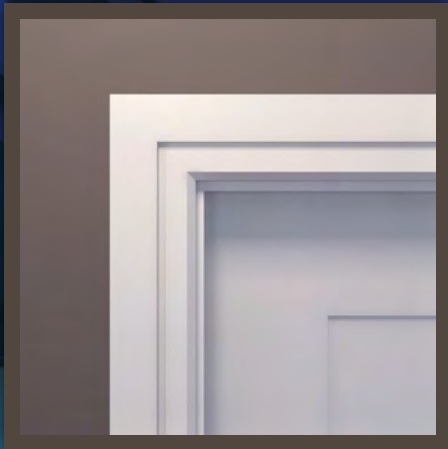

MCC212 Casing

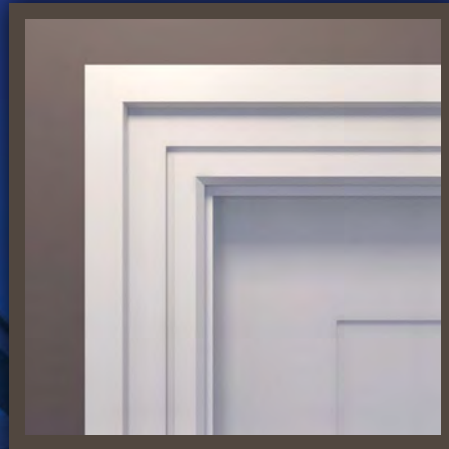

MCC212 Casing & MCBB1 Back Band



MCC212 Casing & MCBB2 Back Band

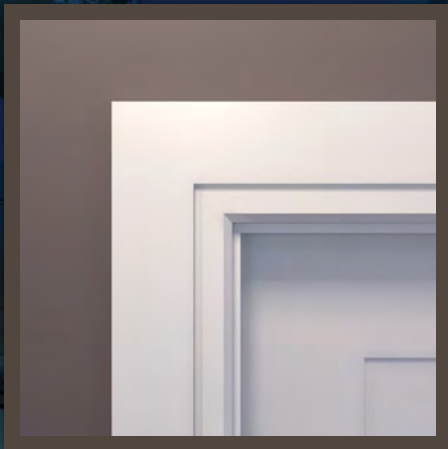

MCC312 Casing

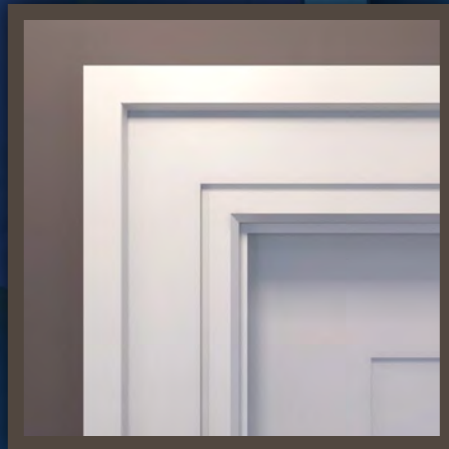

MCC312 Casing & MCBB1 Back Band

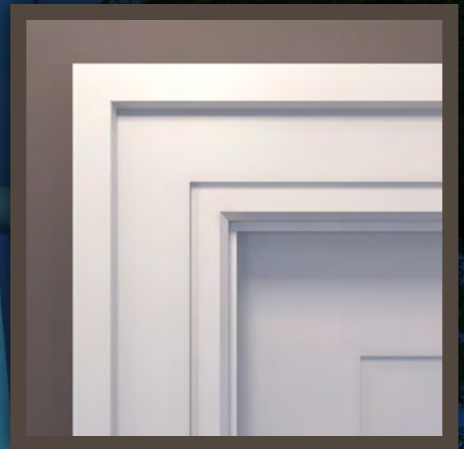

MCC312 Casing & MCBB2 Back Band

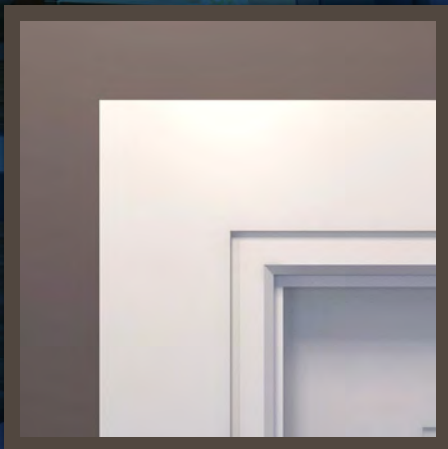

MCC412 Casing

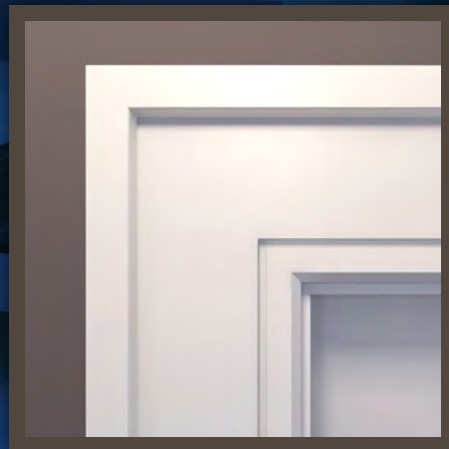

MCC412 Casing & MCBB1 Back Band

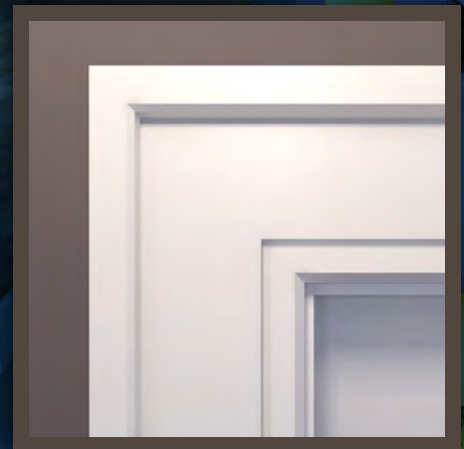

MCC412 Casing & MCBB2 Back Band

CHAIR RAILS

MCC475



MCC475 Used as Chair Rail

MCC334



MCC334 Used as Chair Rail

MCAP1

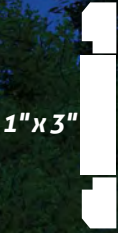

1" x 3"

MCAP1



MCAP1 with 1" x 3"

MCAP2

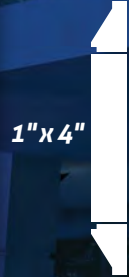

1" x 4"

MCAP2



MCAP2 with 1" x 4"

MSC175

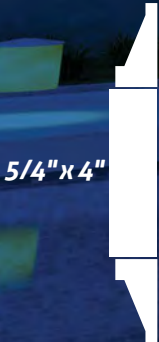

5/4" x 4"

MSC175



MSC175 with 5/4" x 4"

1" x 2"



MSC275

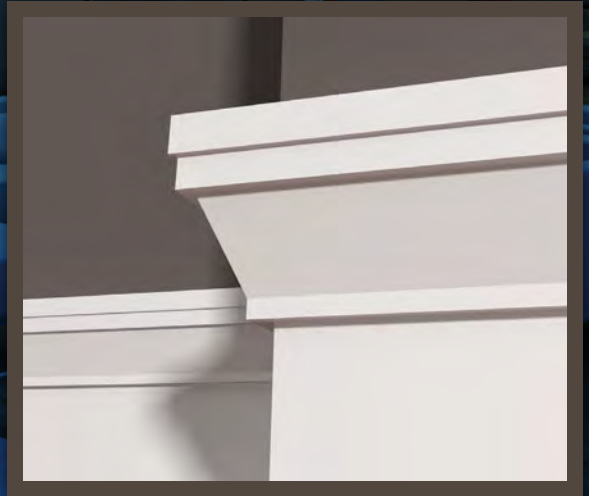

MSC275 with 1" x 2"





BASES



MCB525 Base

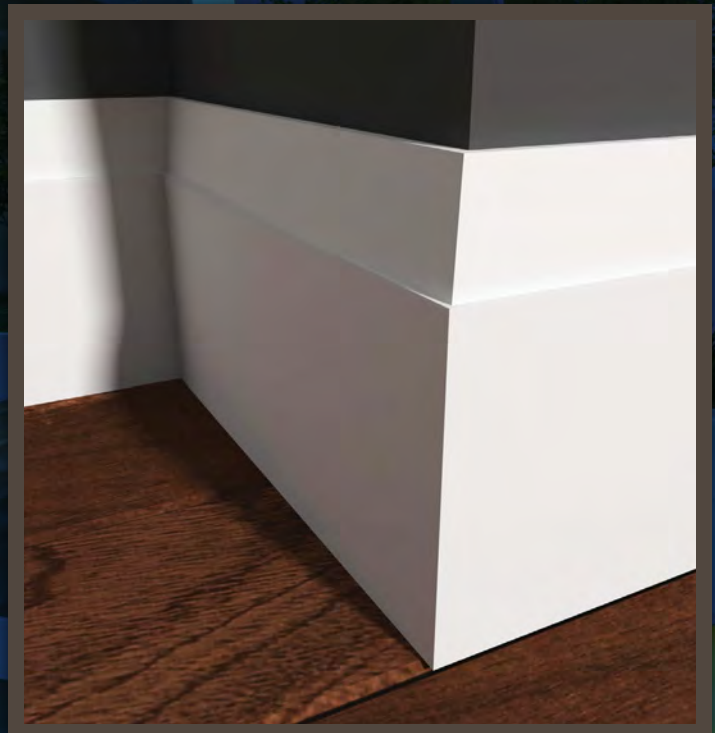

MCB725 Base

MCB725

9/16" x 7-1/4"

MCB525

9/16" x 5-1/4"

BASES



MCB712
9/16" x 7-1/2"



MCB512
9/16" x 5-1/2"



MCB7
11/16" x 7"



MCB5
11/16" x 5"



MCS1
5/8" x 1"



MCB512 Base, MCS1 Shoe



MCB712 Base, MCS1 Shoe



MCB5 Base



MCB7 Base, MCS1 Shoe

BASES



STEP7
11/16" x 7"



STEP55
11/16" x 5-1/2"



SCOOP7
11/16" x 7"



SCOOP55
11/16" x 5-1/2"





SCOP55 Base



STEP55 Base



SCOP7 Base



STEP7 Base

CAPS & S4S

USED IN BASE APPLICATIONS

Add our Metro Caps & Panels to our S4S for an endless array of design details



PLATINUM XL = **XL**



30 YEAR WARRANTY

PLATINUM PROTECTED = **XLP**

1/2 x S4S:

1/2 x 2 (1/2 x 1-1/2)	XL
1/2 x 3 (1/2 x 2-1/2)	XL
1/2 x 4 (1/2 x 3-1/2)	XL
1/2 x 6 (1/2 x 5-1/2)	XL
1/2 x 8 (1/2 x 7-1/4)	XL

1 x S4S:

1 x 2 (3/4 x 1-1/2)	XL
1 x 3 (3/4 x 2-1/2)	XL XLP
1 x 4 (3/4 x 3-1/2)	XL XLP
1 x 5 (3/4 x 4-1/2)	XL XLP
1 x 6 (3/4 x 5-1/2)	XL XLP
1 x 8 (3/4 x 7-1/4)	XL XLP
1 x 10 (3/4 x 9-1/4)	XL XLP
1 x 12 (3/4 x 11-1/4)	XL XLP

5/4 x S4S:

5/4 x 4 (1-1/8 x 3-1/2)	XL XLP
5/4 x 6 (1-1/8 x 5-1/2)	XL XLP
5/4 x 8 (1-1/8 x 7-1/4)	XL XLP
5/4 x 10 (1-1/8 x 9-1/4)	XL XLP
5/4 x 12 (1-1/8 x 11-1/4)	XL XLP

V-GROOVE:

1 x 6 (3/4 x 5-1/2)	XLP
---------------------	------------

EDGE & CENTER BEADS:

1 x 4 ECB (9/16 x 3-1/2)	XL
1 x 6 ECB (3/4 x 5-1/2)	XL XLP

SHIPLAP:

1 x 6 (3/4 x 5-1/2)	XLP
1 x 8 (3/4 x 7-1/4)	XLP



MCAP34 Cap, 1" x 6", MCS1 Shoe Moulding

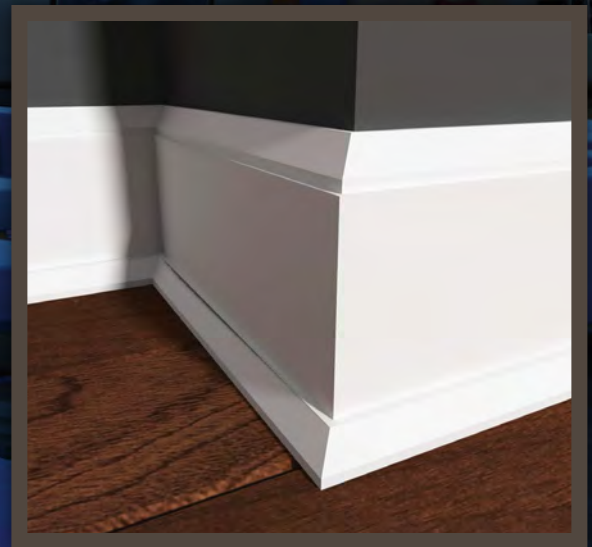

MCS1 Shoe used as cap, 1" x 6", MCS1 Shoe





PANELS & CAPS



MSC175
7/8" x 1-3/4"



MCAP54
1" x 1-3/4"



MCAP34
5/8" x 1-3/4"



MCAP1
3/4" x 1-1/16"



MCAP2
3/4" x 1-1/16"

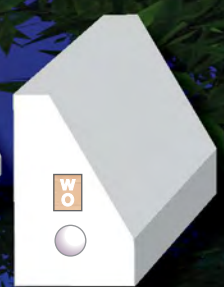

MCS1
5/8" x 1"



MSC175 as cap, 1" x 8", 1/2" x 2" as Shoe Moulding



MCAP2 Cap, 1" x 6", MCS1 Shoe Moulding



MCAP1 Cap, 1" x 8", MCS1 Shoe Moulding

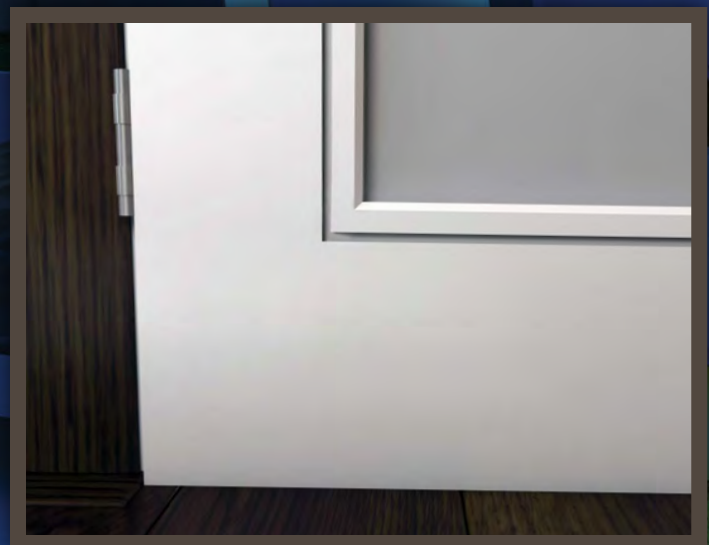

Casing: MCAP1 on 1x5, Base: MCAP1 on 1x8

EASED EDGE PROFILES
CASINGS



WM412
11/16" x 3-1/2"



E2E432
9/16" x 3-1/2"



WM452
11/16" x 2-1/2"



WM472
9/16" x 2-1/2"



*Base, Panel & Cap: SAN525 Base, SB6MG Modern Groove, MSC175 Solid Crown, B8121
Window: MCC312 Casing, MCBB2 Back Band, LS6 Stool, MSC175 Solid Crown*



EASED EDGE PROFILES BASES

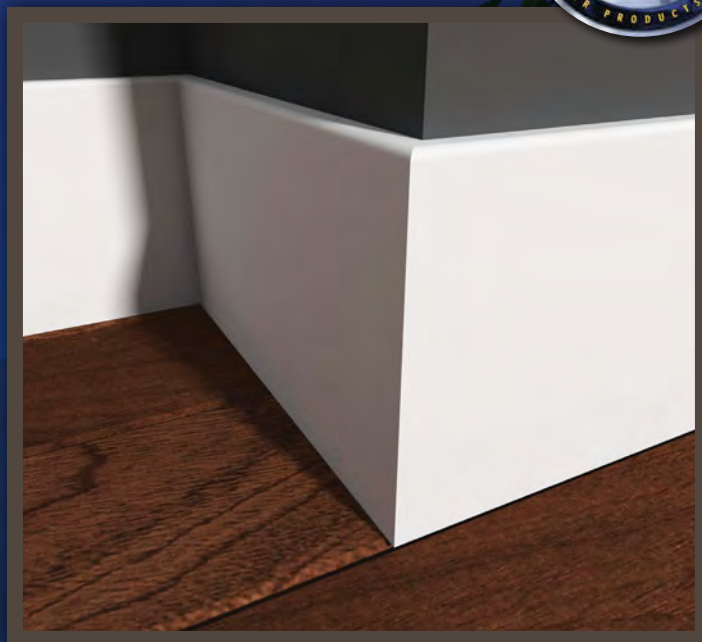

SAN725 Base



SAN725
9/16" x 7-1/4"



SAN525
9/16" x 5-1/4"



SAN414
9/16" x 4-1/4"



LWM412
11/16" x 3-1/2"



LWM432
9/16" x 3-1/2"

SOLID CROWNS



MSC275
1-3/8" x 2-3/4"



MSC225
1-1/8" x 2-1/4"

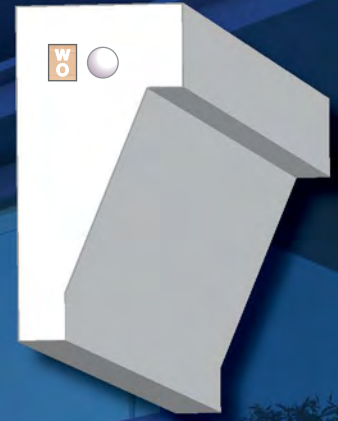

MSC175
7/8" x 1-3/4"



Cap: MSC175 Solid Crown, B8121
Window: MCC312 Casing, MCBB2 Back Band, LS6 Stool, MSC175 Apron

MODERN HEADER DETAIL



MSC275



5/4" x 6"

MCS1

MCC412



SAN414

MCOV5

MSC175

MCC412
& MCBB2



1" x 8"

WM887



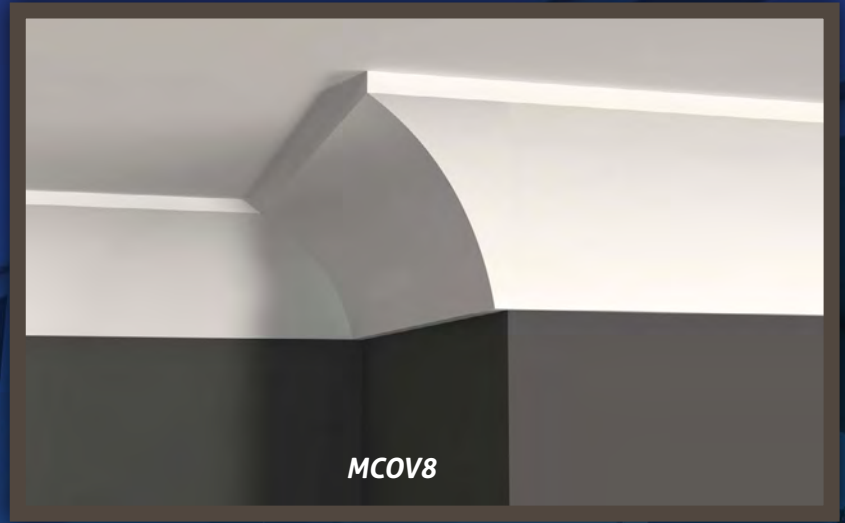

MCOV8



MCOV8

1-1/8" x 7-1/4"

Projection: 5-1/16" Height: 5-1/16"



MCOV6

1-1/8" x 5-1/4"

Projection: 3-5/8" Height: 3-5/8"



MCOV5

3/4" x 4-1/4"

Projection: 3" Height: 3"



COVE BUILD UPS

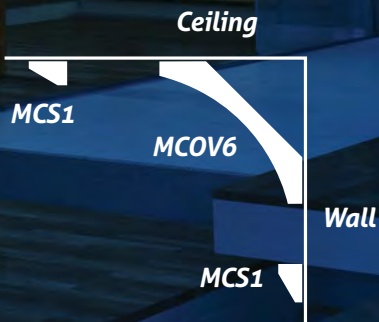
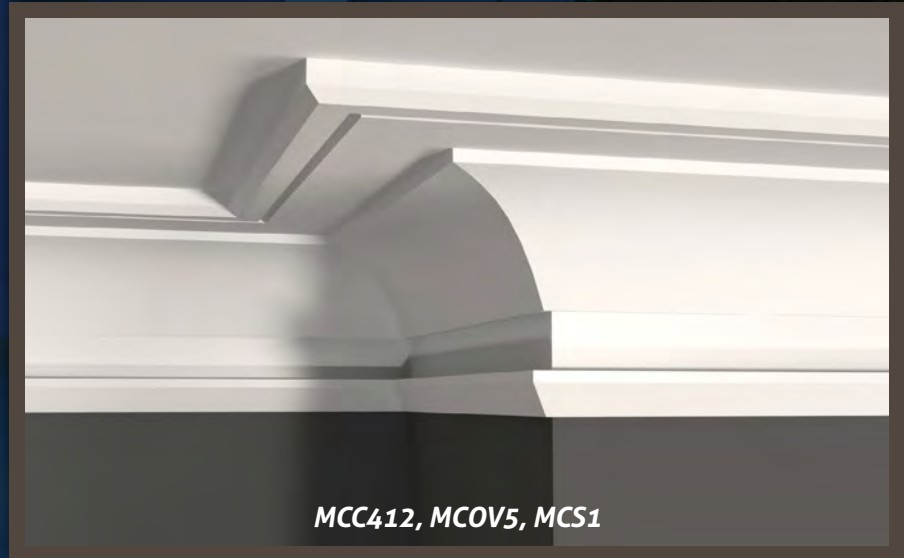
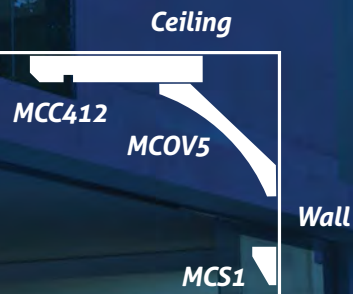
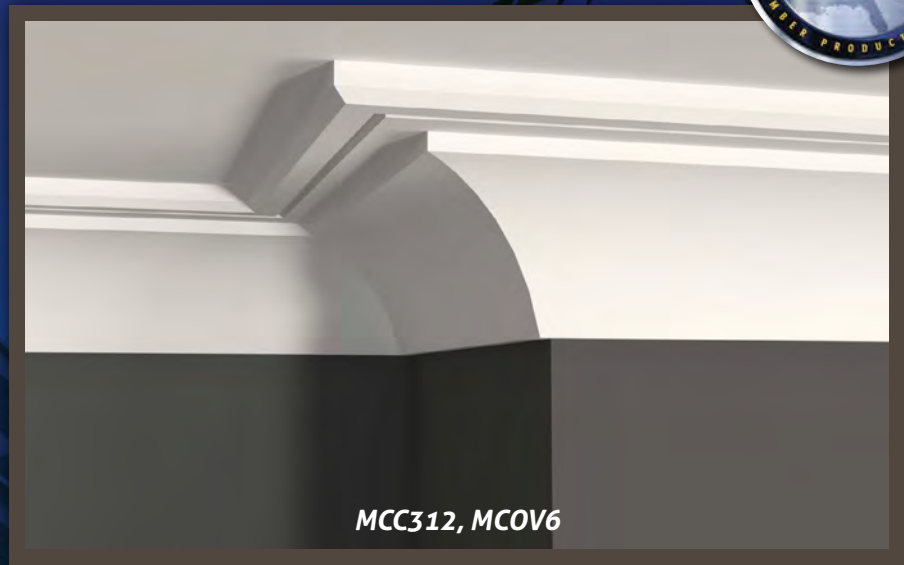

STEP COVES



MCR514, MCC312

Ceiling

MCR514

Wall

MCC312



MCR714

1-1/16" x 7-1/4"

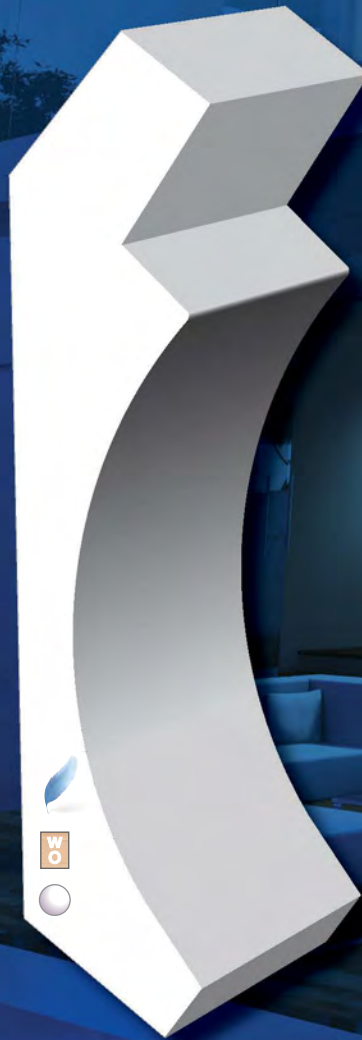

MCR514

1-1/16" x 5-1/4"



MCR514 Ceiling Step



MCR514 Wall Step

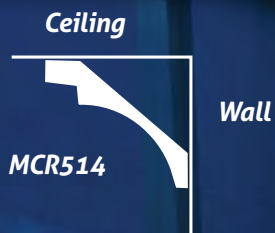

Projection: 3-7/8" Height: 3-1/2"

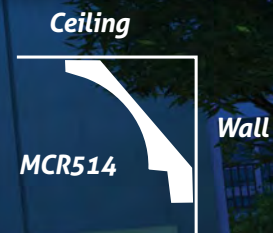

Projection: 3-1/2" Height: 3-7/8"



MCR714 Ceiling Step

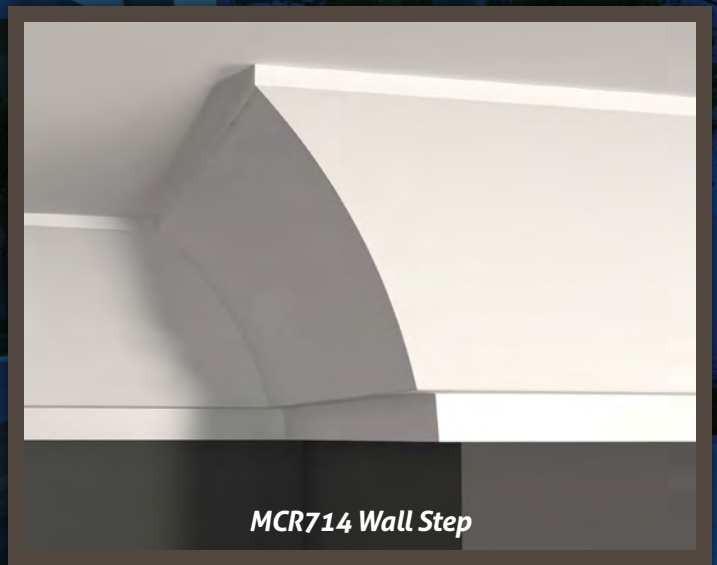

MCR714 Wall Step



Projection: 5-1/2" Height: 4-5/8"



Projection: 4-5/8" Height: 5-1/2"

CROWNS



MCR750
1-1/8" x 7-1/2"
Projection: 5-1/4"
Height: 5-1/4"



MCR650
1-1/8" x 6-1/2"
Projection: 4-5/8"
Height: 4-5/8"



MCR550
1-1/8" x 5-1/2"
Projection: 3-7/8"
Height: 3-7/8"

CROWNS



MCR550 Ceiling Step



MCR550 Wall Step



MCR650 Ceiling Step



MCR650 Wall Step

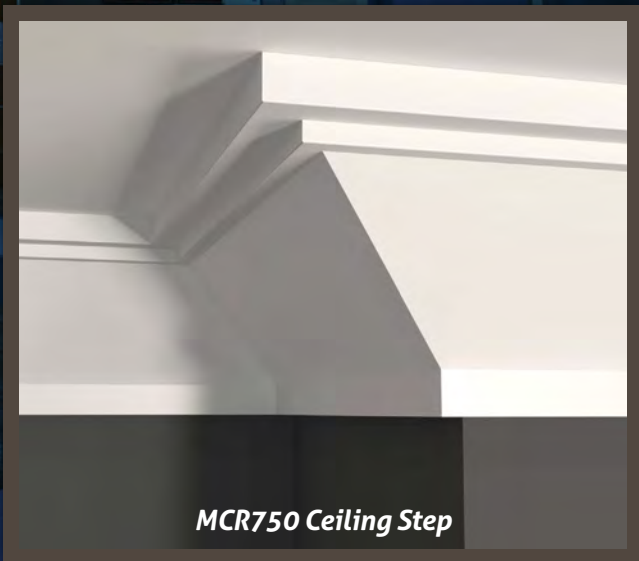

MCR750 Ceiling Step



MCR750 Wall Step

Add our Metro Caps & Panels to our crowns
for an endless array of design details



MSC175
7/8" x 1-3/4"



MCAP34
5/8" x 1-3/4"



MCAP1
3/4" x 1-1/16"



MCAP2
3/4" x 1-1/16"



MCS1
5/8" x 1"

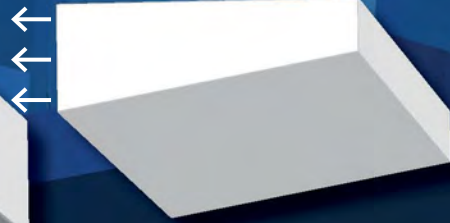

MCR550 Step on Wall, MCAP1 Bottom, MCAP34 on Top

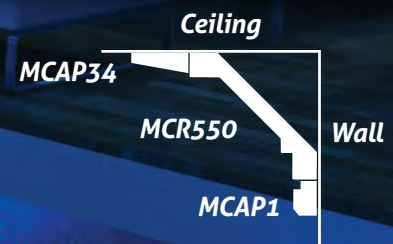

CROWN BUILD UPS



MCR550 Step on Wall, MCAP1

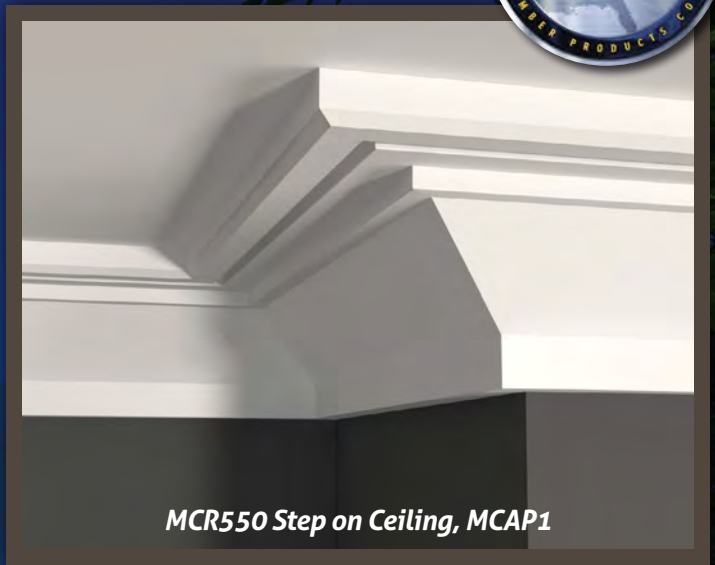

MCR550 Step on Ceiling, MCAP1

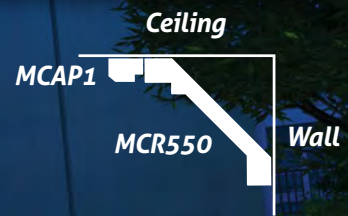
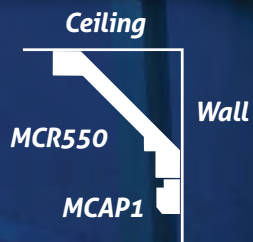

MCR550 Step on Wall, MCAP1, MCC412



MCR550 Step on Ceiling, MCAP1, MCC412

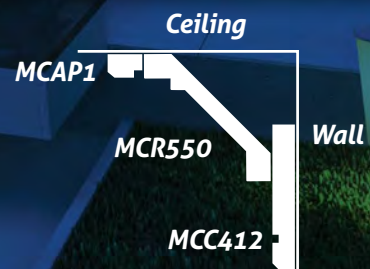

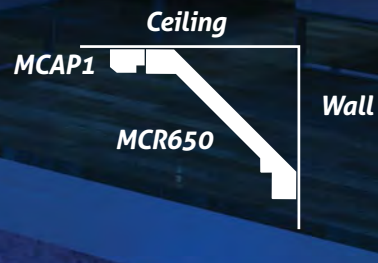
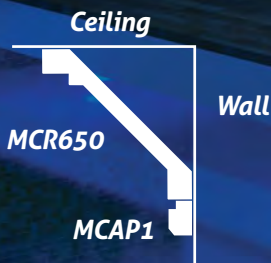
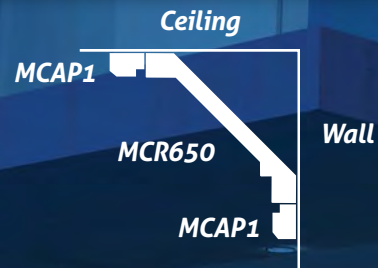
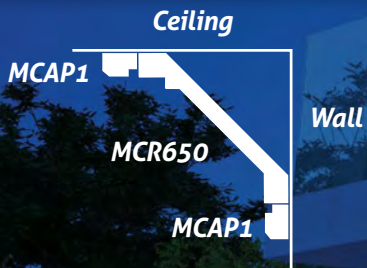

CROWN BUILD UPS



MCR650 Step on Wall, MCAP2

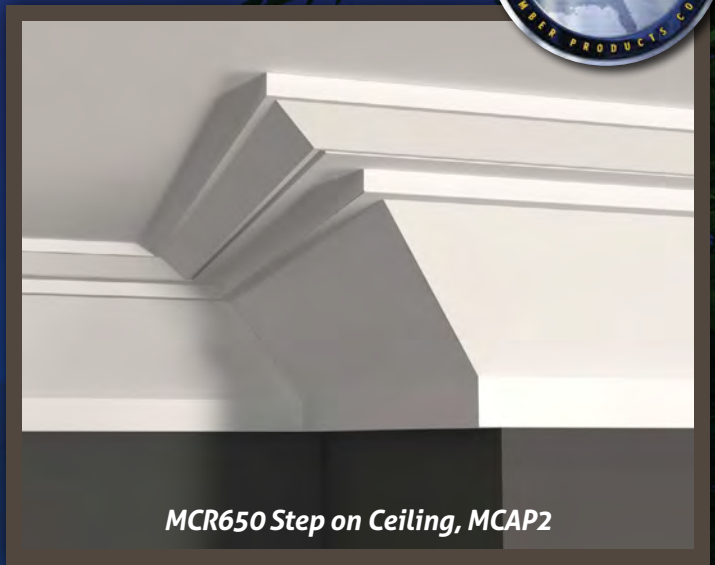

MCR650 Step on Ceiling, MCAP2

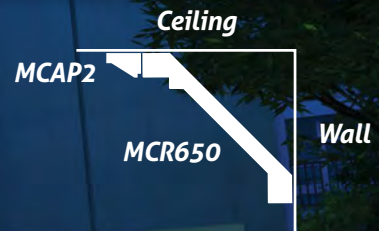
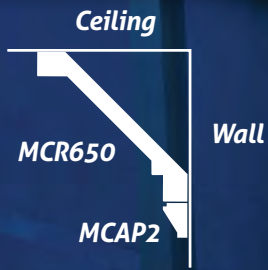

MCR650 Step on Ceiling, MSC175, MCS1



MCR650 Step on Wall, MSC175, MCS1





MCR650 Step on Ceiling, MCAP34



MCR650 Step on Wall, MSC175, MCAP1

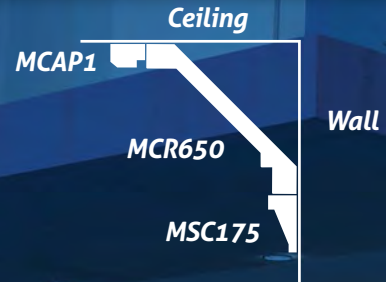

MCR750 Step on Wall, MCAP34



MCR750 Step on Wall, MSC175



CROWN BUILD UPS



MCR750 Step on Ceiling, MCAP1, MCS1



MCR750 Step on Wall, MCAP1, MCS1

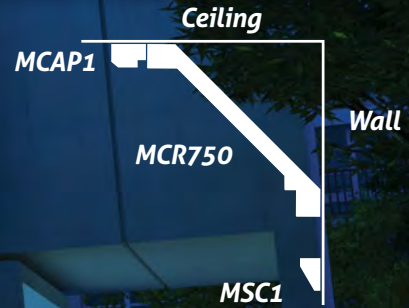
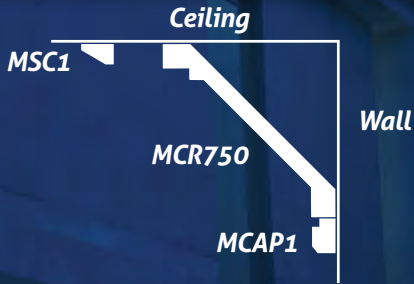

MCR750 Step on Ceiling, MCAP34



MCR750 Step on Wall, MCAP34

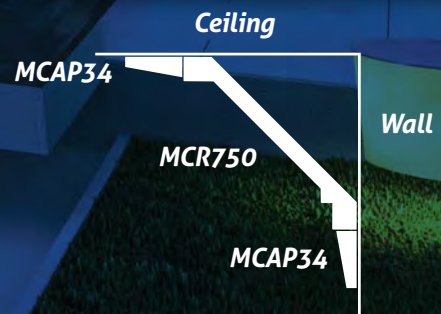
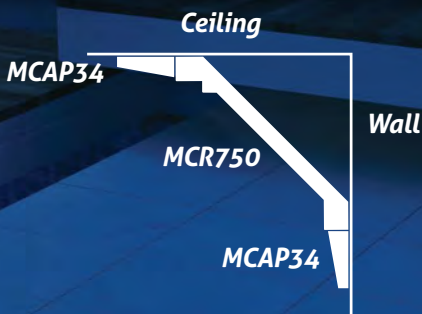

THE METRO COLLECTION



- 1 **SCOOP7**
- 2 **STEP55**
- 3 **MCR750**
- 4 **NG714 T&G**

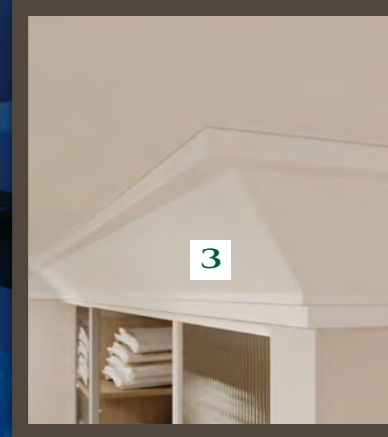
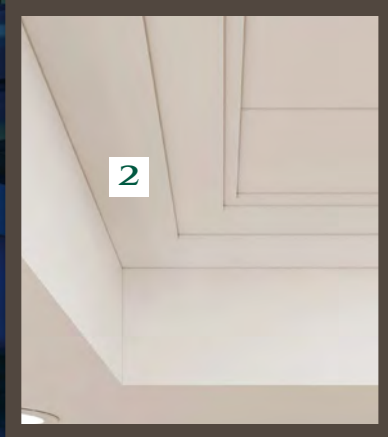



- 1 **MCB712**
- 2 **MCR550**
- 3 **MCC312**
- 4 **NG714 T&G**

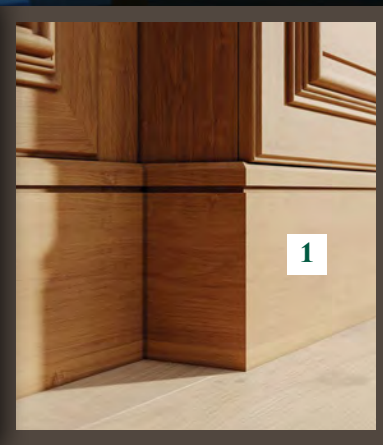

1

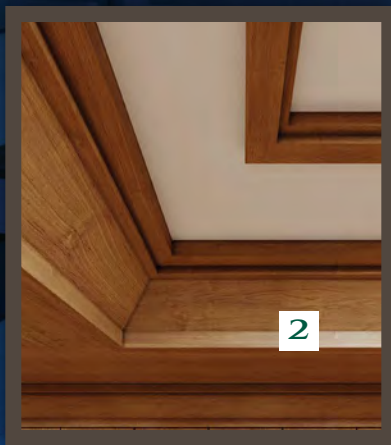

2

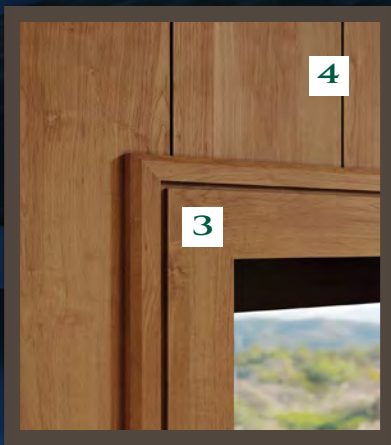

3

4

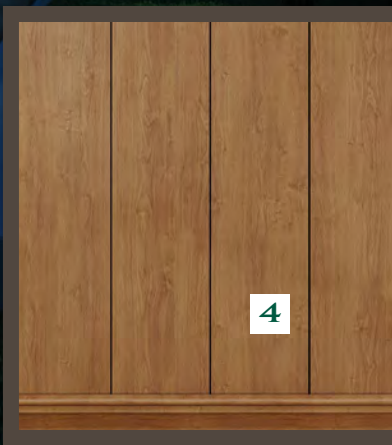

4

The
DESIGNER
COLLECTION
PRIMED POPLAR MOULDINGS

THERE IS A CROSSROADS WHERE SOPHISTICATION OF MOULDING DESIGN intersects with the highest quality material and millwork craftsmanship. It is in this space that *The DESIGNER COLLECTION* was born...

The DESIGNER COLLECTION is a compilation of 24 distinct profiles that are as substantial in size as they are in the design possibilities they offer.

Comprised of the highest grade FJ Poplar substrate and coated with our proprietary 4 step priming system, *The DESIGNER COLLECTION* is meticulously manufactured to be the highest quality Moulding product available in the market today.

With a robust inventory of **18' mouldings** and 16' S4S boards, as well as our custom run and arched millwork capabilities, we can accommodate the most intricate fabrications your imagination can create...

-
- **18' LONG PRIMED POPLAR MOULDINGS**
 - › *minimizes waste on casings*
 - › *minimizes seams on bases and crowns*
 - **IMMACULATE MILLING AND 4-STEP PRIMING SYSTEM (DOUBLE PRIMED AND DOUBLE BUFFED)**
 - **CUSTOM RUN OUR DESIGNER COLLECTION PATTERNS IN ANY HARDWOOD SPECIES**
 - **CUSTOM RUN YOUR OWN MOULDING PROFILES IN PRIMED POPLAR OR ANY HARDWOOD SPECIES**
 - **SPECIAL ORDER FOR ANY ARCHED CASING OR CURVED CROWN APPLICATION**
-



CASINGS

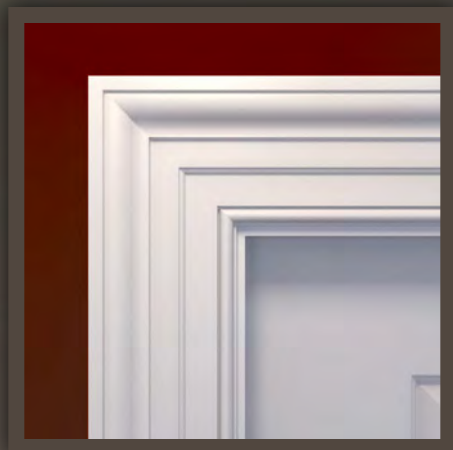

DC400

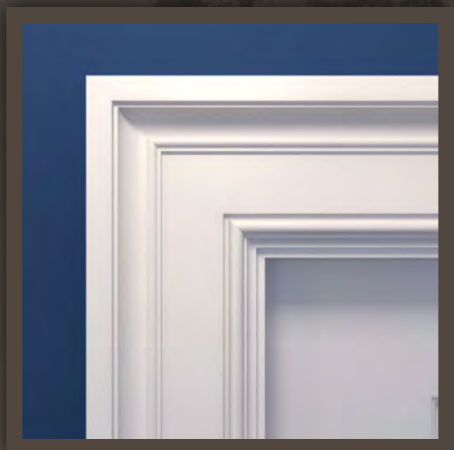

DC412



DC450



DC400
1-5/16" x 4"
18' Lengths



DC412
1-7/16" x 4-1/2"
18' Lengths



DC450
1-5/8" x 4-1/2"
18' Lengths

The
DESIGNER
COLLECTION
PRIMED POPLAR MOULDINGS

CASINGS



DCWC5

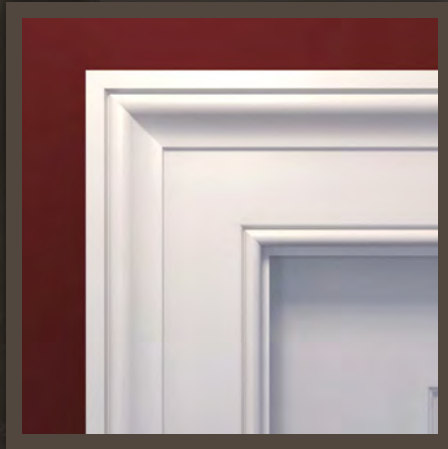

DCLK5



DC499



DCWC5
1-1/2" x 4-7/8"
18' Lengths



DCLK5
1-1/2" x 5"
18' Lengths

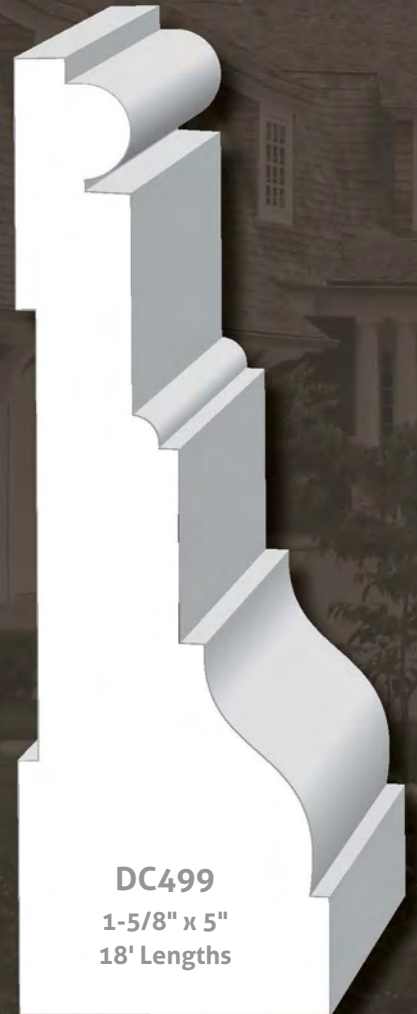

DC499
1-5/8" x 5"
18' Lengths



DCAS5



DC512



DC550



DCAS5

1-3/4" x 5-1/2"
18' Lengths

* Also used as Chair Rail

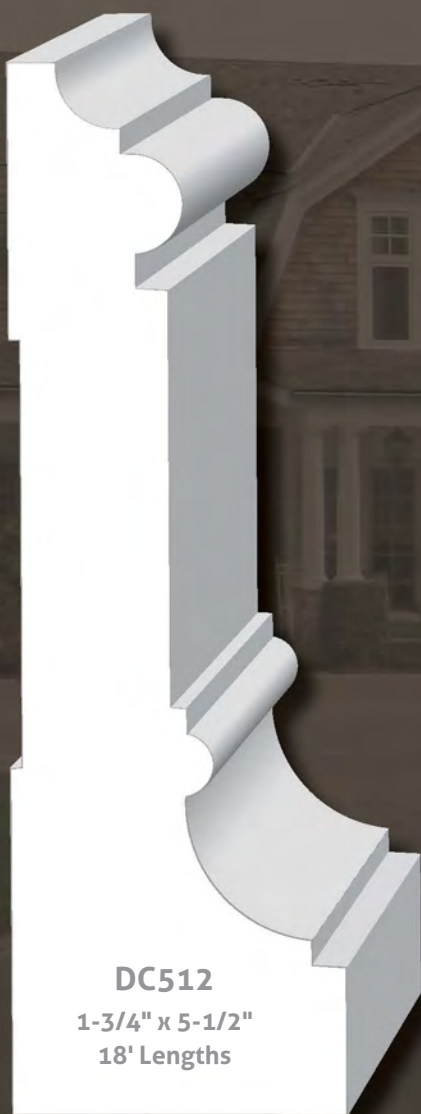

DC512

1-3/4" x 5-1/2"
18' Lengths



DC550

2" x 5-1/2"
18' Lengths

The
DESIGNER
COLLECTION
PRIMED POPLAR MOULDINGS

BASES



DCB525
13/16" x 5-1/4"
18' Lengths



DCBB5
3/4" x 5-1/2"
18' Lengths



DCB534
13/16" x 5-3/4"
18' Lengths

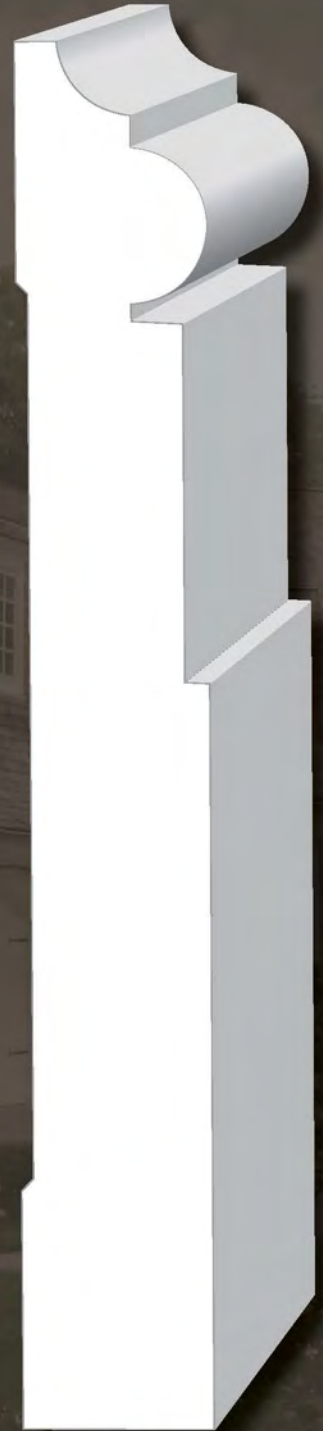

DCB714
1" x 7-1/4"
18' Lengths



DCB525



DCBB5



DCB534



DCB714

The
DESIGNER
COLLECTION
PRIMED POPLAR MOULDINGS



DCB775
1-1/16" x 7-3/4"
18' Lengths

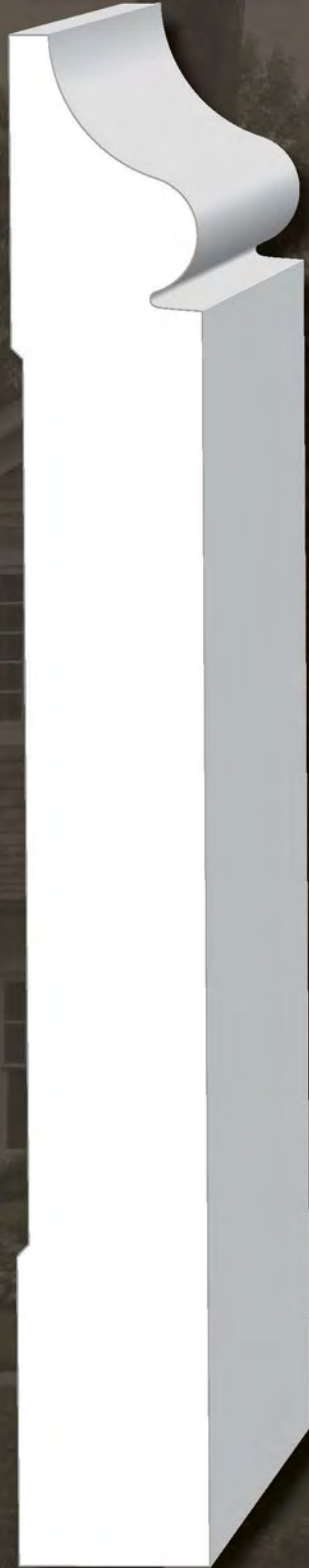

DCB8
1" x 8"
18' Lengths



DCB825
1-5/16" x 8-1/4"
18' Lengths



DCB925
7/8" x 9-1/4"
18' Lengths

BASES



DCB775



DCB8

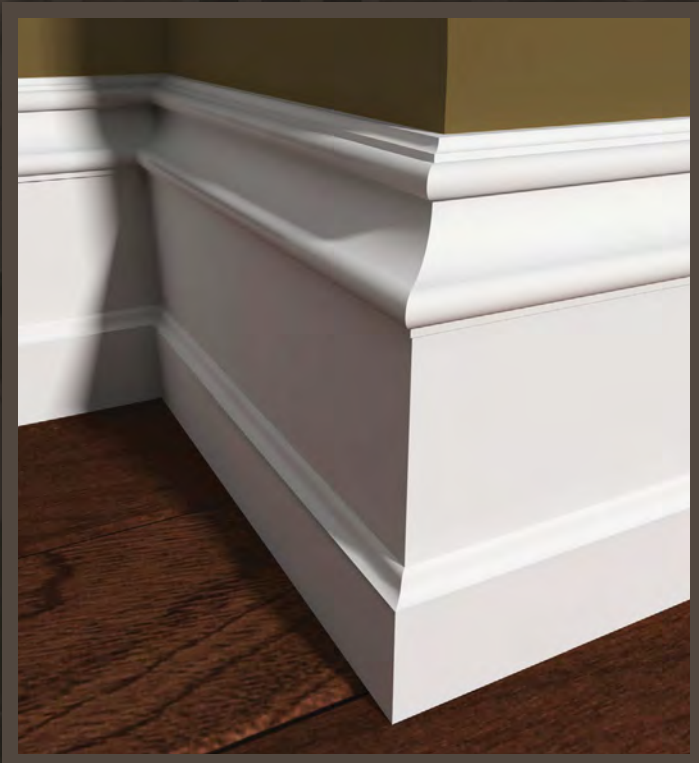

DCB825



DCB925

CHAIR RAIL,
 BASES & CASINGS



DCAS5
 1-3/4" x 5-1/2"
 18' Lengths

DCAS5 used as a Chair Rail



DC400 Casing and DCB525 Base

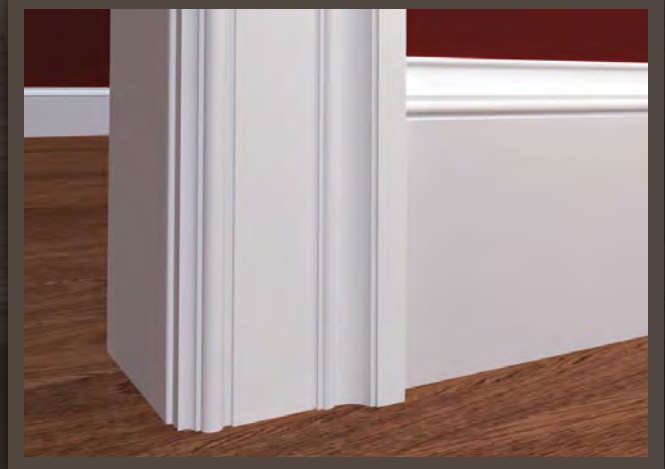

DC412 Casing and DCB775 Base



DC412 Casing and DCBB5 Base

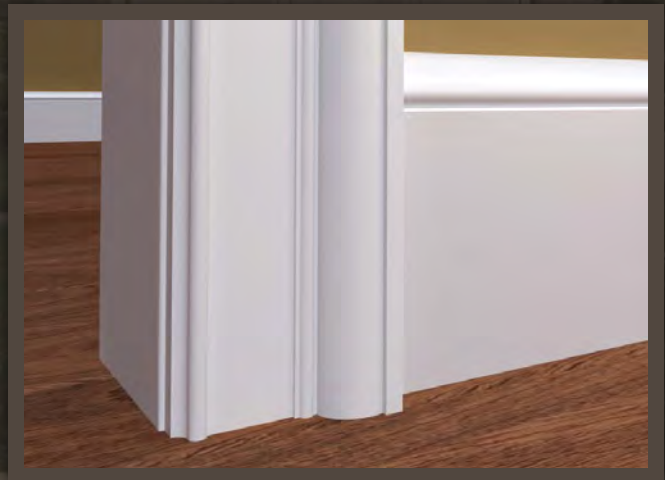

DC450 Casing and DCB8 Base



BASES & CASINGS

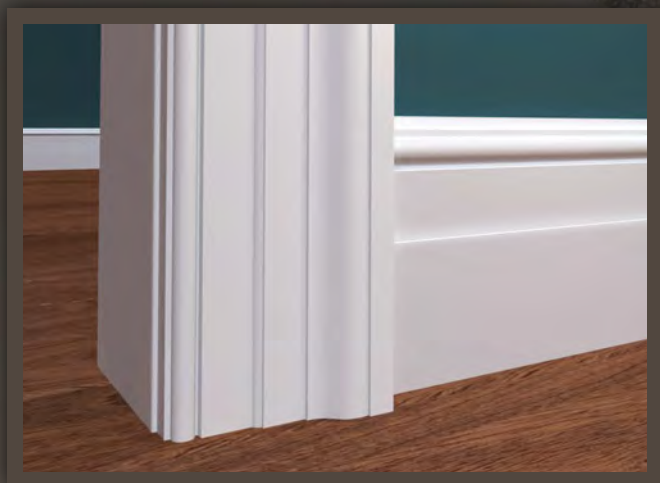

DC499 Casing and DCB714 Base

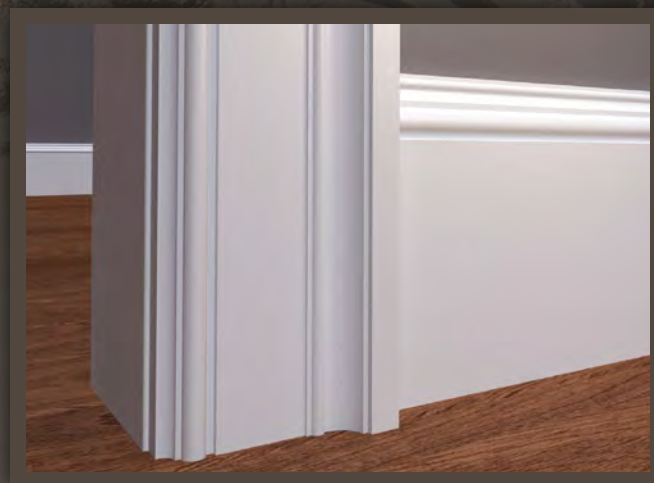

DC512 Casing and DCB925 Base



DC550 Casing and DCB825 Base

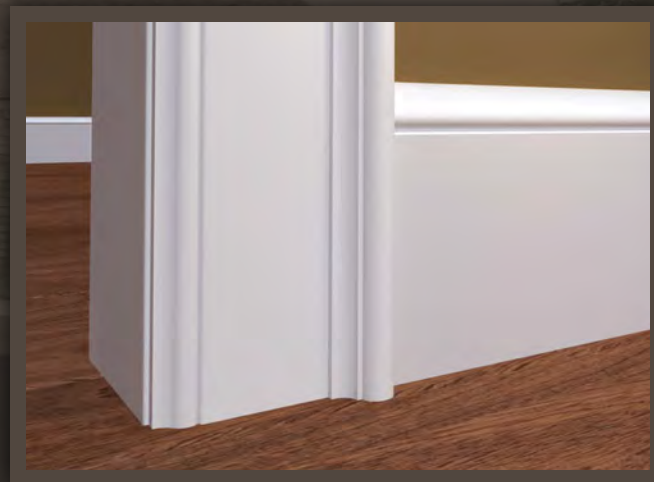

DCAS5 Casing and DCB8 Base

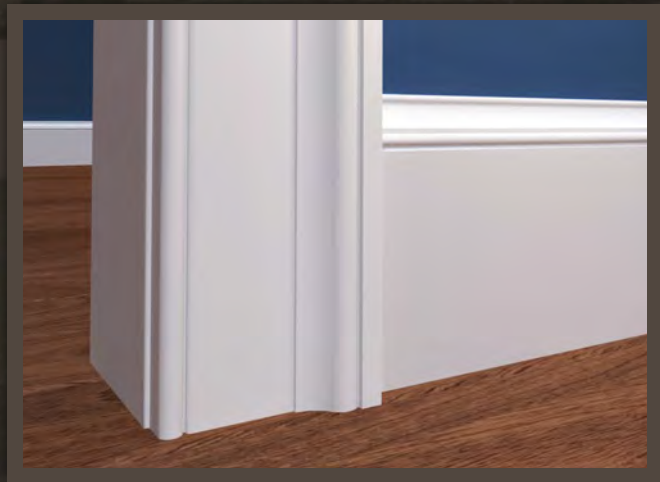

DCLK5 Casing and DCB775 Base



DCWC5 Casing and DCB534 Base

The
DESIGNER

COLLECTION

PRIMED POPLAR MOULDINGS

COVES/CROWNS

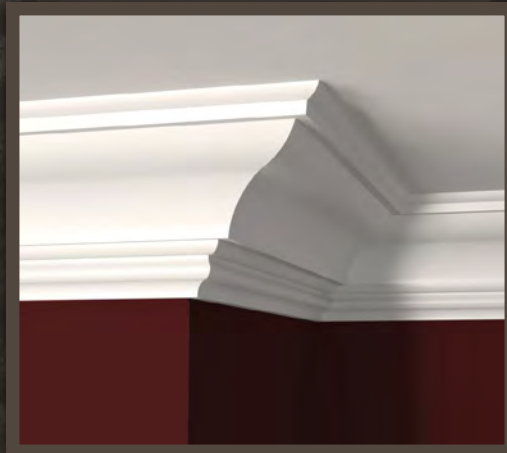

DCR512

13/16" x 5-1/2"

18' Lengths

Projection: 4" Height: 3-7/8"



DCR558

1-5/16" x 5-5/8"

18' Lengths

Projection: 4" Height: 4"



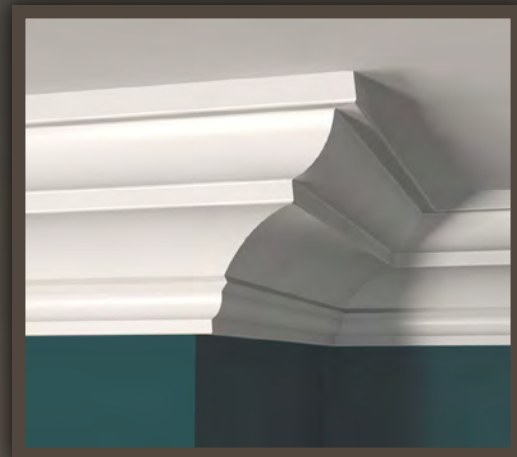

DCR612

1" x 6-1/2"

18' Lengths

Projection: 4-1/2" Height: 4-3/4"



DCR634

1-3/4" x 6-3/4"

18' Lengths

Projection: 4-1/2" Height: 5-1/8"

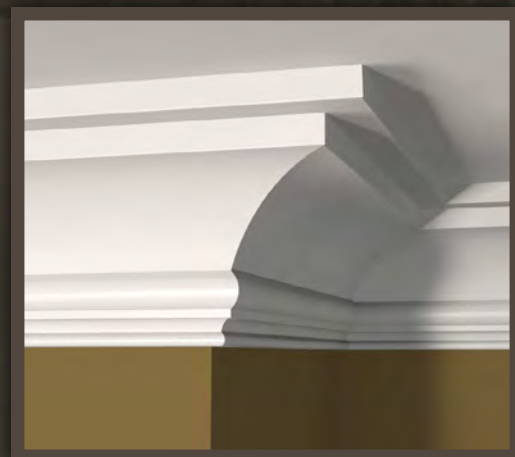

The
DESIGNER

COLLECTION

PRIMED POPLAR MOULDINGS

COVES/CROWNS

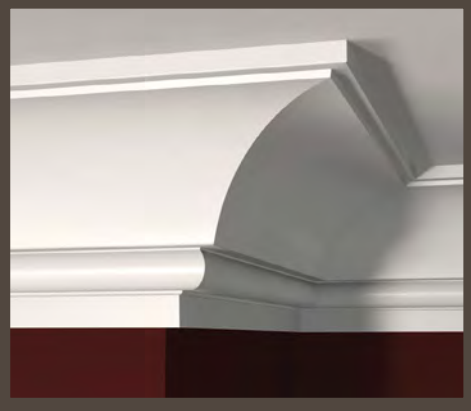

DCR725

1-5/16" x 7-1/4"

18' Lengths

Projection: 5-1/4"

Height: 5-1/8"

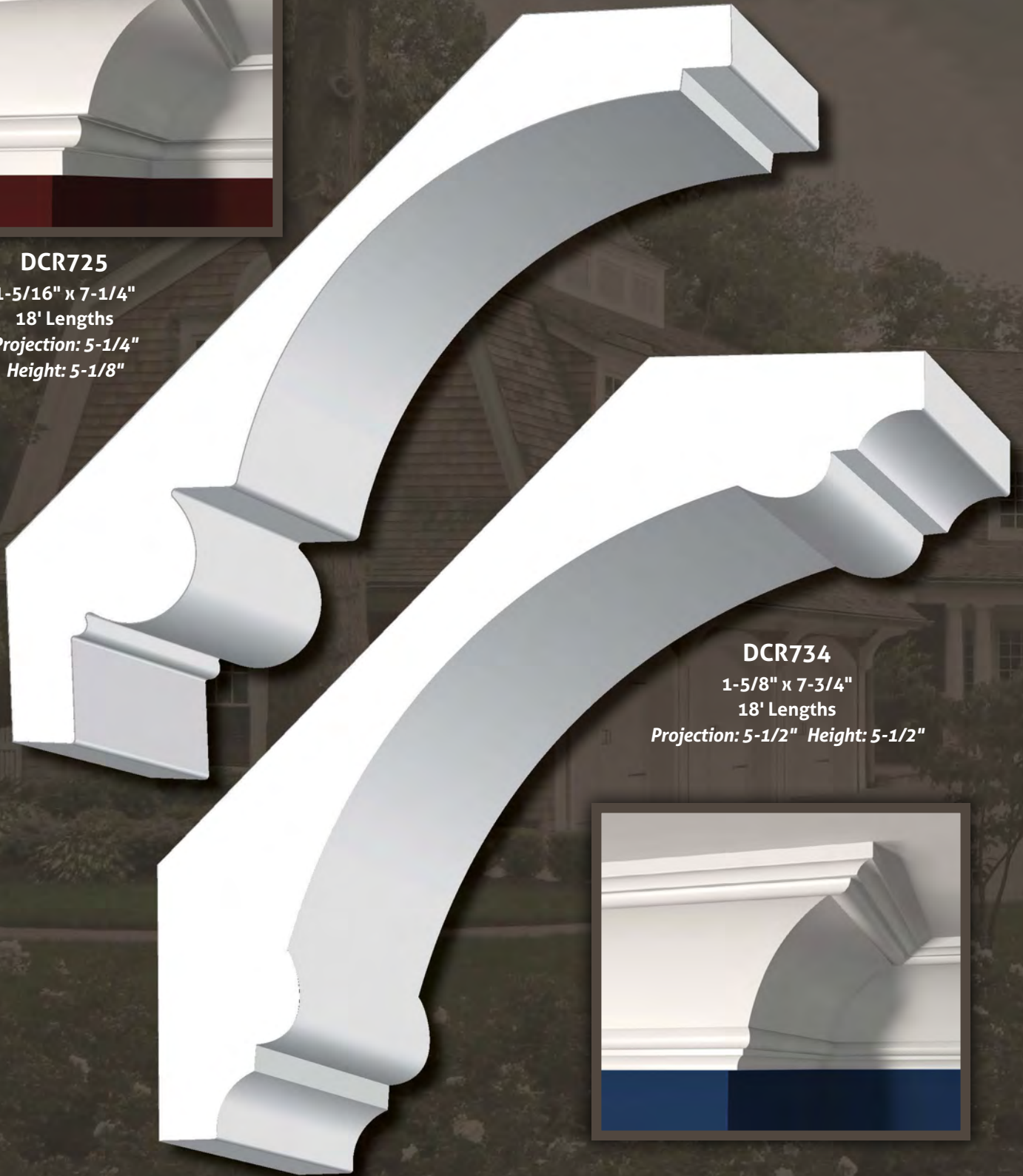

DCR734

1-5/8" x 7-3/4"

18' Lengths

Projection: 5-1/2" Height: 5-1/2"





COVES/CROWNS

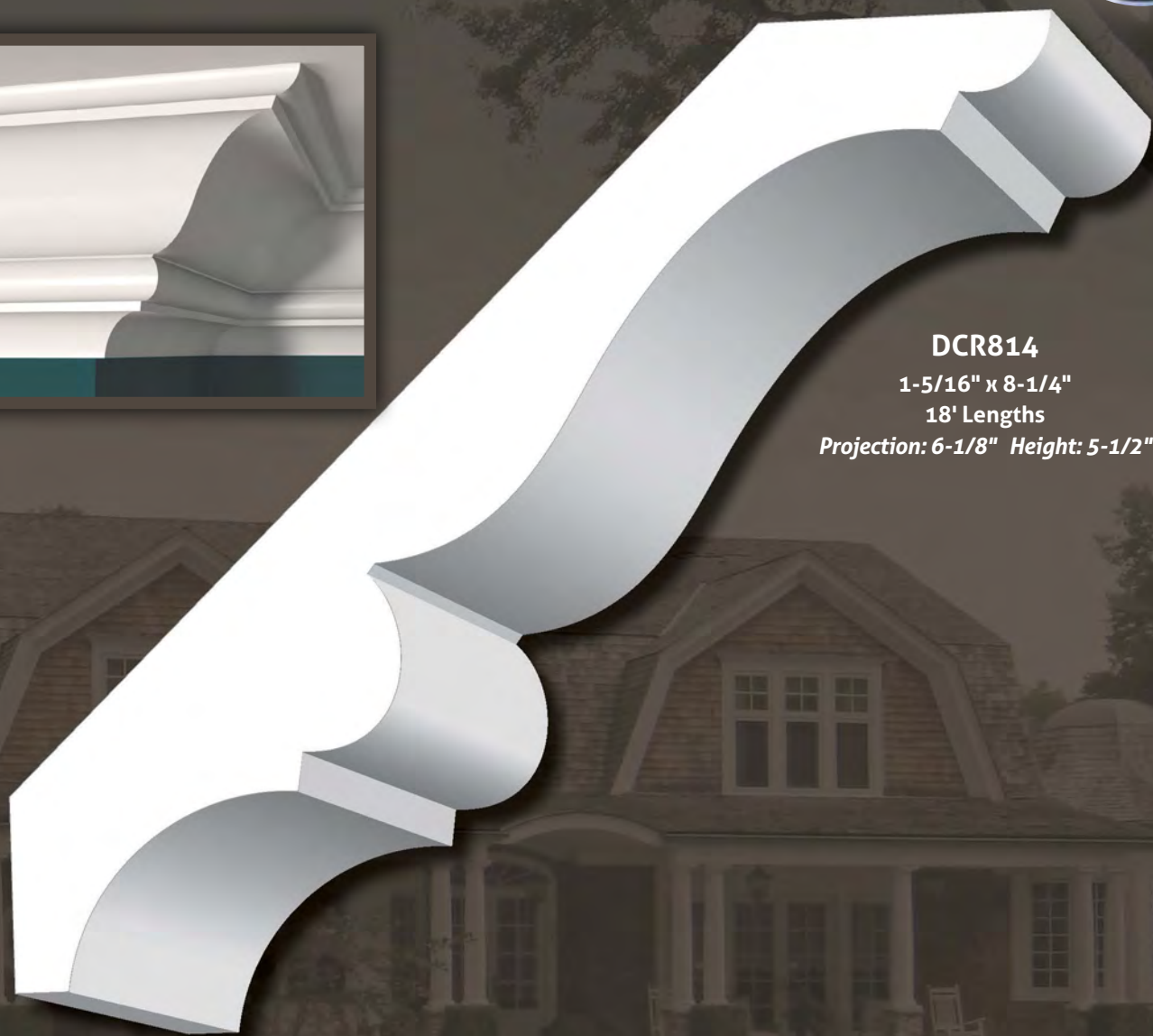

DCR814
 1-5/16" x 8-1/4"
 18' Lengths
 Projection: 6-1/8" Height: 5-1/2"



PRIMED POPLAR
 Primed 4 sides - 16' lengths

PRIMED POPLAR S4S

NOMINAL SIZE	ACTUAL SIZE	SKU	NOMINAL SIZE	ACTUAL SIZE	SKU
1 x 3	3/4 x 2-1/2	D13POP-PRF			
1 x 4	3/4 x 3-1/2	D14POP-PRF	5/4 x 4	1-1/16 x 3-1/2	D544POP-PRF
1 x 6	3/4 x 5-1/2	D16POP-PRF	5/4 x 6	1-1/16 x 5-1/2	D546POP-PRF
1 x 8	3/4 x 7-1/4	D18POP-PRF	5/4 x 8	1-1/16 x 7-1/4	D548POP-PRF
1 x 10	3/4 x 9-1/4	D110POP-PRF	5/4 x 10	1-1/16 x 9-1/4	D5410POP-PRF
1 x 12	3/4 x 11-1/4	D112POP-PRF	5/4 x 12	1-1/16 x 11-1/4	D5412POP-PRF
1 x 16	3/4 x 15-1/4	D116POP-PRF			



GARDEN STATE LUMBER is proud to introduce **GS MILLWORK**. GS Millwork is the nation's premier manufacturer of premium hardwood S4S trimboards and architectural millwork.

"Quality is not an act, it is a habit"

GARDEN STATE LUMBER STOCK S4S BOARD PROGRAM

NOMINAL SIZE	ACTUAL SIZE	POPLAR	RED OAK	WHITE OAK	HARD MAPLE	CHERRY	SAPELE	WALNUT
1 x 2	3/4 x 1-1/2	D12POP	D12OAK	D12WO	D12MA		D12SAP	D12WAL
1 x 3	3/4 x 2-1/2	D13POP	D13OAK	D13WO	D13MA		D13SAP	D13WAL
1 x 4	3/4 x 3-1/2	D14POP	D14OAK	D14WO	D14MA	D14CH	D14SAP	D14WAL
1 x 5	3/4 x 4-1/2	D15POP						
1 x 6	3/4 x 5-1/2	D16POP	D16OAK	D16WO	D16MA	D16CH	D16SAP	D16WAL
1 x 8	3/4 x 7-1/4	D18POP	D18OAK	D18WO	D18MA	D18CH	D18SAP	D18WAL
1 x 10	3/4 x 9-1/4	D110POP	D110OAK	D110WO	D110MA	D110CH	D110SAP	D110WAL
1 x 12	3/4 x 11-1/4	D112POP	D112OAK	D112WO	D112MA	D112CH	D112SAP	D112WAL
5/4 x 4	1 x 3-1/2	D544POP	D544OAK	D544WO	D544MA		D544SAP	
5/4 x 6	1 x 5-1/2	D546POP	D546OAK	D546WO	D546MA		D546SAP	
5/4 x 8	1 x 7-1/4	D548POP	D548OAK	D548WO	D548MA		D548SAP	
5/4 x 10	1 x 9-1/4	D5410POP	D5410OAK				D5410SAP	
5/4 x 12	1 x 11-1/4	D5412POP	D5412OAK				D5412SAP	
8/4 x 4	1-1/2 x 3-1/2	D844POP	D844OAK				D844SAP	
8/4 x 6	1-1/2 x 5-1/2	D846POP	D846OAK				D846SAP	
8/4 x 8	1-1/2 x 7-1/4	D848POP	D848OAK				D848SAP	
8/4 x 12	1-1/2 x 11-1/4	D8412POP	D8412OAK				D8412SAP	

All GS Millwork S4S is precision end trimmed and stamped with length indication. All sizes and species not listed in the chart above can be special ordered (3 weeks or less).



Poplar S4S

White to tan in color, straight grained, crisp & versatile, ideal for painting

1x2 (3/4 x 1-1/2)	1x3 (3/4 x 2-1/2)	1x4 (3/4 x 3-1/2)	1x5 (3/4 x 4-1/2)	1x6 (3/4 x 5-1/2)	1x8 (3/4 x 7-1/4)	1x10 (3/4 x 9-1/4)	1x12 (3/4 x 11-1/4)
5/4 x 4 (1 x 3-1/2)	5/4 x 6 (1 x 5-1/2)	5/4 x 8 (1 x 7-1/4)	5/4 x 10 (1 x 9-1/4)	5/4 x 12 (1 x 11-1/4)			
8/4 x 4 (1-1/2 x 3-1/2)	8/4 x 6 (1-1/2 x 5-1/2)	8/4 x 8 (1-1/2 x 7-1/4)	8/4 x 12 (1-1/2 x 11-1/4)				

Available Lengths: 8' - 16'



Red Oak S4S

Reddish brown in color, tight grained, durable, ideal for finish and stain

1x2 (3/4 x 1-1/2)	1x3 (3/4 x 2-1/2)	1x4 (3/4 x 3-1/2)	1x6 (3/4 x 5-1/2)	1x8 (3/4 x 7-1/4)	1x10 (3/4 x 9-1/4)	1x12 (3/4 x 11-1/4)
5/4 x 4 (1 x 3-1/2)	5/4 x 6 (1 x 5-1/2)	5/4 x 8 (1 x 7-1/4)	5/4 x 10 (1 x 9-1/4)	5/4 x 12 (1 x 11-1/4)		
8/4 x 4 (1-1/2 x 3-1/2)	8/4 x 6 (1-1/2 x 5-1/2)	8/4 x 8 (1-1/2 x 7-1/4)	8/4 x 12 (1-1/2 x 11-1/4)			

Available Lengths: 8' - 16'



White Oak S4S

Light brown in color, strong, beautiful, rot resistant, finishes and stains exceptionally well

1x2 (3/4 x 1-1/2)	1x3 (3/4 x 2-1/2)	1x4 (3/4 x 3-1/2)	1x6 (3/4 x 5-1/2)	1x8 (3/4 x 7-1/4)	1x10 (3/4 x 9-1/4)	1x12 (3/4 x 11-1/4)
5/4 x 4 (1 x 3-1/2)	5/4 x 6 (1 x 5-1/2)	5/4 x 8 (1 x 7-1/4)				

Available Lengths: 6' - 16' (Heavy 6' - 12', Minimal 13' - 16')



Hard Maple S4S

White to pinkish-tan in color, extremely strong and versatile, great for both staining and painting

1x2 (3/4 x 1-1/2)	1x3 (3/4 x 2-1/2)	1x4 (3/4 x 3-1/2)	1x6 (3/4 x 5-1/2)	1x8 (3/4 x 7-1/4)	1x10 (3/4 x 9-1/4)	1x12 (3/4 x 11-1/4)
5/4 x 4 (1 x 3-1/2)	5/4 x 6 (1 x 5-1/2)	5/4 x 8 (1 x 7-1/4)				

Available Lengths: 8' - 16' (Heavy 8' - 12', Minimal 13' - 16')



Cherry S4S

Pinkish-brown in color, straight grained, beautiful machining and finishing qualities

1x4 (3/4 x 3-1/2)	1x6 (3/4 x 5-1/2)	1x8 (3/4 x 7-1/4)	1x10 (3/4 x 9-1/4)	1x12 (3/4 x 11-1/4)
-----------------------------	-----------------------------	-----------------------------	------------------------------	-------------------------------

Available Lengths: 8' - 16' (Heavy 8' - 12', Occasional 13' - 16')



Sapele S4S

Dark reddish-brown in color, unique grain structure, unmistakable in its beauty, outstanding wood for both interior and exterior applications

1x2 (3/4 x 1-1/2)	1x3 (3/4 x 2-1/2)	1x4 (3/4 x 3-1/2)	1x6 (3/4 x 5-1/2)	1x8 (3/4 x 7-1/4)	1x10 (3/4 x 9-1/4)	1x12 (3/4 x 11-1/4)
5/4x4 (1 x 3-1/2)	5/4x6 (1 x 5-1/2)	5/4x8 (1 x 7-1/4)	5/4x10 (1 x 9-1/4)	5/4x12 (1 x 11-1/4)		
8/4x4 (1-1/2 x 3-1/2)	8/4x6 (1-1/2 x 5-1/2)	8/4x8 (1-1/2 x 7-1/4)	8/4x12 (1-1/2 x 11-1/4)			

Available Lengths: 8' - 16'

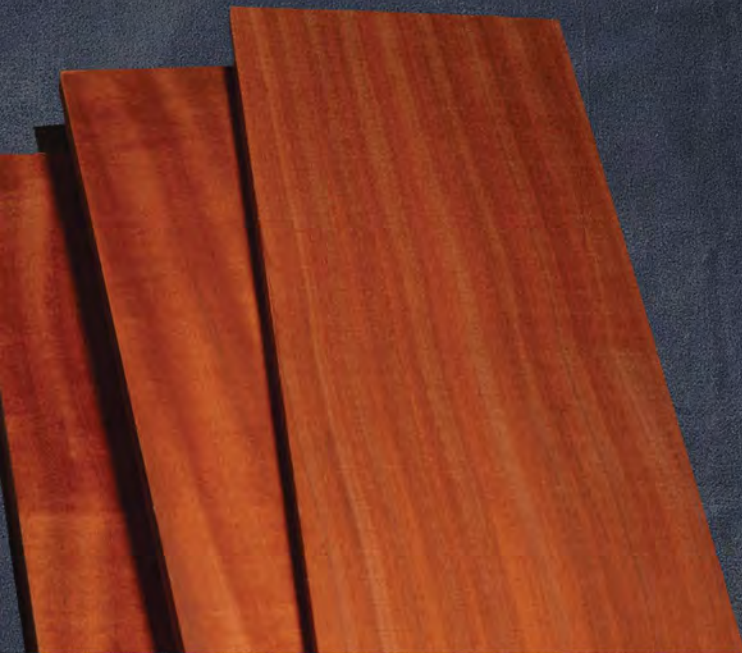

Walnut S4S

Light to dark chocolate brown in color, dense and tight grained, one of the most sought-after wood species, bold and rich when stained or clear coated

1x2 (3/4 x 1-1/2)	1x3 (3/4 x 2-1/2)	1x4 (3/4 x 3-1/2)	1x6 (3/4 x 5-1/2)	1x8 (3/4 x 7-1/4)	1x10 (3/4 x 9-1/4)	1x12 (3/4 x 11-1/4)
-----------------------------	-----------------------------	-----------------------------	-----------------------------	-----------------------------	------------------------------	-------------------------------



Available Lengths: 6' - 16' (Heavy 6' - 12', Occasional 13' - 16')



Tongue & Groove – Nickel Gap

(IN STOCK – 1 WEEK OR LESS)

Solid Poplar **primed available on a Quick Ship basis*

NOMINAL SIZE	ACTUAL SIZE	POPLAR	1/8" NICKEL GAP
1 x 6	3/4 x 5-1/2	NG512POP	
1 x 8	3/4 x 7-1/4	NG714POP	
1 x 10	3/4 x 9-1/4	NG914POP	



Custom S4S Capabilities

- Most domestic and import hardwood species
- Solid S4S up to 2" thick and 11-1/2" wide
- Edge glued panels up to 30" wide
- Finish options: Unfinished, Primed, Clear Coated
- Short lead times of 3 weeks or sooner
- No minimum quantity requirements



Custom Run Mouldings and Millwork

- Most domestic and import hardwood species
- ALL Garden State Lumber patterns available
- Custom patterns up to 11-1/2" wide
- Finish options: Unfinished, Primed, Clear Coated
- In house CAD Design and Toolings
- Short lead times of 3 weeks or sooner
- No minimum quantity requirements

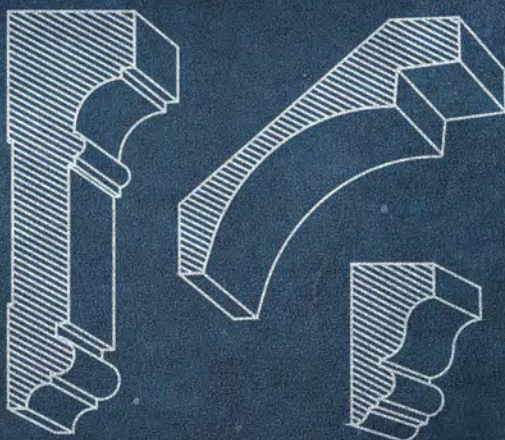

SCALE 1/2" = 1 FT.
DRAWN BY:
TRACED BY:
CHECKED BY:

REVISION 1 2 3
BY

Quick Ship Tongue & Groove and Shiplap

(3 WEEKS OR SOONER)

If you're looking for something unique, GS Millwork offers a wide variety of sizes, patterns, species and finishes of tongue & groove & shiplap products with a short lead time. Follow our simple four-step process to select the perfect product for your project.

1 Choose Your Product Size

1x4
(3/4 x 3-1/2)

1x6
(3/4 x 5-1/2)

1x8
(3/4 x 7-1/4)

1x10
(3/4 x 9-1/4)

1x12
(3/4 x 11-1/4)

2 Choose Your Style/Pattern



EDGE & CENTER BEAD (ECB)



fit detail



EDGE BEAD (EB)



fit detail



V-GROOVE (VG)



fit detail



T&G NICKEL GAP (NG)



fit detail

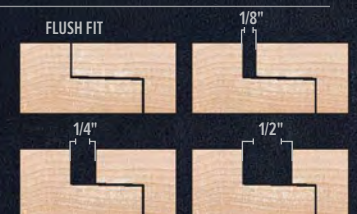

see the following page for
fit detail options

SHIPLAP GAP OPTIONS *select Flush Fit, 1/8", 1/4", or 1/2" Gap*



FLUSH



1/8" GROOVE



1/4" GROOVE



1/2" GROOVE

3 Choose Your Wood Species



FJ POPLAR*

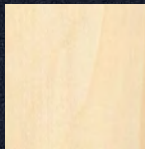

POPLAR



PINE (RADIATA)

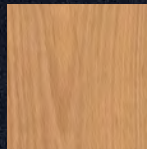

RED OAK

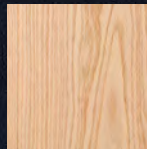

WHITE OAK

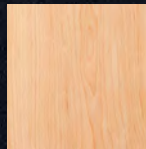

MAPLE



CHERRY

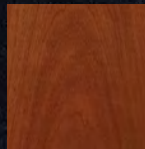

SAPELE



WALNUT

*Length structure varies by species and width selection : 6' and longer on all species
(*16' lengths on FJ Poplar)*

1x10 and 1x12 subject to availability on the following species: White Oak, Maple, Walnut, and Cherry

Additional hardwood species are available in a four week lead time. Please call for price & availability

4 Choose Your Finish

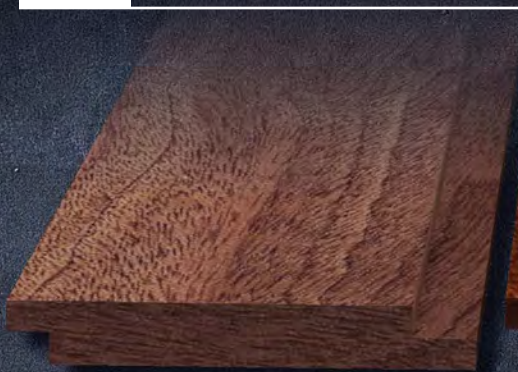

UNFINISHED



CLEAR COAT

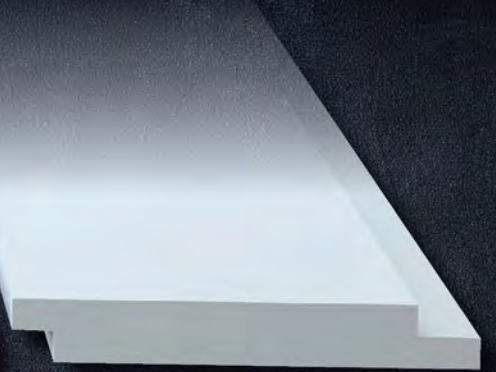

PRIMED

AVAILABLE WOOD SPECIES *for* CUSTOM MOULDINGS & S4S

FJ Poplar

Thickness: 4/4" & 5/4" (up to 1-1/16")

Lengths: 8' & 16'

Widths: up to 11-1/2"

**Additional Sizes and length are available on a special order basis (6 week lead time)*

Poplar

Thickness: 4/4" thru 10/4" (up to 2")

Lengths: 8' - 16'

Widths: up to 11-1/2"

**Longer length tallies can be requested at an Up charge*

Pine (Radiata)

Thickness: 4/4" thru 6/4" (up to 1-7/16")

Lengths: 8' - 16'

Widths: up to 11-1/2"

Red Oak

Thickness: 4/4" thru 8/4" (up to 1-3/4")

Lengths: 8' - 16'

Widths: up to 11-1/2"

White Oak

Thickness: 4/4" & 5/4" (up to 1-1/16")

Lengths: 6' - 12' (occasional 13'-16')

Widths: up to 11-1/2"

**10" and wider are subject to availability*

AVAILABLE WOOD SPECIES *for* CUSTOM MOULDINGS & S4S



Maple (Hard)

Thickness: 4/4" thru 6/4" (up to 1-7/16")
Lengths: 8' - 16' (Heavy 8'-12')
Widths: up to 11-1/2"

Cherry

Thickness: 4/4" & 5/4" (up to 1-1/16")
Lengths: 8' & 12' (occasional 13'-16')
Widths: up to 11-1/2"

**Additional Sizes and length are available on a special order basis (5 week lead time)*

Sapele

Thickness: 4/4" thru 8/4" (up to 1-3/4")
Lengths: 8' - 16'
Widths: up to 11-1/2"

Walnut

Thickness: 4/4" & 5/4" (up to 1-1/16")
Lengths: 6' - 12' (occasional 13'-16')
Widths: up to 11-1/2"

**10" and wider are subject to availability*

Special Order

Additional Species and width / length specifications are available upon request. Longer lead times may apply

HARDWOODS

COLLECTION

QUICK SHIP 3 WEEKS OR SOONER

Crowns



UC31H

3/4 x 3-3/4



UC41H

3/4 x 4-5/8



COV412H

1-1/16 x 4-1/2



CRW2H

11/16 x 2

L8010H

3/4 x 2-1/2

L8009H

11/16 x 3-1/2

8013H

11/16 x 4-1/2

8027H

11/16 x 5-1/4



POPLAR



WHITE OAK



RED OAK



MAPLE



CHERRY



SAPELE

QUICK SHIP PROGRAM:

- The profiles depicted on the following pages are available in 3 weeks or sooner.
- Poplar • Red Oak • Maple • Cherry • Sapele (Mahogany)
- No minimum quantities required

CUSTOM RUN PROGRAM:

- **All Garden State Lumber Moulding Profiles** can be custom run in most hardwood and softwood species
- 4 week lead time or sooner
- No minimum quantities required



Solid Crowns



Profiles are available in 3 weeks or sooner. Custom runs are available in 4 weeks or sooner.

HARDWOODS

COLLECTION

QUICK SHIP 3 WEEKS OR SOONER



BB5H

3/4 x 5

BB7H

3/4 x 7

Bases

BB458H

11/16 x 4-5/8



8712H

11/16 x 3-1/2



Base Caps



BC78H

11/16 x 7/8



WM164H

11/16 x 1-1/8

LWM163H

11/16 x 1-5/8



8412H

11/16 x 1-3/8



8416H

11/16 x 1-5/8

Shoe/Floor Mouldings



SH1H

1/2 x 1



SH78H

1/2 x 7/8



8423H

1/2 x 3/4



8422H

1/2 x 3/4



POPLAR



WHITE OAK

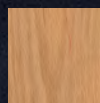

RED OAK



MAPLE



CHERRY



SAPELE

Casings



GS419H

1-1/16 x 4-1/2



WC1H

1-1/16 x 3-5/8



B8746H

11/16 x 3-5/8



GS119H

7/8 x 3-1/2



L8753H

11/16 x 3-1/2



LWM445H

13/16 x 3-3/8



8753H

11/16 x 2-1/2



WM376H

13/16 x 2-3/8

Profiles are available in 3 weeks or sooner. Custom runs are available in 4 weeks or sooner.

HARDWOODS

COLLECTION

QUICK SHIP 3 WEEKS OR SOONER

Chair Rails

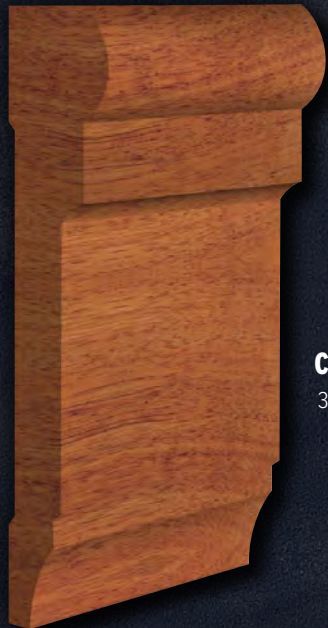

CR314H
3/4 x 3-1/4

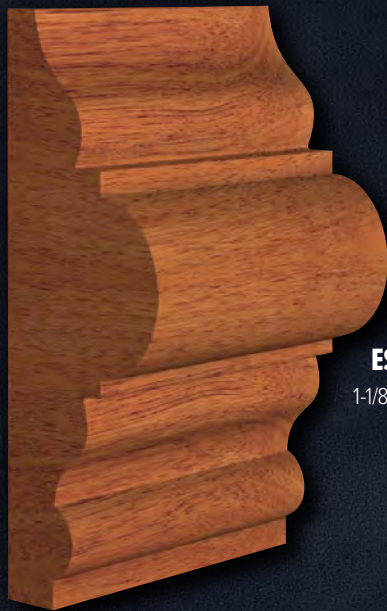

ES7H
1-1/8 x 3-1/8



LWM297H
3/4 x 2-3/4

Nose & Coves



8575H
3/8 x 1/2

8577H
5/8 x 3/4

8578H
11/16 x 1-1/8

Quarter Rounds



8063H
1/2 x 1/2

8065H
3/4 x 3/4

Coves



WP101H
1/2 x 1/2

WM93H
3/4 x 3/4

8024H
9/16 x 1-5/8

CV278H
13/16 x 2-7/8

Half Rounds



HR12H
1/4 x 1/2

HR34H
3/8 x 3/4

HR1H
1/2 x 1

HR15H
3/4 x 1-1/2

HR2H
1 x 2

HR3H
1-1/2 x 3

Flat Stools



FS312H
1 x 3-1/2

F1021H
1 x 5-1/2





Panel Mouldings



LWM135H
3/8 x 7/8



WM130H
7/16 x 1-1/8



LWM133H
3/4 x 1-1/2



PL2H
1 1/16 x 2



RPL34H
3/4 x 1-13/16



RPL214H
13/16 x 2-1/4



PLP312H
1-3/16 x 3-1/2

Stop Mouldings



G8090H
3/8 x 2-1/2

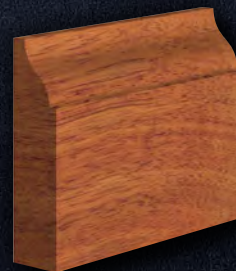

D8090H
3/8" x 1-3/8

CUSTOM ARCHES

& Architectural Accents

ARCH CASINGS

- Available in Primed MDF, PVC, most hardwood species
- $\frac{3}{16}$ " Reveal will be added to all supplied measurements & templates
- Reveal can be adjusted upon specification
- Most casings for Andersen units can be manufactured by Andersen unit number

ELLIPTICALS

SHOWN: ES1 EASTERN WHITE PINE



Measurement Required: A Measurement Only – Inside Width Jamb to Jamb

Elliptical units require a template of the jamb supplied on Red Rosin paper, Tyvek, or any flat surface durable paper (cardboard templates tend to lose the measurement accuracy required once folded). A measurement must be supplied with template to ensure accuracy of finished product.

EYEBROWS / ARCHES

SHOWN: GS419 IN AMERICAN CHERRY

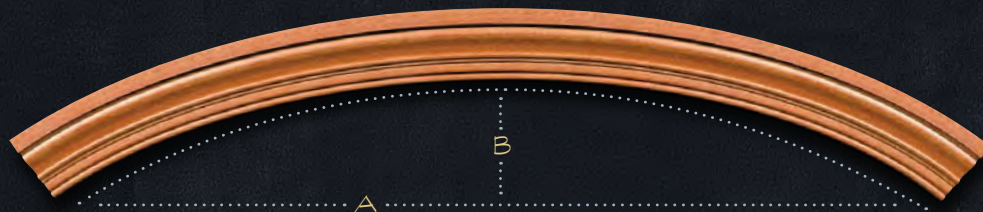

Measurements Required:

- A Measurement - Unit Width/Inside Jamb to Jamb
- B Measurement - Chord Height to Inside of Jamb

WWW.GARDENSTATELUMBER.COM

NORTHEAST REGION:
PHONE: (800)526-4708

SOUTHEAST REGION:
PHONE: (800)296-0288



HALF ROUNDS

SHOWN: PL458 PRIMED MDF

Measurements Required:

- A Measurement Only - Inside Jamb To Jamb

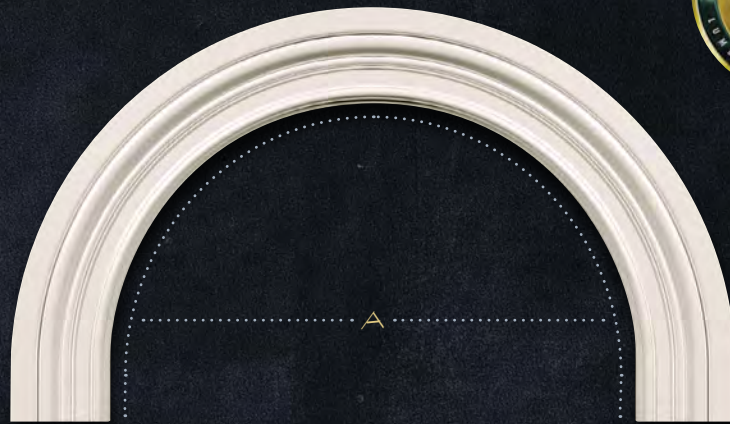

OVALS

SHOWN: ES1 IN PVC

Measurements Required:

- A Measurement - Unit Width Inside Jamb to Jamb
- B Measurement - Unit Height Inside Jamb to Jamb

TEMPLATE REQUIRED

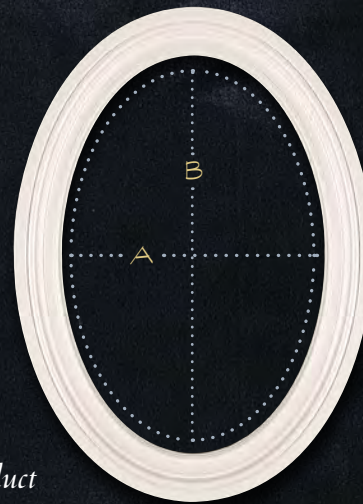

** All our milled PVC Arches will have a factory applied bonding primer to obtain a smooth finished product*

Oval units require a template of the jamb supplied on Red Rosin paper, Tyvek, or any flat surface durable paper (cardboard templates tend to lose the measurement accuracy required once folded). A and B measurements must be supplied with template to ensure accuracy of finished product.

FULL ROUNDS

SHOWN: 5/4 X 4 (1" X 3-1/2") PVC

Measurements Required:

- A Measurement Only - Unit Width/Inside Jamb to Jamb (diameter)

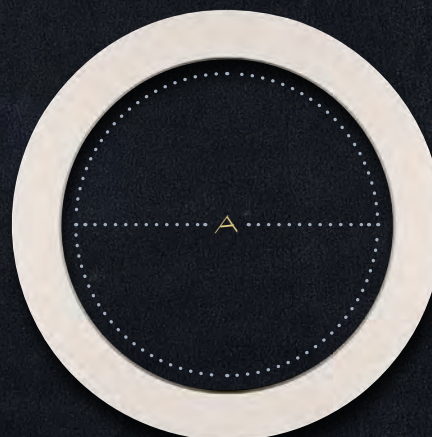

WWW.GARDENSTATELUMBER.COM

NORTHEAST REGION:
PHONE: (800)526-4708

SOUTHEAST REGION:
PHONE: (800)296-0288

BEADED PANEL

& STRIP PRODUCTS

nantucket®
beadboard

Introducing our newest line of beaded panels and strip products. We have now expanded our line of primed MDF beadboard to include all of Nantucket Beadboard's product offerings and manufacturing capabilities.

- Broadened mix of on ground inventory
- Quick ship program for all non stock products
- Custom profile & pattern availability
- No minimum quantities

Stock items = 1-3 day lead time

Quick Ship items = 3 week lead time

Special Order items = 4 week lead time

GARDEN STATE LUMBER STOCK

IN STOCK FOR IMMEDIATE SHIPMENT



Standard Bead – 2" & 3" On Center

4' x 8' Sheet Shown at 15%



THICKNESS	MDF			MRI/NAF*	PVC
	4' x 8'	4' x 10'	4' x 12'	4' x 8'	4' x 8'
1/4"	14-SB2SB 14-SB3SB				
1/2"	SB2SB SB3SB	SB2SB-10 SB3SB-10	SB2SB-12 SB3SB-12	SB2SB-MRI SB3SB-MRI	SB2SB-PVC SB3SB-PVC

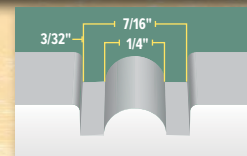

V-Bead – 1 5/8" & 2 1/2" On Center

4' x 8' Sheet Shown at 15%



THICKNESS	MDF			MRI/NAF*	PVC
	4' x 8'	4' x 10'	4' x 12'	4' x 8'	4' x 8'
1/4"	14-SB158VB 14-SB212VB				
1/2"	SB158VB SB212VB	SB158VB-10 SB212VB-10	SB158VB-12 SB212VB-12	SB158VB-MRI SB212VB-MRI	SB158VB-PVC SB212VB-PVC

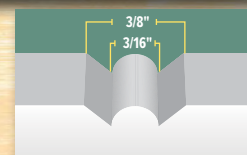

Modern Groove (1/4" x 1/4") – 6" On Center

4' x 8' Sheet Shown at 15%



THICKNESS	MDF			MRI/NAF*	PVC
	4' x 8'	4' x 10'	4' x 12'	4' x 8'	4' x 8'
1/2"	SB6MG	SB6MG-10	SB6MG-12		

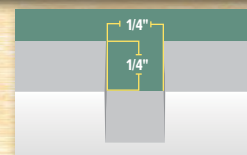

Nickel Gap (1/8" x 1/4") – 6" & 8" On Center

4' x 8' Sheet Shown at 15%

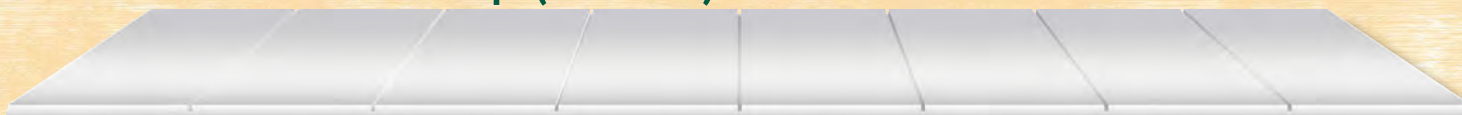

THICKNESS	MDF			MRI/NAF*	PVC
	4' x 8'	4' x 10'	4' x 12'	4' x 8'	4' x 8'
1/2"	SB6NK SB8NK	SB6NK-10 SB8NK-10	SB6NK-12 SB8NK-12		

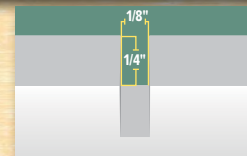

V-Groove – 6" On Center

4' x 8' Sheet Shown at 15%



THICKNESS	MDF			MRI/NAF*	PVC
	4' x 8'	4' x 10'	4' x 12'	4' x 8'	4' x 8'
1/2"	SB6VG	SB6VG-10	SB6VG-12	SB6VG-MRI	SB6VG-PVC

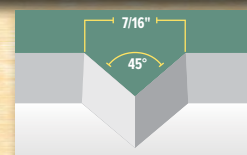

*Primed On Both Sides



- 1 MCOV8, MCC312, 1x8 S4S
- 2 MCC312, MCBB2
- 3 WC214
- 4 2-1/2 ON CENTER V-BEAD (1/4" THICK)
- 5 MCB7

WWW.GARDENSTATELUMBER.COM

QUICK SHIP+ SHEET PRODUCTS

3 WEEK LEAD TIME NO MINIMUM QUANTITIES



Standard Bead Quick Ship Items

AVAILABLE 2" AND 3" ON CENTER

4' x 8' Sheet Shown at 15%



THICKNESS	MDF	MRI/NAF	MRX	FR MDF	PVC
3/8"	4' x 8' 4' x 10' 4' x 12'				
1/2"	4' x 16'	4' x 10' 4' x 16'	4' x 8'	4' x 8'	4' x 8'

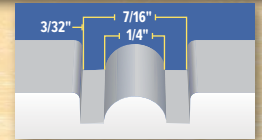

V-Bead Quick Ship Items

AVAILABLE 1 5/8" AND 2 1/2" ON CENTER

4' x 8' Sheet Shown at 15%



THICKNESS	MDF	MRI/NAF	MRX	FR MDF	PVC
3/8"	4' x 8' 4' x 10' 4' x 12'				
1/2"	4' x 16'	4' x 10' 4' x 16'	4' x 8'	4' x 8'	4' x 8'

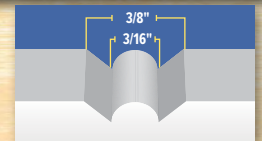

V-Groove Quick Ship Items

AVAILABLE 4", 6" AND 8" ON CENTER

4' x 8' Sheet Shown at 15%



THICKNESS	MDF	MRI/NAF	MRX	FR MDF	PVC
1/2"	4' x 8' 4' x 10' 4' x 12' 4' x 16'	4' x 8' 4' x 10' 4' x 16'	4' x 8'	4' x 8'	4' x 8'

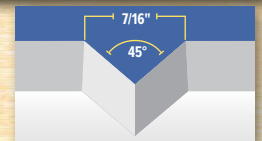

MRI = MOISTURE RESISTANT / NO ADDED FORMALDEHYDE ■ MRX = EXTERIOR MDF ■ FR= FIRE RATED (CLASS A)



- 1 8" ON CENTER V-GROOVE
- 2 LK4
- 3 FS312 STOOL, LK3 APRON

QUICK SHIP+ SHEET PRODUCTS

3 WEEK LEAD TIME

Modern Grooves & Nickel Gap

AVAILABLE 4", 6" AND 8" ON CENTER

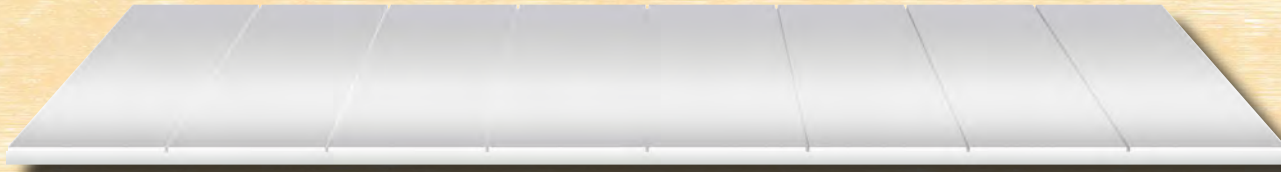

1/8" x 1/8" Nickel Gap

4' x 8' Sheet Shown at 15%

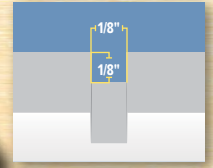

1/8" x 1/4" Nickel Gap

4' x 8' Sheet Shown at 15%

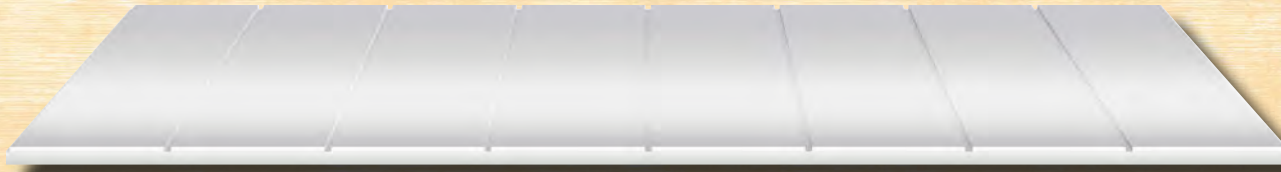
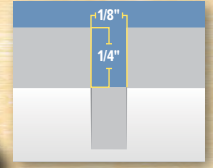

1/4" x 1/8" Modern Groove

4' x 8' Sheet Shown at 15%

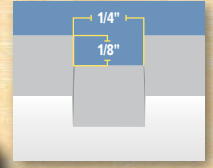

1/4" x 1/4" Modern Groove

4' x 8' Sheet Shown at 15%

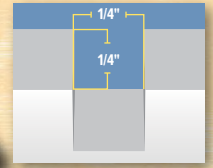

THICKNESS	MDF	MRI/NAF	MRX	FR MDF	PVC
1/4"	8'*				
3/8"	4' x 8' 4' x 10' 4' x 12'*				
1/2"	4' x 8' 4' x 10' 4' x 12' 4' x 16'	4' x 8' 4' x 10' 4' x 16'	4' x 8'	4' x 8'	4' x 8'

*Only Available In 1/4" x 1/8" & 1/8" x 1/8"

MRI = MOISTURE RESISTANT / NO ADDED FORMALDEHYDE ■ MRX = EXTERIOR MDF ■ FR = FIRE RATED (CLASS A)



1

1 1/4" x 1/4" MODERN GROOVE (4" ON CENTER)

2 GSB725

3 LK4

2

3

1 1/8" x 1/4" MODERN GROOVE (4" ON CENTER)

2 1x4, SC214, FS312

1

2

WWW.GARDENSTATELUMBER.COM



1

2

3

4

5

- 1 1/4" x 1/4" MODERN GROOVE (4" ON CENTER)
- 2 1x6, 1x3, MSC275
- 3 MCR750
- 4 MCB512
- 5 1/4" x 1/4" MODERN GROOVE (8" ON CENTER)



- 1 **1/4" x 1/4" MODERN GROOVE (8" ON CENTER)**
- 2 **COV312**
- 3 **ES12**
- 4 **1/4" x 1/4" MODERN GROOVE (4" ON CENTER)**
- 5 **1/4" x 1/4" MODERN GROOVE (4" ON CENTER)**
- 6 **BB7**



- 1 **SBC514, CB312**
- 2 **SC234, 8578, 1X8**
- 3 **ES12**
- 4 **1/4" x 1/4" MODERN GROOVE (6" ON CENTER)**
- 5 **FS312, CGM31**
- 6 **BB738, SH1**

QUICK SHIP+ SHEET PRODUCTS

3 WEEK LEAD TIME



Random VG-1 & Random VG-2



Random VG-1

4' x 8' Sheet Shown at 15%



Random VG-2

4' x 8' Sheet Shown at 15%

THICKNESS	MDF	MRI/NAF	MRX	FR MDF	PVC
1/2"	4' x 8' 4' x 10' 4' x 12' 4' x 16'	4' x 8' 4' x 10' 4' x 16'	4' x 8'	4' x 8'	4' x 8'

Most patterns depicted in this catalogue can be special ordered to the Random 1 and Random 2 configurations.

Random 1: 3½", 5½", 5½", 7½", 5½", 3½", 7½", 4½", 5 = 48"

Random 2: 4", 6", 8", 4", 6", 8", 4", 8" = 48"

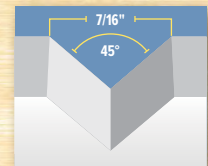

Mini V-Groove & Mini Mini V-Groove

AVAILABLE 4", 6" AND 8" ON CENTER



Mini V-Groove

4' x 8' Sheet Shown at 15%

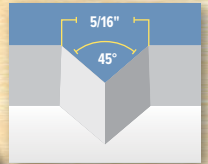

Mini Mini V-Groove

4' x 8' Sheet Shown at 15%

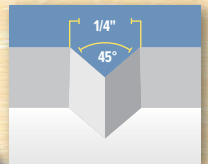

THICKNESS	MDF	MRI/NAF	MRX	FR MDF	PVC
1/4"	8' (Mini Mini V-Groove Only)				
3/8"	4' x 8' 4' x 10' 4' x 12'				
1/2"	4' x 8' 4' x 10' 4' x 12' 4' x 16'	4' x 8' 4' x 10' 4' x 16'	4' x 8'	4' x 8'	4' x 8'

SHIPLAP STRIP PRODUCTS

3 WEEK LEAD TIME

Outstanding for Ceiling Applications

Another elegant solution we offer from Nantucket BeadBoard is their shiplap strip products. These easy to install strips dramatically increase your building options by giving you another dimension in beadboard.

- **Ideal For Ceiling Applications**
- **Easy To Handle**
- **Dramatically Decreases Your Install Time**
- **Short Lead Time Of 3 Weeks**

Standard Bead

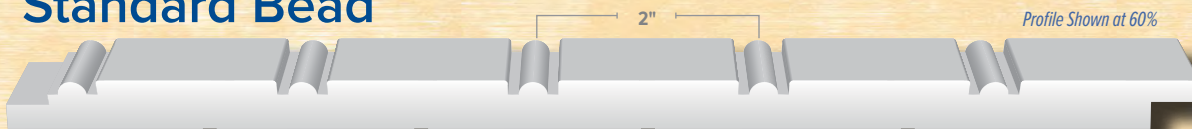

2" STANDARD BEAD (10" FACE) 1 LINEAL FT = .83 SQ FT – ORDER IN 4 PIECE INCREMENTS

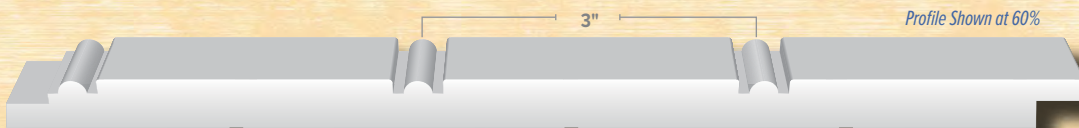

3" STANDARD BEAD (9" FACE) 1 LINEAL FT = .75 SQ FT – ORDER IN 5 PIECE INCREMENTS

V-Bead

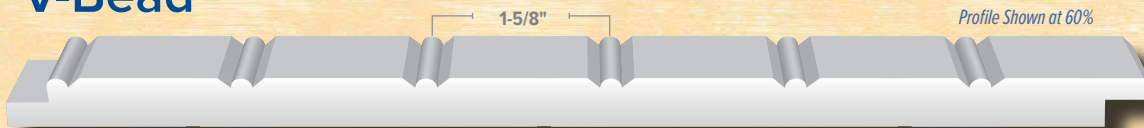

1-5/8" V-BEAD (9.6" FACE) 1 LINEAL FT = .80 SQ FT – ORDER IN 4 PIECE INCREMENTS

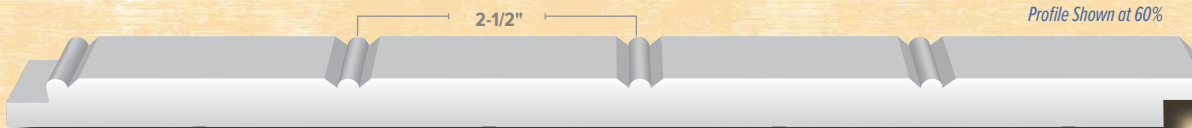

2-1/2" V-BEAD (10.104" FACE) 1 LINEAL FT = .842 SQ FT – ORDER IN 4 PIECE INCREMENTS

V-Groove



5-1/2" V-GROOVE (11" FACE) 1 LINEAL FT = .917 SQ FT – ORDER IN 4 PIECE INCREMENTS

All Shiplap Products are Quick Ship

THICKNESS	MDF	MRI/NAF	MRX	FR MDF
1/2"	8' 10' 12' 16'	8' 10' 16'	8'	8'

MRI = MOISTURE RESISTANT / NO ADDED FORMALDEHYDE ■ MRX = EXTERIOR MDF ■ FR= FIRE RATED (CLASS A)

WWW.GARDENSTATELUMBER.COM



- 1 **1/4" x 1/4" MODERN GROOVE (10" ON CENTER)**
- 2 **UC51, BB6**
- 3 **ECBCAP, BDB45**
- 4 **ECBCAP, 1x6**
- 5 **STANDARD BEAD 3" ON CENTER**
- 6 **LS6**
- 7 **BB7, 1X8, SH1**



- 1 **MCOV6, MCC312, MCS1**
- 2 **MC312, MCBB1**
- 3 **5/4" x 6" S4S, MSC275, MCS1**
- 4 **MCAP2, 1" x 4" S4S, 2-1/2"**
- 5 **V-BEAD PANELING**

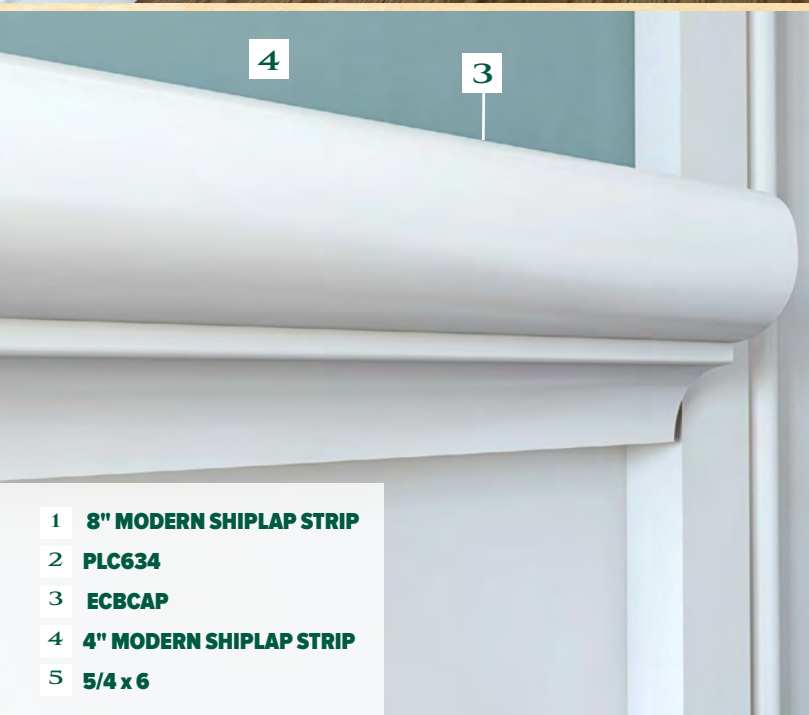

- 1 **8" MODERN SHIPLAP STRIP**
- 2 **PLC634**
- 3 **ECBCAP**
- 4 **4" MODERN SHIPLAP STRIP**
- 5 **5/4 x 6**

SHIPLAP STRIP PRODUCTS

3 WEEK LEAD TIME



Modern Shiplap Strip

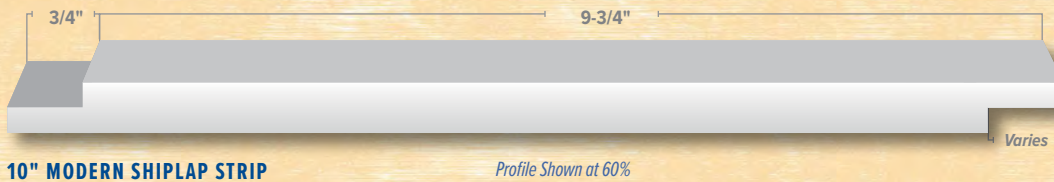
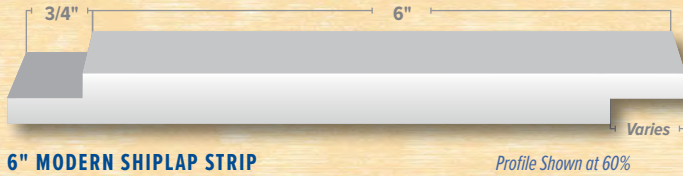

Specify your desired fit:

- Flush Fit
- 1/8" Groove
- 1/4" Groove

See details below

Flush Fit Detail

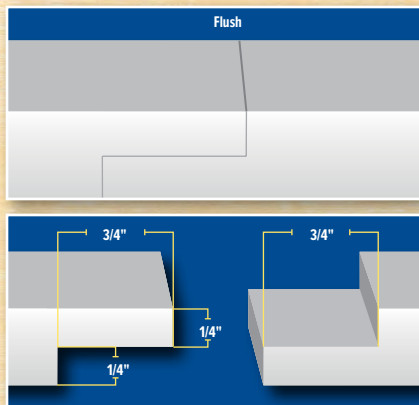

1/8" Groove Detail

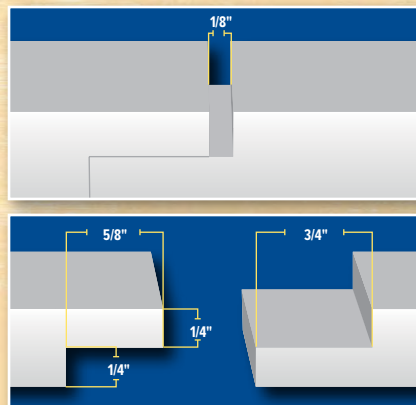

1/4" Groove Detail

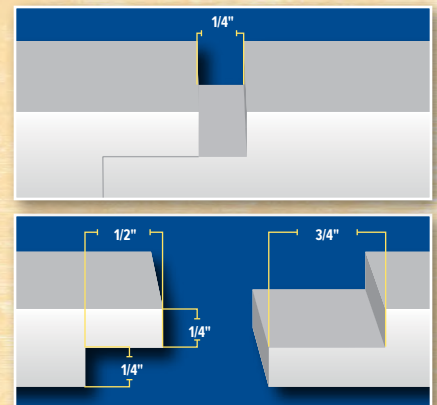

All Shiplap Products are Quick Ship

THICKNESS	MDF	MRI/NAF	MRX	FR MDF
1/2"	12' 16'	8' 10' 16'	8'	8'

SPECIAL ORDER SHEET PRODUCTS

4 WEEK LEAD TIME

Manufactured To Your Specified Distance On Center

If you are looking for something both unique and highly customizable, our special order products offer a wide variety of options.

- **Unique Selection Of Styles**
- **Manufactured To Your Desired Distance On Center**
- **Beads Run In Either 4' Or 8' Direction**
- **No Minimum Quantities**
- **Short Lead Times Of 4 Weeks**



Large V-Bead

4' x 8' Sheet Shown at 15%

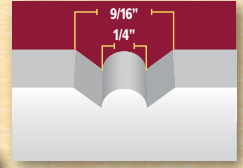

Jumbo V-Bead

4' x 8' Sheet Shown at 15%

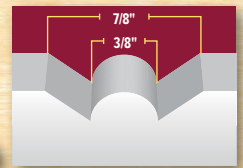

Large Standard Bead

4' x 8' Sheet Shown at 15%

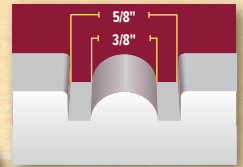

Jumbo Standard Bead

4' x 8' Sheet Shown at 15%

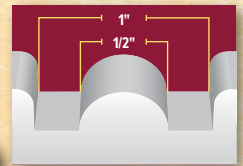

THICKNESS	MDF	MRI/NAF	MRX	FR MDF	PVC
1/2"	4' x 8' 4' x 10' 4' x 12'	4' x 8' 4' x 10'	4' x 8'	4' x 8'	4' x 8'

MRI = MOISTURE RESISTANT / NO ADDED FORMALDEHYDE ■ MRX = EXTERIOR MDF ■ FR= FIRE RATED (CLASS A)



WWW.GARDENSTATELUMBER.COM

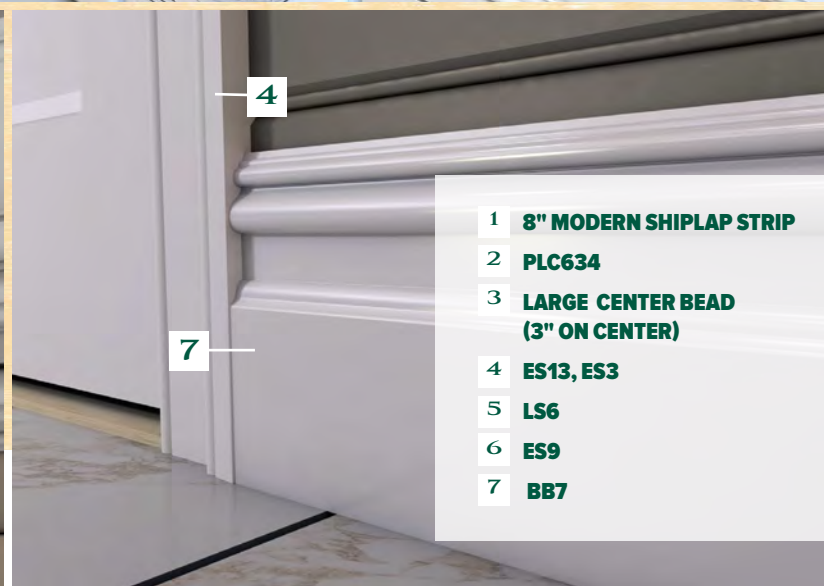

- 1 **8" MODERN SHIPLAP STRIP**
- 2 **PLC634**
- 3 **LARGE CENTER BEAD (3" ON CENTER)**
- 4 **ES13, ES3**
- 5 **LS6**
- 6 **ES9**
- 7 **BB7**

SPECIAL ORDER SHEET PRODUCTS

4 WEEK LEAD TIME

Manufactured To Your Specified Distance On Center

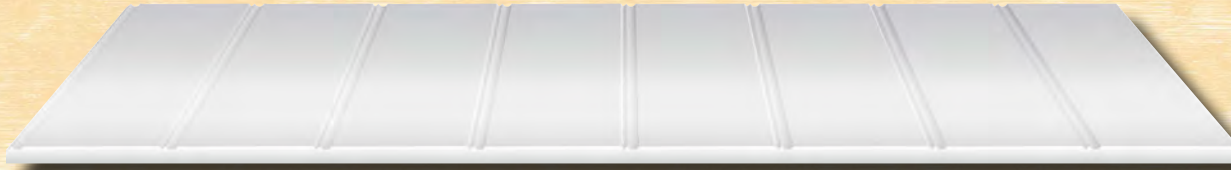

Cove Bead

4' x 8' Sheet Shown at 15%

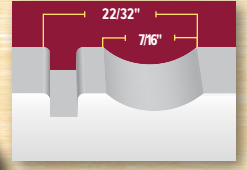

V-Channel

4' x 8' Sheet Shown at 15%

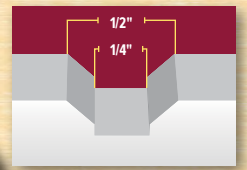

Butterfly

4' x 8' Sheet Shown at 15%

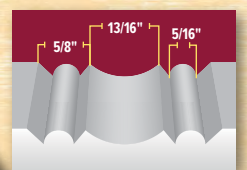

Large Butterfly

4' x 8' Sheet Shown at 15%

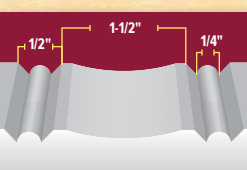

THICKNESS	MDF	MRI/NAF	MRX	FR MDF	PVC
1/2"	4' x 8' 4' x 10' 4' x 12'	4' x 8' 4' x 10'	4' x 8'	4' x 8'	4' x 8'

MRI = MOISTURE RESISTANT / NO ADDED FORMALDEHYDE ■ MRX = EXTERIOR MDF ■ FR= FIRE RATED (CLASS A)

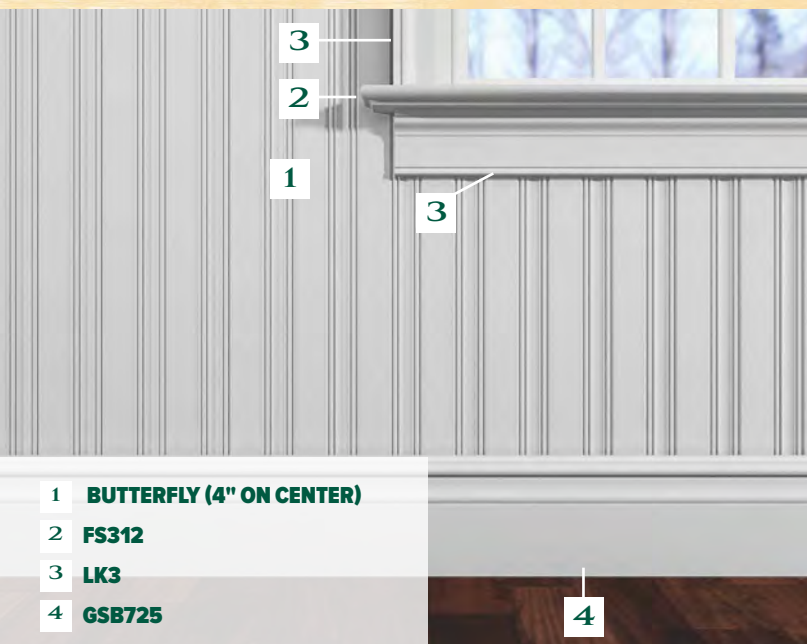

- 1 BUTTERFLY (4" ON CENTER)
- 2 FS312
- 3 LK3
- 4 GSB725

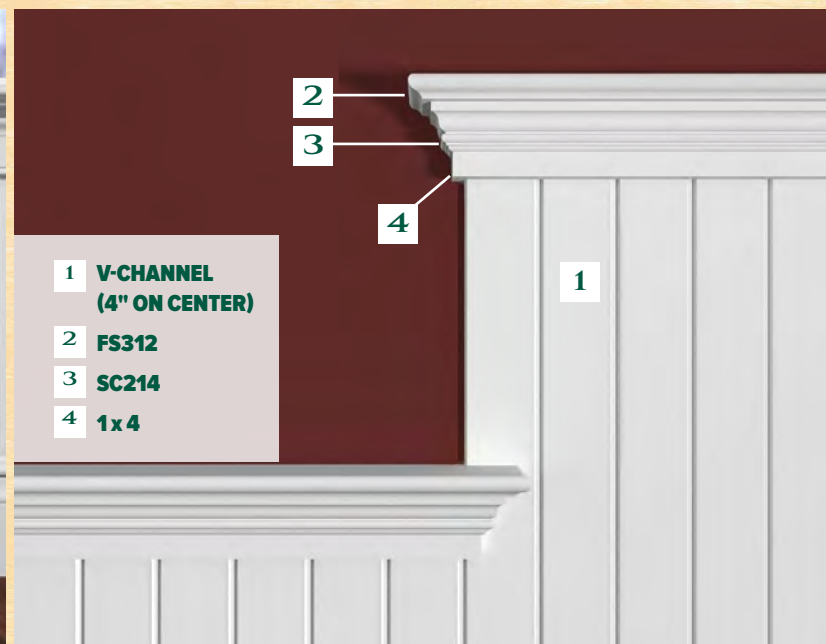

- 1 V-CHANNEL (4" ON CENTER)
- 2 FS312
- 3 SC214
- 4 1x4

WWW.GARDENSTATELUMBER.COM



DURABILITY

Echon's products won't pull moisture from the ground or any other surface, which makes it perfect for exterior applications.



LOW MAINTENANCE

Sealed edges and protective masking ensures that Echon's PVC products are easily kept clean.



QUALITY

From a consistent high density formulation to precision tight tolerance, get no less than the very best PVC.



PVC Trimboards

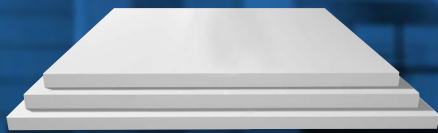

PVC Sheet Stock



PVC Mouldings

Now Available at





IN-STOCK

PVC TRIMBOARDS



SMOOTH

WOOD GRAIN

WHITE PVC TRIMBOARDS				
SKU	DESCRIPTION	PROFILE SIZE	LENGTH	AVAILABLE IN
D12PVC	1" x 2"	3/4" x 1-1/2"	18'	SMOOTH ONLY
D13PVC	1" x 3"	3/4" x 2-1/2"	18'	SMOOTH ONLY
D14PVC (W)	1" x 4"	3/4" x 3-1/2"	18'	SMOOTH & WOODGRAIN
D16PVC (W)	1" x 6"	3/4" x 5-1/2"	18'	SMOOTH & WOODGRAIN
D18PVC (W)	1" x 8"	3/4" x 7-1/4"	18'	SMOOTH & WOODGRAIN
D110PVC (W)	1" x 10"	3/4" x 9-1/4"	18'	SMOOTH & WOODGRAIN
D112PVC (W)	1" x 12"	3/4" x 11-1/4"	18'	SMOOTH & WOODGRAIN
D116PVC	1" x 16"	3/4" x 15-1/4"	18'	SMOOTH ONLY
D544PVC (W)	5/4" x 4"	1" x 3-1/2"	18'	SMOOTH & WOODGRAIN
D546PVC (W)	5/4" x 6"	1" x 5-1/2"	18'	SMOOTH & WOODGRAIN
D548PVC (W)	5/4" x 8"	1" x 7-1/4"	18'	SMOOTH & WOODGRAIN
D5410PVC (W)	5/4" x 10"	1" x 9-1/4"	18'	SMOOTH & WOODGRAIN
D5412PVC (W)	5/4" x 12"	1" x 11-1/4"	18'	SMOOTH & WOODGRAIN
D5416PVC	5/4" x 16"	1" x 15-1/4"	18'	SMOOTH ONLY
CRTX2-(S/WG)	2" Cortex PVC Fasteners	375 screws/plugs	250 LF of coverage	SMOOTH & WOODGRAIN
CRTX275-(S/WG)	2-3/4" Cortex PVC Fasteners	375 screws/plugs	250 LF of coverage	SMOOTH & WOODGRAIN

S4S WITH J-CHANNEL				
SKU	DESCRIPTION	PROFILE SIZE	LENGTH	AVAILABLE IN
D544JCPVC	5/4" x 4" W/ J-CHANNEL	1 x 3-1/2"	18'	SMOOTH ONLY
D546JCPVC	5/4" x 6" W/ J-CHANNEL	1 x 5-1/2"	18'	SMOOTH ONLY

WHITE PVC CORNER BOARDS				
SKU	DESCRIPTION	PROFILE SIZE	LENGTH	AVAILABLE IN
CB544PVC	5/4" x 4" Corner	1" x 3-1/2"	20'	SMOOTH ONLY
CB544JCPVC	5/4" x 4" J-Channel	1" x 3-1/2"	20'	SMOOTH ONLY
CB546PVC	5/4" x 6" Corner	1" x 5-1/2"	20'	SMOOTH ONLY
CB546JCPVC	5/4" x 6" J-Channel	1" x 5-1/2"	20'	SMOOTH ONLY

PVC SHEET STOCK

WHITE PVC SHEET STOCK						
THICKNESS	WIDTH	LENGTH				TEXTURE
		8'	10'	12'	18'	
1/4"	4'	●				SMOOTH
3/8"	4'	●	●			SMOOTH
1/2"	4'	●	●	●	●	SMOOTH
5/8"	4'	●				SMOOTH
3/4"	4'	●	●	●	●	SMOOTH
1"	4'	●	●	●	●	SMOOTH

WHITE PVC EDGE & CENTER BEAD					
SKU	DESCRIPTION	PROFILE SIZE	LENGTH	AVAILABLE IN	
ECB55PVC	1/2" x 6" Stealth ECB	1/2" x 5-1/2"	16'	SMOOTH ONLY	
12ECB6PVC	1/2" x 6" T&G ECB	1/2" x 5-1/2"	16'	SMOOTH ONLY	



WHITE PVC BEADBOARD SHEETS BY NANTUCKET BEADBOARD				
SKU	SIZE	DISTANCE ON CENTER	BEAD TYPE	AVAILABLE IN
SB158VB-PVC	1/2" X 4' X 8'	1-5/8"	V-BEAD	SMOOTH ONLY
SB212VB-PVC	1/2" X 4' X 8'	2-1/2"	V-BEAD	SMOOTH ONLY
SB2SB-PVC	1/2" X 4' X 8'	2"	STANDARD BEAD	SMOOTH ONLY
SB3SB-PVC	1/2" X 4' X 8'	3"	STANDARD BEAD	SMOOTH ONLY
SB6VG-PVC	1/2" X 4' X 8'	6"	V-GROOVE	SMOOTH ONLY



WHITE PVC MOULDINGS

IN-STOCK

CROWNS



L8027PVC

9/16 x 5-1/4

WM47PVC

11/16 x 4-5/8

LWM49PVC

9/16 x 3-5/8

WM53PVC

9/16 x 2-5/8



UC51PVC

11/16 x 5-5/8



BC5PVC

1-1/16 x 5-1/4



UC41PVC

11/16 x 4-5/8

Please note that mouldings are shown at 60% of their actual size.

WHITE PVC MOULDINGS

IN-STOCK

RAKE/ SOLID CROWNS



SC234PVC
1-3/8 x 2-3/4



RAMPVC
1-13/32 x 2
(Rams Crown)



RAKEPVC
1 x 2



WM210PVC
11/16 x 1-5/8

COVE/BED MOULDINGS

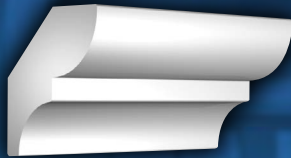

8016PVC
9/16 x 1-5/8



WM93PVC
3/4 x 3/4

NOSE & COVES



8578PVC
11/16 x 1-1/8



8577PVC
5/8 x 3/4

BASE CAPS

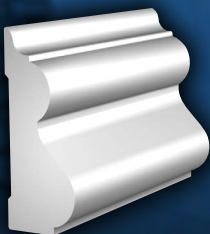

8416PVC
5/8 x 1-5/8

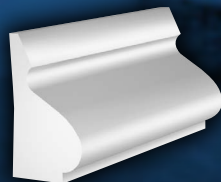

WM164PVC
11/16 x 1-1/8

QUARTER ROUND



8065PVC
3/4 x 3/4

PANEL

Rabbed Panel

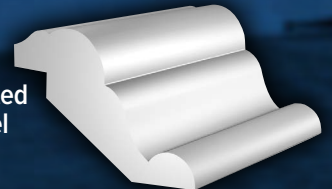

ES11PVC
1-1/8 x 1-3/4

Please note that mouldings are shown at 60% of their actual size.



WHITE PVC MOULDINGS

IN-STOCK

**EDGE & CENTER
BEAD CAP**

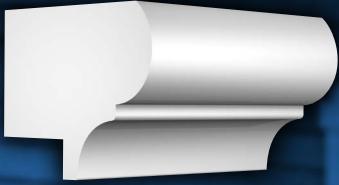

ECBCAPPVC
1-3/8 x 1-3/4

**BRICK
MOULD**



WM180PVC
1-1/4 x 2

**CASING /
CASING COMBINATIONS**



**BDB35PVC
with
138BBPVC**

DRIP CAP

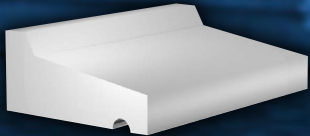

WM197PVC
1 1/16 x 1-5/8

BACKBAND



138BBPVC
1-3/8 x 1-3/8

BASES

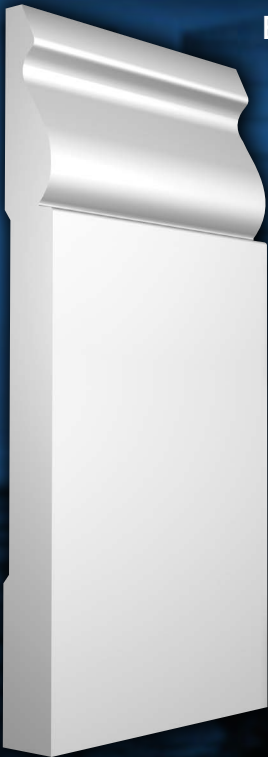

BB514PVC
9/16 x 5-1/4

CASING



BDB35PVC
3/4 x 3-1/2



WC1CTPVC
1-1/16 x 3-1/2



**BDB35PVC
with
ECBCAPPVC**



WC1CTPVC
1-1/16 x 3-1/2

Please note that mouldings are shown at 60% of their actual size.

WHITE PVC MOULDINGS

IN-STOCK

CORNER BOARDS



- CB544PVC**
1 x 3-1/2
- CB544JCPVC**
1 x 3-1/2
- CB546PVC**
1 x 5-1/2
- CB546JCPVC**
1 x 5-1/2

EDGE & CENTER BEADS

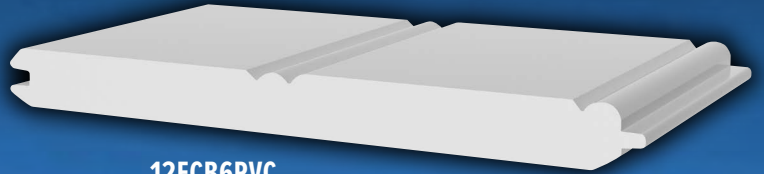

- 12ECB6PVC**
1/2 x 6 T&G
(1/2 x 5-1/2)



- ECB55PVC**
1/2 x 6 Edge and Center Bead (Stealth)
(1/2 x 5-1/2)

SILL/SILL NOSING

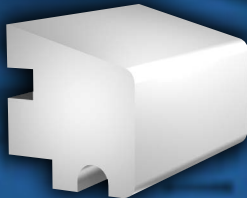

- SILL7118**
1-5/16 x 1-3/8



- SILL7117PVC**
1-1/4 x 5-1/4



- SILL7435PVC**
1-3/4 x 2-3/4

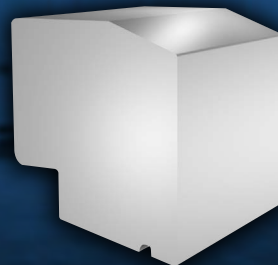

- SILL7650 (Historic Sill)**
1-3/4 x 2

Please note that mouldings are shown at 60% of their actual size.



PRE-FINISHED COLOR PVC

TRIM BOARDS, SHEET STOCK, MOULDINGS
AND BEADED PANEL PROGRAM

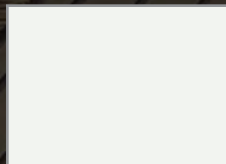

SMOOTH



WOOD GRAIN

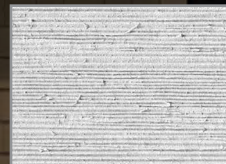

ROUGH SAWN

- Choose your **PVC TRIM BOARD** size and texture
(available in smooth, woodgrain, or rough sawn, 16' or 18')
- Choose your **PVC SHEET STOCK** size and texture
(smooth and wood grain only)
- Select your **PVC BEADED SHEETS**
- Select your **PVC MOULDINGS**
- Choose from any of our color recommendations
or select any PPG Paints color of your choosing
- Add **STARBORN PRO PLUGS SYSTEM**
*(boxes are 250 lineal foot of coverage
= 375 plugs / 375 screws)
* prefinished to your color selection*
- Add some **TOUCH UP PAINT**



PREFINISH IT

GET YOUR PVC PAINTED

Garden State Lumber now offers PVC mouldings, trim boards and sheet goods prefinished in any PPG Paints color of your choosing. Avoid the hassle and time of painting on-site and get a consistent, high quality manufacturer finish with a limited lifetime warranty.



GARDEN STATE LUMBER COLOR RECOMMENDATIONS

The following color recommendations have been carefully selected to match the most common siding and window manufacturer color palettes available in the market.



OR GET CUSTOM COLORS

We can pre-finish to any PPG Paints color of your choosing using the PPG color code.

** All pre-finished color PVC products finished on 3 sides, face and 2 edges*

** Garden State Lumber recommends ordering an additional cushion of 5-10% of material to make sure jobs needs are covered*

- The durability of NuCedar Trim color is achieved through a unique surface technology developed in conjunction with PPG Paints.
- NuCedar Trim's unique finish protects the PVC core against UV exposure, so that it never warps or twists in the sun.
- The water-based, solar-reflective coating is extremely durable and will not peel, crack or chip.
- NuCedar Trim carries a limited lifetime warranty on both the material and the finish.







NuCedar Mills®

finely crafted exteriors

NuCedar Shingles

13" & 18" ROUGHSAWN SHINGLES

AVAILABLE IN 14 STANDARD COLORS OR
CUSTOM PPG PAINT COLORS

ALL STANDARD COLORS IN STOCK FOR IMMEDIATE SHIPMENT

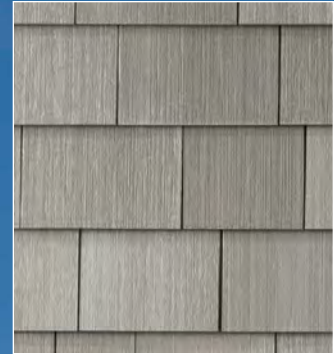

NuCedar Vertical Siding

CHANNEL RUSTIC | SHIPLAP | BOARD & BATTEN

SMOOTH & ROUGHSAWN

AVAILABLE IN 14 STANDARD COLORS OR
CUSTOM PPG PAINT COLORS



NuCedar Modern Shiplap

4", 6", 8", 10" EXPOSURE SHIPLAP

AVAILABLE IN SMOOTH & ROUGHSAWN

AVAILABLE IN 14 STANDARD COLORS) OR
CUSTOM PPG PAINT COLORS

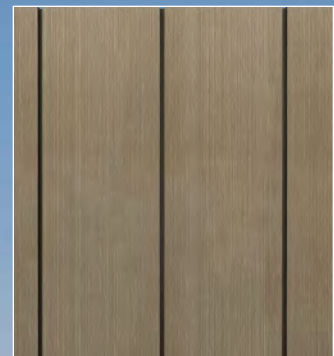





NuCedar Shingles in RoughSawn™—Argos



Available in 14 standard colors or custom PPG Paint colors

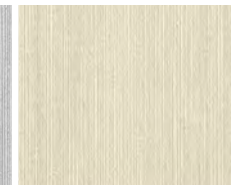

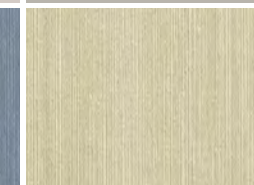
						
SUPER WHITE (NC-01)	WOOL SKEIN (NC-02)	BASKET BEIGE (NC-03)	ARGOS (NC-04)	ANTIQUE WHITE (NC-05)	WORLDLY GRAY (NC-06)	INTELLECTUAL GRAY (NC-07)
						
CEDAR (NC-08)	SVELTE SAGE (NC-09)	QUIVER TAN (NC-10)	ALEUTIAN BLUE (NC-11)	COASTAL PLAIN (NC-12)	BRACING BLUE (NC-13)	WHOLE WHEAT (NC-14)



NuCedar Mills[®]
finely crafted exteriors

NuCedar Shingles



ALL COLORS IN STOCK FOR IMMEDIATE SHIPMENT

NuCedar Shingles accurately capture the natural beauty and charm of precisely tapered, resquared, and rebuted cedar shingles. With no two shingles produced exactly the same, craftsmen are able to create the quilt-like patterns once only possible with natural cedar. Available in 14 traditional colors.



SKU	Shingles	Exposure	Thickness	Width	Box Qty	Colors
NCS13	13"	up to 5"	1/2"	4", 5", 6", 7", 8"	1/4 Square (25 Sq. Ft.)	All in stock
NCS18	18"	5-1/2" or 7"	1/2"	5", 6", 7", 8", 9"	1/4 Square (25 Sq. Ft.)	All in stock

***Please note 18" shingle should be installed at 5-1/2" or 7" exposure only**

*1 box = 1/4 square (4 box per square) based on 5" exposure for 13" shingle and 7" exposure for 18" shingle.

1 Square = 100 Sq Ft of coverage

ACCESSORIES



4oz Dauber of Paint

Touchup Paint

1 included with every 20 boxes (5 square)

SKU: PAINT-D



Matching Pint, Quart or Gallon of Paint

Pint: PAINT-P

Quart: PAINT-Q

Gallon: PAINT-G



PVC Adhesive for shingles/trim

SKU: PVCGLUE

INSTALLATION

NuCedar RoughSawn Shingles[™] are Manufactured from PVC making them resistant to the effects of salt air, weathering, and infestation. Our shingles outperform cedar in durability and color retention, and carry a **limited lifetime transferable warranty**.

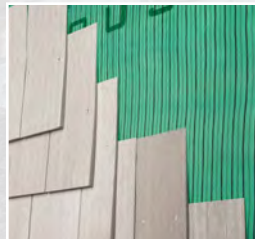

Installs just like traditional cedar shingles. Use exterior grade ring shank (5D Stainless) or siding nails or at least 7/16" wide crown stainless steel staples.

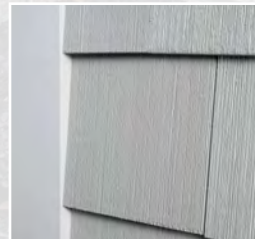

Utilizes Standard Trim and Corners.

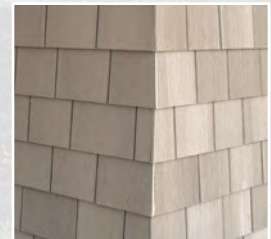

Alternate shingle courses on corners to create a "Boston Weave."

Timeless Beauty



NuCedar Shingles Fancy Cut Hexagonal—Worldly Gray



NuCedar Shingles Fancy Cut Diamond—Intellectual Gray



NuCedar Shingles Fancy Cut Diamond—Intellectual Gray

Available in 14 standard colors or custom PPG Paint colors

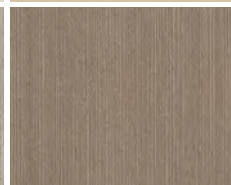
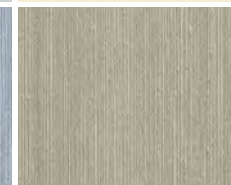
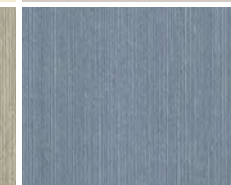

						
SUPER WHITE (NC-01)	WOOL SKEIN (NC-02)	BASKET BEIGE (NC-03)	ARGOS (NC-04)	ANTIQUE WHITE (NC-05)	WORLDLY GRAY (NC-06)	INTELLECTUAL GRAY (NC-07)
						
CEDAR (NC-08)	SVELTE SAGE (NC-09)	QUIVER TAN (NC-10)	ALEUTIAN BLUE (NC-11)	COASTAL PLAIN (NC-12)	BRACING BLUE (NC-13)	WHOLE WHEAT (NC-14)



FANCY CUTS

By **NuCedar Mills**
finely crafted exteriors

STEP INTO A WORLD OF ENDLESS POSSIBILITY WITH OUR NUCEDAR FANCY CUT SHINGLES

Mix & Match any of our 10 precision cut styles to achieve the architectural aesthetic your project requires

Special Order | *All shingles 5" wide at 13" or 18" | 8 boxes/sq (12.5 sq ft/box) | 13" = 72 pc / box | 18" = 52 pc/box

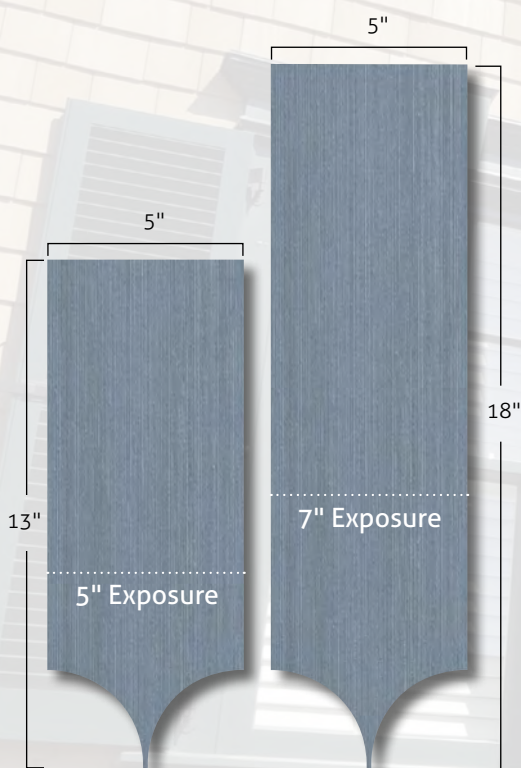

**18" Diamond pattern available
in 5" and 7" widths*

Arrow



Diagonal LH



Diagonal RH



*Diamond



Dog Ear



Fish Scale

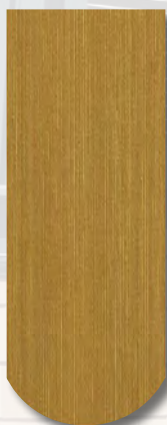

Half Cove



Hexagonal



Octagonal



Round



Timeless Beauty



NuCedar Board & Batten—Cedar

All Vertical Siding Available In



RoughSawn™

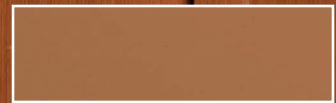

Smooth

LIMITED LIFETIME WARRANTY

NuCedar Vertical Siding is impervious to infestation and water, allowing it to run to grade without worry of rotting, decay, or other moisture-related concerns. Factory finished with a water-based coating from PPG Paints™ and backed by a limited lifetime transferable warranty, NuCedar Vertical Siding offers unmatched durability, low maintenance, and simple installation.

Available in 14 standard colors or custom PPG Paint colors



SUPER WHITE (NC-01)	WOOL SKEIN (NC-02)	BASKET BEIGE (NC-03)	ARGOS (NC-04)	ANTIQUE WHITE (NC-05)	WORLDLY GRAY (NC-06)	INTELLECTUAL GRAY (NC-07)
CEDAR (NC-08)	SVELTE SAGE (NC-09)	QUIVER TAN (NC-10)	ALEUTIAN BLUE (NC-11)	COASTAL PLAIN (NC-12)	BRACING BLUE (NC-13)	WHOLE WHEAT (NC-14)



NuCedar Mills
finely crafted exteriors

NuCedar Vertical Siding



SPECIAL ORDER. CONTACT US FOR CURRENT LEAD TIMES.

Whether used as an accent or as cladding on an entire home, NuCedar Mills' three vertical siding styles are designed to capture the historic character and rustic charm of architectural designs while offering an extended level of durability, low maintenance, and ease of installation. Available in 14 traditional color options.

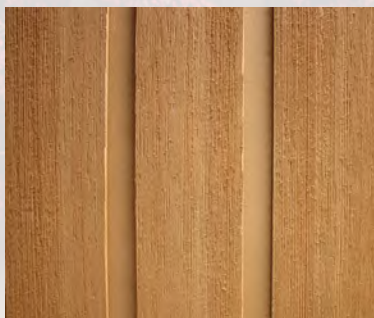

Channel Rustic *(Shown in Cedar Color NC-08)*

SKU	Dimension	Face Width	Channel Width	Length
RUSTIC6	5/8" x 5-1/2"	4"	1"	8', 10', 12', 16'
RUSTIC8	5/8" x 7-1/4"	5-3/4"	1"	8', 10', 12', 16'

4 oz of Touchup Paint supplied with every 6 Squares

* All Required Fasteners Are Included (Starborn Pro-plugs)

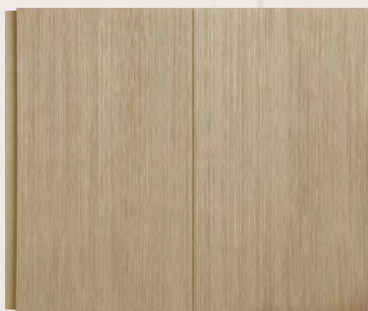
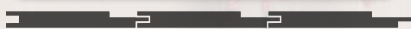

Tongue & Groove *(Shown in Basket Beige Color NC-03)*

SKU	Dimension	Face Width	Length
TG6	5/8" x 5-1/2"	5"	8', 10', 12', 16'
TG8	5/8" x 7-1/4"	6-3/4"	8', 10', 12', 16'

4 oz of Touchup Paint supplied with every 6 Squares

* All Required Fasteners Are Included (Starborn Pro-plugs)



Board & Batten *(Shown in Svelte Sage Color NC-09)*

SKU	Dimension	Length
BOARD	5/8" x 9-1/4"	8', 10', 12', 16'
BATTEN	3/4" x 2"	8', 10', 12', 16'

4 oz of Touchup Paint supplied with every 6 Squares

* All Required Fasteners Are Included (Starborn Pro-plugs)

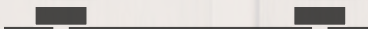

ACCESSORIES



PRO PLUG® -
375 2" Screws & Plugs
SKU: STARPVC-P



Matching Pint, Quart or Gallon of Paint

4oz Dauber: PAINT-D
Pint SKU: PAINT-P
Quart SKU: PAINT-Q
Gallon SKU: PAINT-G



PVC Adhesive for shingles/trim

SKU: PVCGLUE

Timeless Beauty



NuCedar Modern Shiplap in RoughSawn™—Intellectual Gray and Worldly Gray



NuCedar Modern Shiplap in RoughSawn™—Cedar

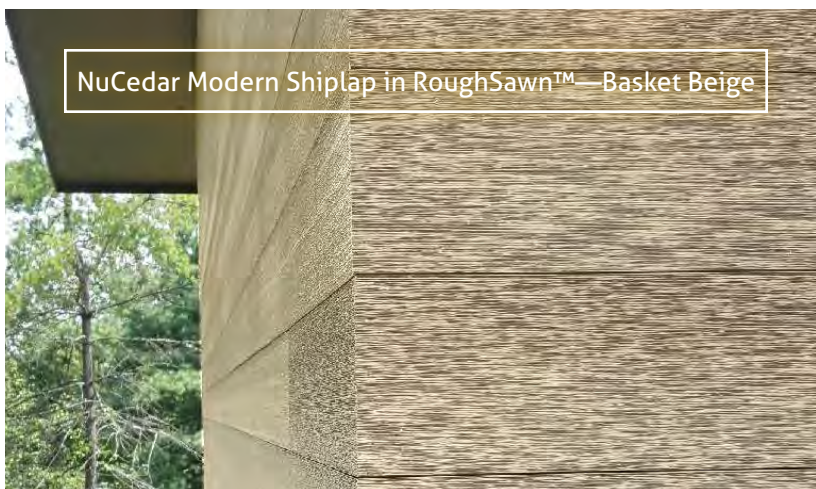

NuCedar Modern Shiplap in RoughSawn™—Basket Beige

Available in 14 standard colors or custom PPG Paint colors



						
SUPER WHITE (NC-01)	WOOL SKEIN (NC-02)	BASKET BEIGE (NC-03)	ARGOS (NC-04)	ANTIQUE WHITE (NC-05)	WORLDLY GRAY (NC-06)	INTELLECTUAL GRAY (NC-07)
						
CEDAR (NC-08)	SVELTE SAGE (NC-09)	QUIVER TAN (NC-10)	ALEUTIAN BLUE (NC-11)	COASTAL PLAIN (NC-12)	BRACING BLUE (NC-13)	WHOLE WHEAT (NC-14)



SPECIAL ORDER. CONTACT US FOR CURRENT LEAD TIMES.

NuCedar modern shiplap strips are the perfect marriage of rustic meets contemporary. With clean straight lines and multiple groove options, our shiplap products can be used in both a horizontal or vertical applications to achieve your desired aesthetic.

Flush	1/8" Groove	1/4" Groove	1/2" Groove	Dimensions	Face Width	Length
MSHIP4F	MSHIP4E	MSHIP4Q	MSHIP4H	5/8" x 4-3/4"	4"	8', 10', 12', 16'
MSHIP6F	MSHIP6E	MSHIP6Q	MSHIP6H	5/8" x 6-3/4"	6"	8', 10', 12', 16'
MSHIP8F	MSHIP8E	MSHIP8Q	MSHIP8H	5/8" x 8-3/4"	8"	8', 10', 12', 16'
MSHIP10F	MSHIP10E	MSHIP10Q	MSHIP10H	5/8" x 10-3/4"	10"	8', 10', 12', 16'

4 oz of Touchup Paint supplied with every 6 Squares * All Required Fasteners Are Included (Starborn Pro-plugs)

GROOVE OPTIONS



Flush

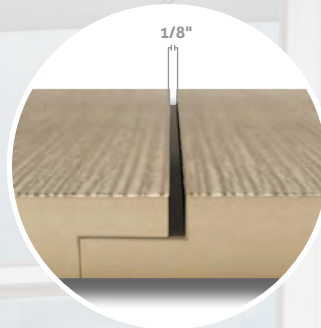

1/8" Groove

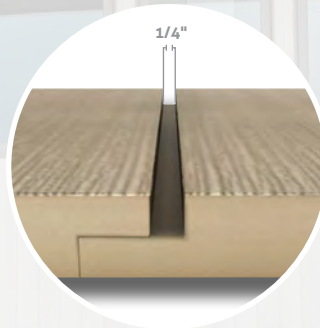

1/4" Groove

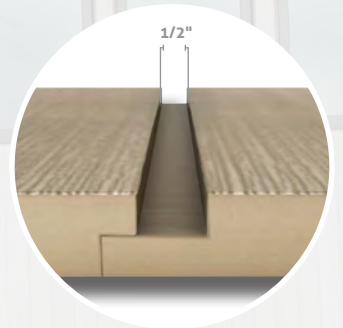

1/2" Groove



4" Shiplap

(Shown in Basket Beige Color NC-03, 1/4" Groove)



6" Shiplap

(Shown in Basket Beige Color NC-03, 1/4" Groove)

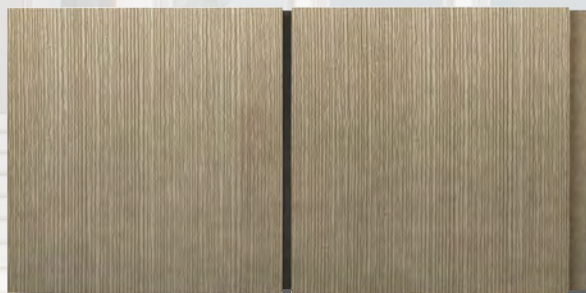

8" Shiplap

(Shown in Basket Beige Color NC-03, 1/4" Groove)



10" Shiplap

(Shown in Basket Beige Color NC-03, 1/4" Groove)

Timeless Beauty



Trim

S4S



J Pocket



Double
J Pocket



Grade
Plank



Edge &
Center Bead



SKU	Nominal Size	Actual Size	Length	Available In
S4S TRIMBOARD				
D12PVC-P	1" x 2"	3/4" x 1-1/2"	16' & 18'	Smooth / Woodgrain / Roughsawn
D13PVC-P	1" x 3"	3/4" x 2-1/2"	16' & 18'	Smooth / Woodgrain / Roughsawn
D14PVC-P	1" x 4"	3/4" x 3-1/2"	16' & 18'	Smooth / Woodgrain / Roughsawn
D15PVC-P	1" x 5"	3/4" x 4-1/2"	16' & 18'	Smooth / Woodgrain / Roughsawn
D16PVC-P	1" x 6"	3/4" x 5-1/2"	16' & 18'	Smooth / Woodgrain / Roughsawn
D18PVC-P	1" x 8"	3/4" x 7-1/4"	16' & 18'	Smooth / Woodgrain / Roughsawn
D110PVC-P	1" x 10"	3/4" x 9-1/4"	16' & 18'	Smooth / Woodgrain / Roughsawn
D112PVC-P	1" x 12"	3/4" x 11-1/4"	16' & 18'	Smooth / Woodgrain / Roughsawn
D116PVC-P	1" x 16"	3/4" x 15-1/4"	16' & 18'	Smooth / Woodgrain / Roughsawn
D544PVC-P	5/4" x 4"	1" x 3-1/2"	16' & 18'	Smooth / Woodgrain / Roughsawn
D546PVC-P	5/4" x 6"	1" x 5-1/2"	16' & 18'	Smooth / Woodgrain / Roughsawn
D548PVC-P	5/4" x 8"	1" x 7-1/4"	16' & 18'	Smooth / Woodgrain / Roughsawn
D5410PVC-P	5/4" x 10"	1" x 9-1/4"	16' & 18'	Smooth / Woodgrain / Roughsawn
D5412PVC-P	5/4" x 12"	1" x 11-1/4"	16' & 18'	Smooth / Woodgrain / Roughsawn
J-POCKET TRIM – WITH 3/4" x 3/4" DADO				
JTRIM4	5/4" x 4"	1" x 4"	18'	Smooth / Woodgrain / Roughsawn
JTRIM6	5/4" x 6"	1" x 5-1/2"	18'	Smooth / Woodgrain / Roughsawn
JTRIM8	5/4" x 8"	1" x 7-1/4"	18'	Smooth / Woodgrain / Roughsawn
JTRIM10	5/4" x 10"	1" x 9-1/4"	18'	Smooth / Woodgrain / Roughsawn
JTRIM12	5/4" x 12"	1" x 11-1/4"	18'	Smooth / Woodgrain / Roughsawn
DOUBLE J-POCKET TRIM – WITH 3/4" x 3/4" DADO 2 SIDES				
DJTRIM4	5/4" x 4"	1" x 4"	18'	Smooth / Woodgrain / Roughsawn
DJTRIM6	5/4" x 6"	1" x 5-1/2"	18'	Smooth / Woodgrain / Roughsawn
DJTRIM8	5/4" x 8"	1" x 7-1/4"	18'	Smooth / Woodgrain / Roughsawn
DJTRIM10	5/4" x 10"	1" x 9-1/4"	18'	Smooth / Woodgrain / Roughsawn
DJTRIM12	5/4" x 12"	1" x 11-1/4"	18'	Smooth / Woodgrain / Roughsawn
GRADE PLANK				
PLANK16	1" x 6"	3/4" x 5-1/2"	18'	Smooth / Woodgrain / Roughsawn
PLANK18	1" x 8"	3/4" x 7-1/4"	18'	Smooth / Woodgrain / Roughsawn
PLANK110	1" x 10"	3/4" x 9-1/4"	18'	Smooth / Woodgrain / Roughsawn
PLANK546	5/4" x 6"	1" x 5-1/2"	18'	Smooth / Woodgrain / Roughsawn
PLANK548	5/4" x 8"	1" x 7-1/4"	18'	Smooth / Woodgrain / Roughsawn
PLANK5410	5/4" x 10"	1" x 9-1/4"	18'	Smooth / Woodgrain / Roughsawn
EDGE & CENTER BEAD				
ECB55PVC-P	1/2" x 6"	1/2" x 5-1/2"	16'	Smooth
34ECB55PVC-P	3/4" x 6"	3/4" x 5-1/2"	16'	Smooth



Corners

Standard



J Corner



SKU	Corner	Nominal Size	Actual Size	Length	Available In
SCORNER4	Standard Corner	5/4" x 4"	1" x 3-1/2"	20'	Smooth / Woodgrain / Roughsawn
SCORNER6	Standard Corner	5/4" x 6"	1" x 5-1/2"	20'	Smooth / Woodgrain / Roughsawn
JCORNER	J Corner	5/4" x 6"	1" x 5-1/2"	20'	Smooth / Woodgrain / Roughsawn

Mouldings



NuCedar Colors



Available in 16 standard colors (2 trim only colors) or custom PPG Paint colors

SUPER WHITE (NC-01)	WOOL SKEIN (NC-02)	BASKET BEIGE (NC-03)	ARGOS (NC-04)	ANTIQUE WHITE (NC-05)	WORLDLY GRAY (NC-06)	INTELLECTUAL GRAY (NC-07)	CEDAR (NC-08)
SVELTE SAGE (NC-09)	QUIVER TAN (NC-10)	ALEUTIAN BLUE (NC-11)	COASTAL PLAIN (NC-12)	BRACING BLUE (NC-13)	WHOLE WHEAT (NC-14)	ANDERSEN GREEN (NCAG) <i>Trim Only</i>	WINEBERRY (NCWB) <i>Trim Only</i>

N O W S T O C K I N G

MELAMINE SHEETS & SHELVING

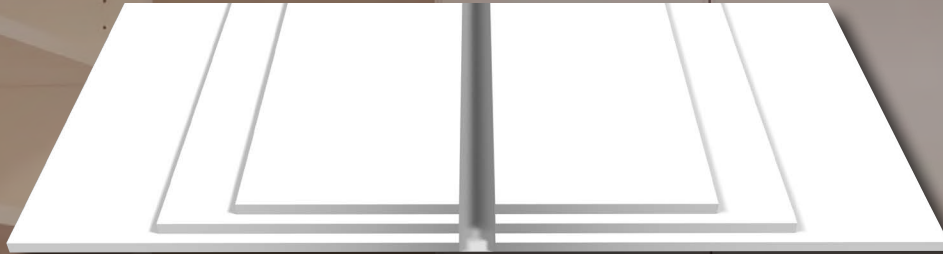

SHELVING

Edge Banded One Long Edge

3/4 X 12" (11-1/2") 8' AND 12' LENGTHS (34MEL12-8) (34MEL12-12)
3/4 X 16" (15-1/2") 8' AND 12' LENGTHS (34MEL16-8) (34MEL16-12)
3/4 X 24" (23-1/2") 8' AND 12' LENGTHS (34MEL24-8) (34MEL24-12)

PRE-DRILLED

3/4 X 16" (15-1/2") X 8' LENGTHS (34MEL16-8PD)

**SHELVING IS SQUARE EDGED

PRE-DRILLED SHELVING SPEC
HOLE DIAMETER IS 3/16"

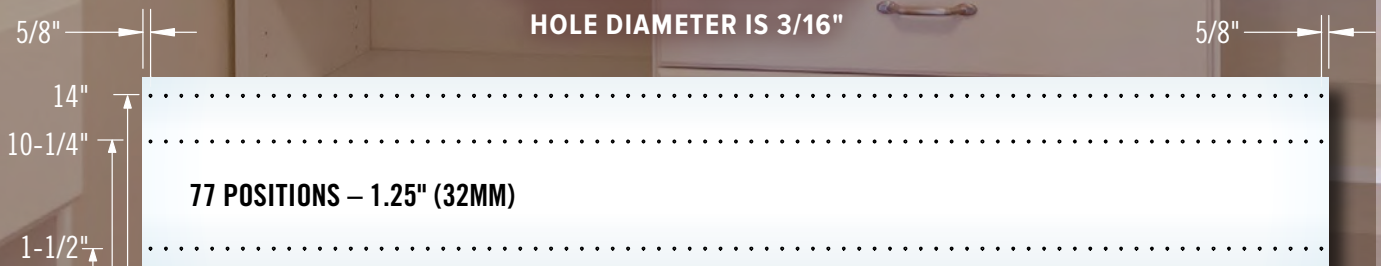

77 POSITIONS - 1.25" (32MM)



SHEETS

3/4 X 4 X 8 (49" X 97" WHITE 2 FACE) (34MEL4X8)

- Please call for pricing -

WWW.GARDENSTATELUMBER.COM



Our Platinum XL line is the newest edition to our family of interior/exterior S4S trim boards. Made from a clear finger-joint Radiata substrate and vacuum coated with 2 passes of exterior bright white, acrylic latex water based primer, the Platinum XL line is ideal for both interior and exterior applications.

AVAILABLE IN 12' AND 16' LENGTHS IN BOTH UNIT AND LESS THAN UNIT QUANTITIES:

1/2 x 2* (1/2 x 1-1/2) (D1PRF)	5/4 x 4 (1-1/8 x 3-1/2) (LTX544PRF)
1/2 x 3* (1/2 x 2-1/2) (D2PRF)	5/4 x 6 (1-1/8 x 5-1/2) (LTX546PRF)
1/2 x 4* (1/2 x 3-1/2) (D3PRF)	5/4 x 8 (1-1/8 x 7-1/4) (LTX548PRF)
1/2 x 6* (1/2 x 5-1/2) (D4PRF)	5/4 x 10* (1-1/8 x 9-1/4) (LTX5410PRF)
1/2 x 8* (1/2 x 7-1/4) (D5PRF)	5/4 x 12* (1-1/8 x 11-1/4) (LTX5412PRF)
1 x 2* (3/4 x 1-1/2) (LTX12PRF)	T&G V-GROOVE:
1 x 3* (3/4 x 2-1/2) (LTX13PRF)	1 x 4 ECB* (9/16 x 3-1/2) (ECB4PRF)
1 x 4 (3/4 x 3-1/2) (LTX14PRF)	1 x 6 ECB* (3/4 x 5-1/2) (ECB6PRF)
1 x 6 (3/4 x 5-1/2) (LTX16PRF)	1 x 8* (3/4 x 7-1/4) (VG725PRF)
1 x 8 (3/4 x 7-1/4) (LTX18PRF)	NICKEL GAP:
1 x 10 (3/4 x 9-1/4) (LTX110PRF)	1 x 6* (3/4 x 5-1/2) (NG512PRF)
1 x 12 (3/4 x 11-1/4) (LTX112PRF)	1 x 8* (3/4 x 7-1/4) (NG714PRF)
	1 x 10* (3/4 x 9-1/4) (NG914PRF)

**Only Available in 16' lengths*



Garden State Lumber Products would like to introduce PLATINUM PROTECTED, the newest member of our ever-expanding offering of S4S trimboards. Providing unparalleled protection against rot, fungus, mold, mildew, and even termites, PLATINUM PROTECTED stands apart from other trim products for its multi-phase protection process that covers all four sides of the substrate and ensures the ultimate in defense against the natural environment. Merging the industry's highest quality Radiata substrate by CMPC Maderas with the expertise of the FrameGuard® Total treatment system and Garden State Lumber's proprietary Two-Coat priming system, PLATINUM PROTECTED is the new standard for environmentally friendly treated S4S Trimboards.



AVAILABLE IN 16' LENGTHS ONLY IN BOTH UNIT AND LESS THAN UNIT QUANTITIES

1 x 3 (3/4 x 2-1/2) (XLP13PRF)	5/4 x 4 (1-1/8 x 3-1/2) (XLP544PRF)
1 x 4 (3/4 x 3-1/2) (XLP14PRF)	5/4 x 6 (1-1/8 x 5-1/2) (XLP546PRF)
1 x 5 (3/4 x 4-1/2) (XLP15PRF)	5/4 x 8 (1-1/8 x 7-1/4) (XLP548PRF)
1 x 6 (3/4 x 5-1/2) (XLP16PRF)	5/4 x 10 (1-1/8 x 9-1/4) (XLP5410PRF)
1 x 8 (3/4 x 7-1/4) (XLP18PRF)	5/4 x 12 (1-1/8 x 11-1/4) (XLP5412PRF)
1 x 10 (3/4 x 9-1/4) (XLP110PRF)	EDGE & CENTER BEAD:
1 x 12 (3/4 x 11-1/4) (XLP112PRF)	1 x 6 ECB (3/4 x 5-1/2) (XLP546PRF)
SHIPLAP:	V-GROOVE:
1 x 6 (3/4 x 5-1/2) (SL6PRF)	1 x 6 (3/4 x 5-1/2) (VG6PRF)
1 x 8 (3/4 x 7-1/4) (SL8PRF)	



S4S SELECT STOCK

SKU	NOMINAL	ACTUAL SIZE	 PRIMED ULTRALITE MDF	 PVC BOARDS	 SOLID PINE	 PRIMED PINE 30 YEAR WARRANTY
D1	1/2 x 2	1/2 x 1-1/2			D1	
D2	1/2 x 3	1/2 x 2-1/2			D2	
D3	1/2 x 4	1/2 x 3-1/2			D3	
D4	1/2 x 6	1/2 x 5-1/2			D4	
D5	1/2 x 8	1/2 x 7-1/4				
D12	1 x 2	3/4 x 1-1/2			D12	
D13	1 x 3	3/4 x 2-1/2			D13	XLP13PRF
D14	1 x 4	3/4 x 3-1/2	D14MDF	D14PVC	D14	XLP14PRF
D15	1 x 5	3/4 x 4-1/2				XLP15PRF
D16	1 x 6	3/4 x 5-1/2	D16MDF	D16PVC	D16	XLP16PRF
D18	1 x 8	3/4 x 7-1/4	D18MDF	D18PVC	D18	XLP18PRF
D110	1 x 10	3/4 x 9-1/4	D110MDF	D110PVC	D110	XLP110PRF
D112	1 x 12	3/4 x 11-1/4	D112MDF	D112PVC	D112	XLP112PRF
D116	1 x 16	3/4 x 15-1/4		D116PVC		
D542	5/4 x 2	1-1/8 x 1-1/2			D542	
D543	5/4 x 3	1-1/8 x 2-1/2			D543	
D544	5/4 x 4	1-1/8 x 3-1/2		D544PVC*	D544	XLP544PRF
D546	5/4 x 6	1-1/8 x 5-1/2		D546PVC*		XLP546PRF
D548	5/4 x 8	1-1/8 x 7-1/4		D548PVC*		XLP548PRF
D5410	5/4 x 10	1-1/8 x 9-1/4		D5410PVC*		XLP5410PRF
D5412	5/4 x 12	1-1/8 x 11-1/4		D5412PVC*		XLP5412PRF
D5416	5/4 x 16	1 x 15-1/4		D5416PVC*		
D844	8/4 x 4	1-1/2 x 3-1/2				
D846	8/4 x 6	1-1/2 x 5-1/2				
D848	8/4 x 8	1-1/2 x 7-1/4				
D8412	8/4 x 12	1-1/2 x 11-1/4				

*5/4 BOARDS ARE ACTUAL 1" THICKNESS

S4S SELECT STOCK



 PRIMED PINE (PRIMED FJ)	 PRIMED POPLAR (PRIMED FJ)	 HARDWOODS POPLAR RED OAK WHITE OAK MAPLE CHERRY SAPELE WALNUT	ACTUAL SIZE	NOMINAL	SKU
D1PRF			1/2 x 1-1/2	1/2 x 2	D1
D2PRF			1/2 x 2-1/2	1/2 x 3	D2
D3PRF			1/2 x 3-1/2	1/2 x 4	D3
D4PRF			1/2 x 5-1/2	1/2 x 6	D4
D5PRF			1/2 x 7-1/4	1/2 x 8	D5
LTX12PRF		D12 POP / OAK / WO / MA / SAP / WAL	3/4 x 1-1/2	1 x 2	D12
LTX13PRF	D13PP	D13 POP / OAK / WO / MA / SAP / WAL	3/4 x 2-1/2	1 x 3	D13
LTX14PRF	D14PP	D14 POP / OAK / WO / MA / CH / SAP / WAL	3/4 x 3-1/2	1 x 4	D14
LTX15PRF		D15POP	3/4 x 4-1/2	1 x 5	D15
LTX16PRF	D16PP	D16 POP / OAK / WO / MA / CH / SAP / WAL	3/4 x 5-1/2	1 x 6	D16
LTX18PRF	D18PP	D18 POP / OAK / WO / MA / CH / SAP / WAL	3/4 x 7-1/4	1 x 8	D18
LTX110PRF	D110PP	D110 POP / OAK / WO / MA / CH / SAP / WAL	3/4 x 9-1/4	1 x 10	D110
LTX112PRF	D112PP	D112 POP / OAK / WO / MA / CH / SAP / WAL	3/4 x 11-1/4	1 x 12	D112
	D116PP		3/4 x 15-1/4	1 x 16	D116
			1-1/8 x 1-1/2	5/4 x 2	D542
			1-1/8 x 2-1/2	5/4 x 3	D543
LTX544PRF	D544PP*	D544 POP / OAK / WO / MA / SAP*	1-1/8 x 3-1/2	5/4 x 4	D544
LTX546PRF	D546PP*	D546 POP / OAK / WO / MA / SAP*	1-1/8 x 5-1/2	5/4 x 6	D546
LTX548PRF	D548PP*	D548 POP / OAK / WO / MA / SAP*	1-1/8 x 7-1/4	5/4 x 8	D548
LTX5410PRF	D5410PP*	D5410 POP / OAK / SAP*	1-1/8 x 9-1/4	5/4 x 10	D5410
LTX5412PRF	D5412PP*	D5412 POP / OAK / SAP*	1-1/8 x 11-1/4	5/4 x 12	D5412
			1 x 15-1/4	5/4 x 16	D5416
		D844 POP / OAK / SAP	1-1/2 x 3-1/2	8/4 x 4	D844
		D846 POP / OAK / SAP	1-1/2 x 5-1/2	8/4 x 6	D846
		D848 POP / OAK / SAP	1-1/2 x 7-1/4	8/4 x 8	D848
		D8412 POP / OAK / SAP	1-1/2 x 11-1/4	8/4 x 12	D8412

*5/4 BOARDS ARE ACTUAL 1" THICKNESS

NORTHEAST REGION:
PHONE: (800)526-4708



SOUTHEAST REGION:
PHONE: (800)296-0288

SHEET STOCK — AND — PANEL PRODUCTS



**IN STOCK FOR
IMMEDIATE SHIPMENT**

NO MINIMUM QUANTITIES

THICKNESS	SHEET SIZE	 ULTRALITE MDF	medex MOISTURE RESISTANT MDF	 <small>Always reliable</small> the cmcpc PLYWOOD RADIATA A/C PLY	LUAN PLYWOOD
1/8"	4' x 8'	18MDF*			18LUAN
1/4"	4' x 8'	14MDF*		14AC	14LUAN52 & 14LUAN55
3/8"	4' x 8'	38MDF		38AC/38BP	
	4' x 10'				
1/2"	4' x 8'	12MDF		12AC	12LUAN
	4' x 10'	12MDF10			
	4' x 12'	12MDF12			
	4' x 18'				
5/8"	4' x 8'	58MDF		58AC/58T11	
	4' x 8'	34MDF	34MDF-MRI	34AC	34LUAN
3/4"	4' x 10'	34MDF10			
	4' x 12'	34MDF12			
	4' x 16'	34MDF16			
	4' x 18'				
1"	4' x 8'	1MDF		1AC	
	4' x 10'				
	4' x 12'				
	4' x 18'				
1-1/4"	4' x 8'	54MDF			
1-1/2"	4' x 8'	64MDF			

*LITE MDF 40 LB/CUBIC FT

RADIATA A/C PLY

3/8" Available In Beaded Ply - 2" on Center,
5/8" Available in Texture 111 - 8" on Center

SHEET STOCK — AND — PANEL PRODUCTS



**IN STOCK FOR
IMMEDIATE SHIPMENT**

NO MINIMUM QUANTITIES

nantucket® beardboard MDF BEADBOARD (5 PATTERNS)	PRECISION PLYWOOD SHEETS BIRCH OAK	AROMATIC CEDAR CHIPBOARD	NuCedar Trim finely crafted exteriors PVC SHEETS	SHEET SIZE	THICKNESS			
●	14BIR / 140AK	CEDARCB	14PVC	4' x 8'	1/8"			
			38PVC	4' x 8'	1/4"			
● ● ●	12BIR / 120AK		38PVC10	4' x 10'	3/8"			
			12PVC	4' x 8'	1/2"			
			12PVC10	4' x 10'				
			12PVC12	4' x 12'				
				12PVC18	4' x 18'	5/8"		
				58PVC	4' x 8'			
				34BIR / 34BIRUV2S / 340AK		34PVC	4' x 8'	3/4"
						34PVC10	4' x 10'	
						34PVC12	4' x 12'	
						34PVC18	4' x 18'	
			1PVC	4' x 8'	1"			
			1PVC10	4' x 10'				
			1PVC12	4' x 12'				
			1PVC18	4' x 18'				
				4' x 8'	1-1/4"			
				4' x 8'	1-1/2"			

MDF BEADBOARD
Also Available in PVC &
Moisture resistant MDF

PREMIUM BIRCH
1/4" = C3 Grade, 1/2" = C2 Premium,
34BIR = C2 Classic Birch
34BIRUV2S = Prefinished U.V. Coated 2 Sides

AROMATIC CEDAR CHIPBOARD
1/4" x 4' x 8'

PREMIUM
GS
MILLWORK

ARCHITECTURAL
WOOD PRODUCTS

*"Quality is remembered
long after price is forgotten"*



VOLUME 13

Introducing
the GSL App!

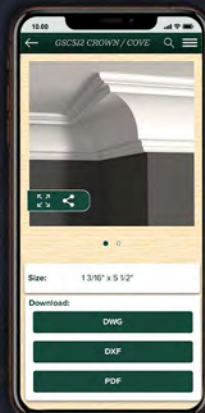
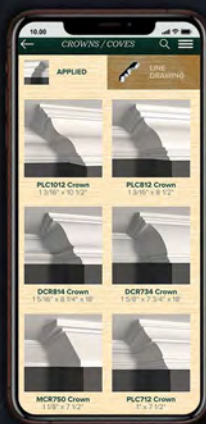

NORTHEAST REGION:
22 MULLER ROAD, OAKLAND, NJ 07436
PHONE: (800)526-4708

SOUTHEAST REGION:
810 BISTLINE DRIVE, WEST COLUMBIA, SC 29172
PHONE: (800)296-0288

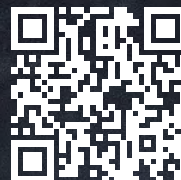

Available on the
App Store

Get it on
Google play

\$11.11

WWW.GARDENSTATELUMBER.COM